



**2023**  
WORKBOOK



# ANYWHERE ADVENTURE ABOUNDS

Since 1990, Sea to Summit has been your ally in every adventure—whether that’s on the deck of your sailboat or on a high-altitude expedition.

Designed to be the perfect balance of clever, packable and light, our award-winning products encourage self-reliance on any terrain.

Our love of the outdoors and our relentless pursuit of design perfection is what drives us. That’s why you can find our gear in the backpacks of explorers everywhere—from our home in Western Australia to the snowy mountains of Europe and the vast trails of North America.



# FOUNDER STORY

Roland Tyson started making outdoor gear on an old industrial sewing machine in his childhood bedroom in 1983 at the age of 17.

As a young outdoor enthusiast, Roland had a passion and a talent for creating cutting-edge outdoor equipment for his own adventurers, and soon for other Australian adventurers.

By 1991, after outfitting an unusual first ascent of Mt. Everest (a 1126+ kilometre, 8848 metres in elevation trek from sea level to a solo summit), Sea to Summit was born.

Roland's drive to design the best, lightest and most durable equipment would take him farther into the remote Australian outback and eventually into the Himalayas. In these wild places, he could put his inventions to the ultimate test.

In 1993, Roland was joined by Penny Sanderson, who had spent six years at Australian Geographic. Her passion for exploration and innovation was a perfect fit for Sea to Summit. She and Roland began travelling several months out of each year, spending time climbing, sailing, trekking, overlanding and biking. Everywhere they went, they tested products and iterated design.

Sea to Summit quickly grew into a successful global brand, with Penny and Roland's love of travel and design as the foundation. Together, they own and manage Sea to Summit, still taking part in every step of the journey from developing raw materials to putting perfected gear into the hands of customers worldwide.

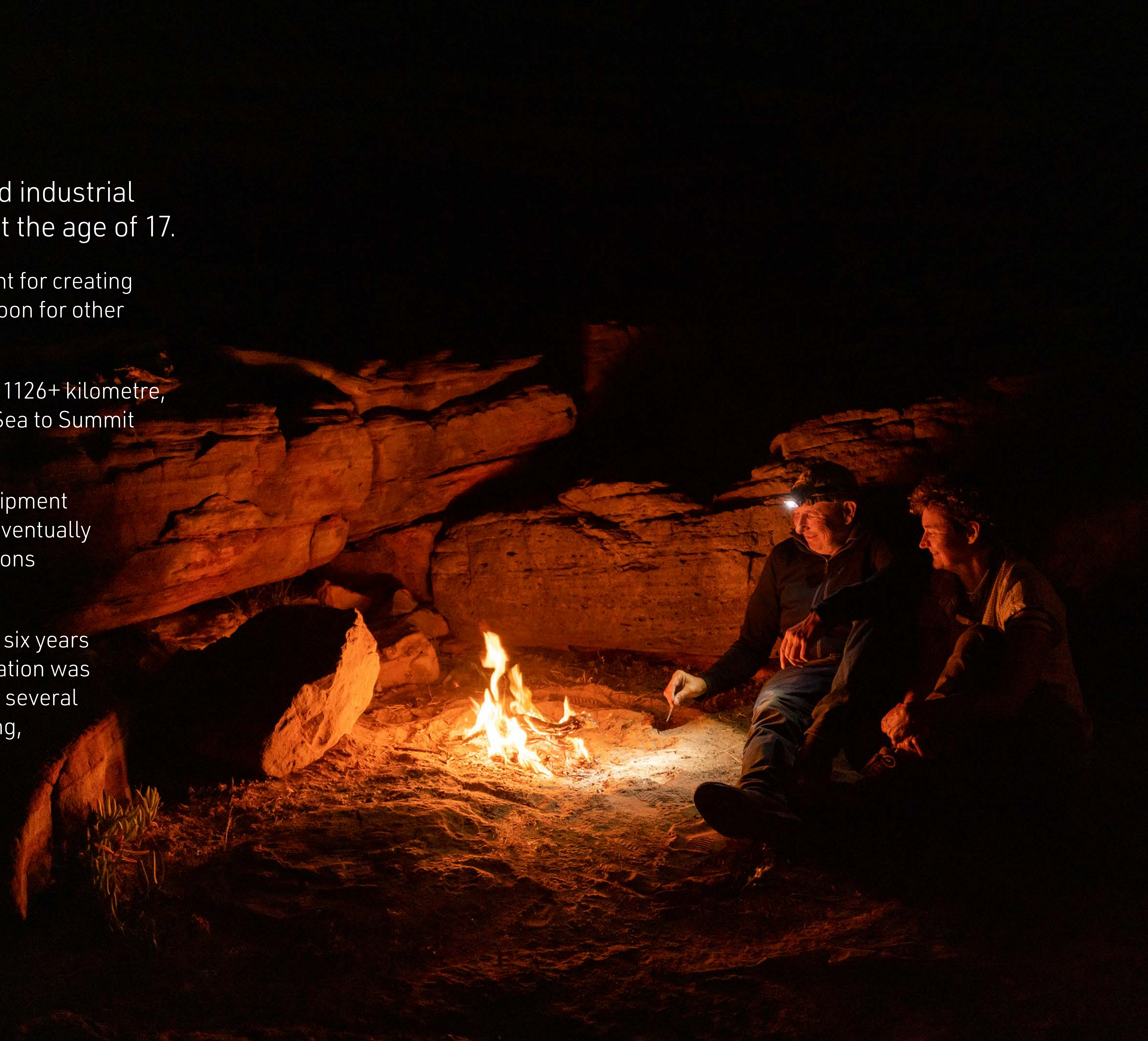



# SUSTAINABILITY

Our love of the outdoors is what drives innovation, exploration and adventure. It also compels us to make meaningful steps towards improving our environmental and social impact.

We are surfers, hikers, bikers, paddlers, sailors—lovers of outdoor spaces and we are inspired by the freedom those spaces provide. Stewardship of our natural environment is as important to us as the creation of new products, and we purposefully make gear that lasts and can be easily repaired.

We often do things or take actions because we just know it's the right thing to do—and then forget to ever mention what we've done. Like our head office in Perth, Western Australia being purpose-built to be energy efficient and having a 40KW capacity solar system that offsets our energy consumption.

Acknowledging we can do better, we have begun a major project to understand how our brand impacts our global environment, so that we can better guide our future actions to reduce our carbon footprint. This project includes estimating our Scope 1, 2 and 3 carbon emissions by mid-2022.

At Sea to Summit, we invent gear that enables freedom and self-reliance in any environment—and we believe it is imperative that same environment be around for future generations of adventurers to enjoy.

The meaningful steps we are making towards improving our environmental and social impact and our commitment to being transparent about our progress is the only way to guarantee we do our part in making that happen.

## Easily Recyclable Packaging

We approach packaging design as we do product—with meticulous attention to detail.

Seeking better solutions is an ongoing challenge, and it's why we've recently undergone the most significant packaging review in our three decades of operation.

The outcome will see us transition all packaging to responsibly sourced card-based and easily recyclable materials, reducing single-use plastic and maximising carton-efficiency across our entire product line by 2025.

We've also adopted the world-leading Australasian Recycling Label (ARL) Program icons. Much like the US-based How2Recycle, this Program is an on-pack labelling scheme that provides clear and simple instructions on how to recycle all of the separable packaging components, encouraging responsible consumer behaviour.

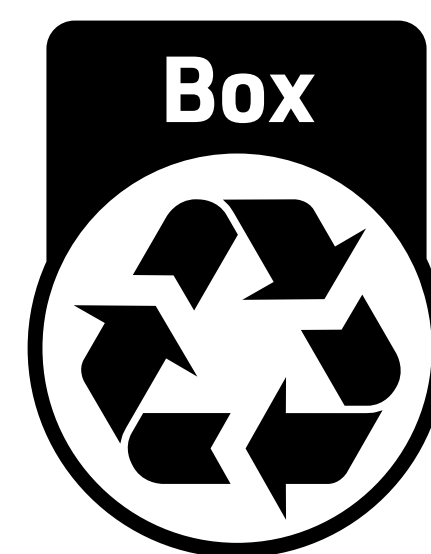

arl.org.au



## Sustainable Product Design

We are striving to reduce the environmental impact of our products by increasing the use of recycled materials, choosing better chemistry through our commitment to bluesign® APPROVED fabrics and transitioning to C0 non-PFC water repellent finishes.

You'll see these sustainable design attributes throughout our product pages from C0 non-PFC DWR finishes on our gaiters, sleeping bags, Ikos tents and storage solutions; recycled polyester in our DRY+ towels and traceable recycled nylon and bluesign® APPROVED fabrics introduced to our updated storage range.

We've set ambitious goals for ourselves, and we will continue communicating our progress.



## Better Chemistry

Producing high-spec, performance fabrics requires chemicals.

By choosing bluesign® APPROVED fabrics we are ensuring the chemicals used meet the strict consumer safety and environmental requirements of the bluesign® CRITERIA and are produced in a resource conserving way. We have committed to 100% bluesign® APPROVED textiles by 2030.

Most sleeping bags and gaiters have already transitioned to C0 non-PFC water repellent finishes and in 2023, our tents and storage will join them. Our goal is to use 100% C0 non-PFC water repellent finishes by 2025.



## Responsibly Sourced Down

Sea to Summit is certified to the Responsible Down Standard (RDS) and 100% of the down used in our sleeping bags and quilts is independently certified to the RDS. The RDS certifies down against animal welfare requirements and tracks it from the source to the final product. Our ULTRA-DRY Down treatment is also C0 non-PFC.



## Recycled Materials

By switching to recycled content, we are limiting our dependence on virgin raw materials and reducing the carbon footprint of our products.

Our DRY+ towels already use recycled polyester and in 2023, we are transitioning all of our recycled 70D lightweight nylon to be independently certified to the Recycled Claim Standard (RCS). The RCS verifies the recycled nylon and tracks it from the source to the final product.

We have committed to a goal of 90% Primary and 50% Secondary Materials be recycled, bio-based or otherwise sustainable by 2030.



## Easy-Care for Longevity

Sustainable product design starts with engineering long-lasting and easily repairable products—care and maintenance then extend the usable life.

Many of our products include or have readily available components to enable simple repairs and we provide them at no charge (or nominal cost) to end-users in an effort to keep usable product out of landfill. We also help educate customers on caring for their gear to keep it functioning at its best, for longer. Check out [Product Care](#) on our website.

## Care For Our People

Much like our products—we build relationships that last.

It's important to us that we take care of the people who work for Sea to Summit and the people who make our products, which is why we're committed to fair labour practices in our supply chain.

Our Product Creation and Supply teams partner with our local suppliers and third-party auditors to confirm compliance with our factory Code of Conduct, which aligns with the internationally recognised SA8000 Social Accountability Labour Standard.

## How We Give Back

We support non-profits that preserve the places we play and that enable more people to get out and enjoy nature. We've had decade-plus relationships with many organisations; others are new to us—all are positively impacting people and the planet. These are some of the organisations we currently support:



# WARRANTIES



## Sea to Summit Guarantee

We stand behind our products and strive to exceed expectations.

For over 30 years, Sea to Summit has designed and built award-winning gear that's continuously tested in the Australian outback and demanding environments around the world.

We guarantee our products against manufacturing defects within a reasonable time from purchase—and we strive to keep the claim process straightforward.

Customer satisfaction is our ultimate priority. While we advocate, educate and promote simple care and maintenance to extend a product's usable life, in instances of a manufacturing defect we replace, repair, or provide credit for the item. This is assessed on an individual, case-by-case basis.

Put simply, we always do what we know is right to build products and relationships that last.

## What's Reasonable?

**Environmental Wear and Tear:** Our products are engineered using quality materials that are specific to the end-use. Normal wear and tear and the breakdown of materials due to age, use, or environmental conditions are not covered under our guarantee.

**Accidental Damage:** Damage due to improper use or care, accident, or negligence is not covered under our guarantee. However, we always aim to exceed expectations, so we'll look to assist with a functional repair whenever possible.

**Limited Duration:** Due to their very nature, some of our products are intended for use in situations which result in higher rates of wear and tear, which is why they have a limited warranty duration. This is clearly marked on the packaging and on our website, so customers know where they stand, and what to expect.



# WORKBOOK GUIDE

We want to make navigating this workbook as easy as possible. Here's how to make the most of our workbook.

## TABLE OF CONTENTS PAGE

The **CLICKABLE TEXT** on this page will bring you to that category, sub-category or overview as listed.

TENTS, TARPS + SHELTERS		CAMP KITCHEN		STRAPS + TRANSPORT ACCESSORIES	
Tents <b>NEW</b>	13	Camp Clean Up	182	Attachment Accessories	295
Tarps + Shelters	25	Dinnerware	188	Straps	297
Accessories	28	Cookware	209	Field Repair Accessories	303
		Water Transport	223	Roof Accessories	306
STORAGE		TRAVEL + COMMUTE		WATERSPORTS	
Dry Storage <b>NEW</b> <b>UPDATED</b>	41	Every Day Carry <b>UPDATED</b>	230	Storage + Transport	311
Compression Dry Bags	56	Bags + Luggage	238	Paddle Accessories	317
Dry Organisation + Accessory Cases	66	Organisation <b>UPDATED</b>	241		
Stuff + Compression Sacks <b>UPDATED</b>	71				
SLEEP		CARE + PROTECTION			
Sleeping Bags	84	Towels	254		
Down	86	Personal Care	259		
Synthetic	107	Utility + Convenience	267		
Quilts + Comforters	116	Gaiters	273		
Sleeping Bag Liners	128	Insect Protection	280		
Sleeping Mats	136	Clothing	281		
Air Sprung Cells	148	Shelters	284		
Self Inflating	158	Pack + Rain Protection	288		
Pillows	164				
Hammocks	174				

## NAVIGATION ICONS

Use these icons to navigate and shortcut through the workbook.

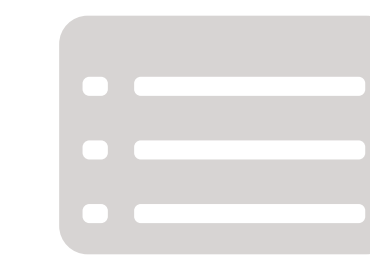

The **MENU**, located at the top of most pages will always take you back to the table of contents.



The **EYE ICON**, located at the top of most pages will always take you back to the overview page for that range.

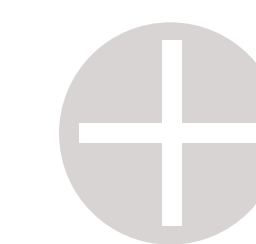

The **PLUS SIGN** icon will take you to expanded information about that product.



The **RETURN ARROW ICON** will take you to back to the associated product page.



If a product has a **VIDEO ICON** it will take you to a web based product page.

## TENTS, TARPS + SHELTERS

Tents <b>NEW</b>	13
Tarps + Shelters	25
Accessories	28

## STORAGE

Dry Storage <b>NEW</b> <b>UPDATED</b>	38
Dry Bags	41
Compression Dry Bags	56
Dry Organisation + Accessory Cases	66
Stuff + Compression Sacks <b>UPDATED</b>	71

## SLEEP

Sleeping Bags	84
Down	86
Synthetic	107
Quilts + Comforters	116
Sleeping Bag Liners	128
Sleeping Mats	136
Air Sprung Cells	151
Self Inflating	158
Pillows	164
Hammocks	174

## CAMP KITCHEN

Camp Clean Up	182
Dinnerware	188
Cookware	209
Water Transport	223

## TRAVEL + COMMUTE

Every Day Carry <b>UPDATED</b>	230
Bags + Luggage	238
Organisation <b>UPDATED</b>	241

## CARE + PROTECTION

Towels	254
Personal Care	259
Utility + Convenience	267
Gaiters	273
Insect Protection	280
Clothing	281
Shelters	284
Pack + Rain Protection	288

## STRAPS + TRANSPORT ACCESSORIES

Attachment Accessories	295
Straps	297
Field Repair Accessories	303
Roof Accessories	306

## WATERSPORTS

Storage + Transport	311
Paddle Accessories	317

# TENTS, TARPS + SHELTERS





# TENTS, TARPS + SHELTERS

WHERE HIGH QUALITY MATERIALS, CLEVER FUNCTIONAL TOUCHES AND UNIQUE LIVABILITY MEET

## CLASS LEADING DESIGN + ENGINEERING

Our tents, tarps and shelters are characterised by innovation. We innovated ours to provide more living space, higher doors and far better ventilation amongst many more features.

## UNMATCHED VERSATILITY

Roll up the rainfly in Stargazer mode on a moonlit night. Or tilt the Telos or Ikos rainfly into Hangout Mode, forming a semi-enclosed shelter for you and your mates.

## USER-FOCUSED DESIGN

These are not 'features', or designer gimmicks. They are design elements that make our shelters easier to live with.



TENTS

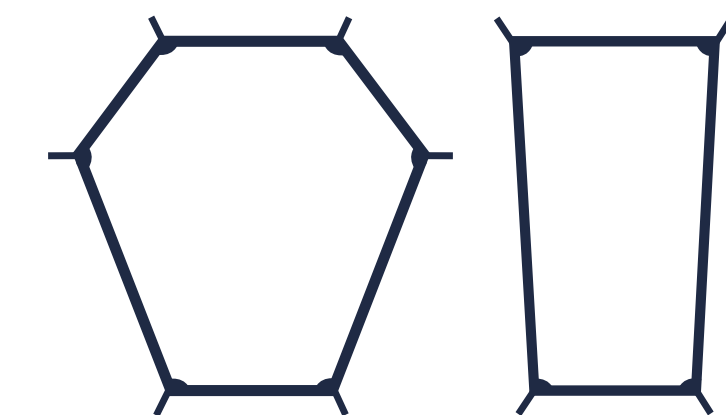

TENT, TARP + SHELTER ACCESSORIES

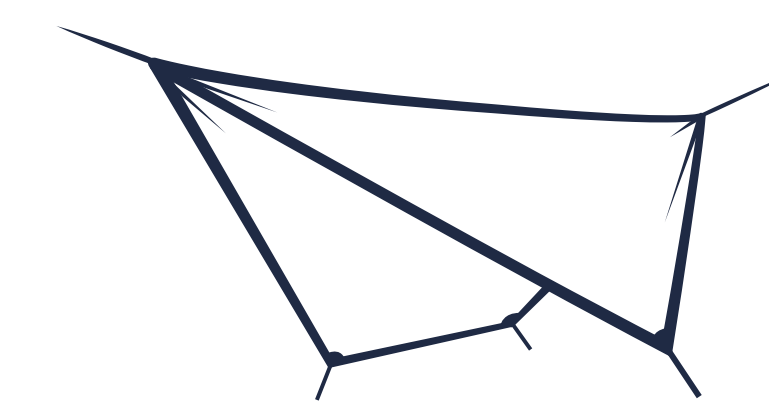

TARPS + SHELTERS



# ALTO + TELOS TENTS

Award-winning, ultralight backpacking tents with more space, superior ventilation and unmatched versatility.

ALTO TR



TELOS TR

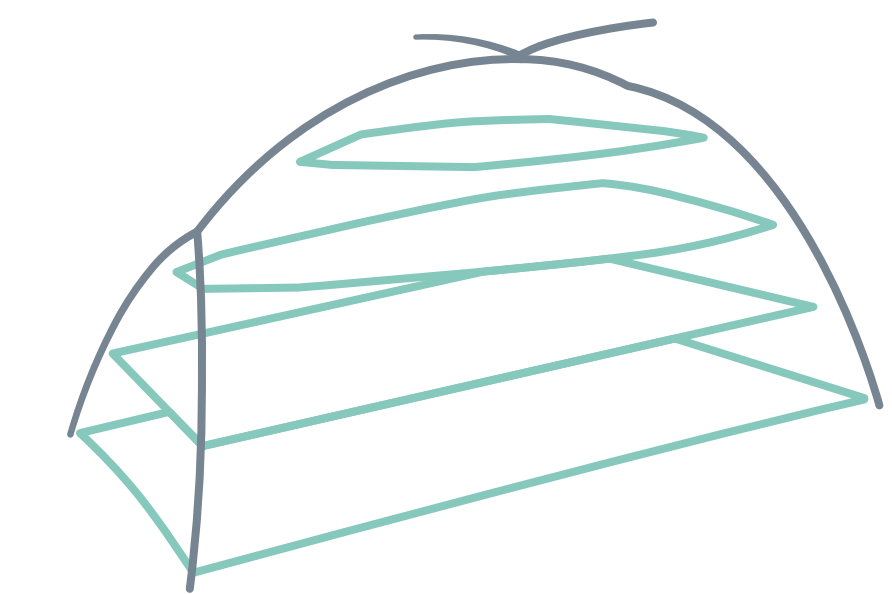

## MORE SPACE

Tension Ridge architecture delivers a better space-to-weight ratio than any tent in its class.

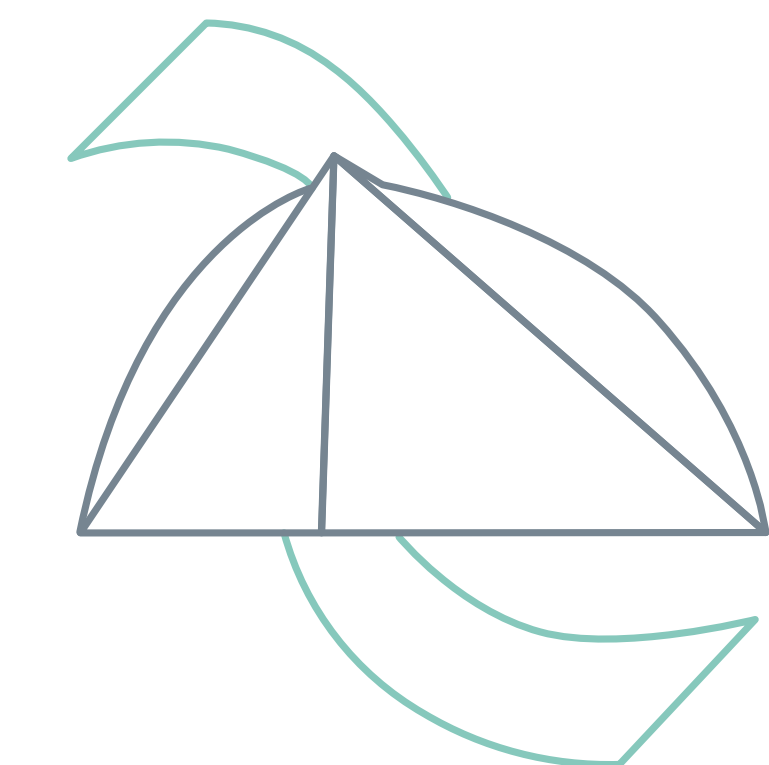

## SUPERIOR VENTILATION

An advanced venting system improves airflow and reduces condensation.

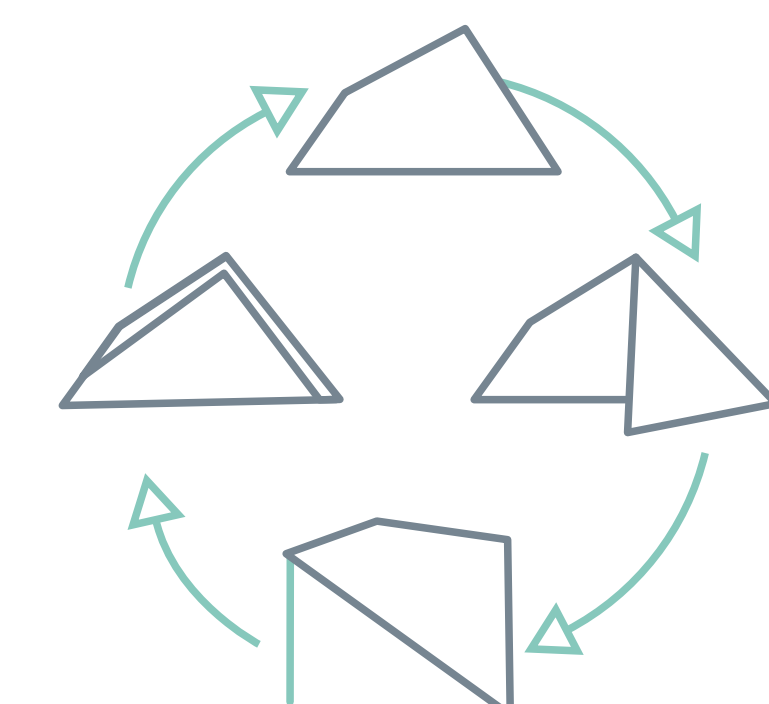

## UNMATCHED VERSATILITY

Multiple configuration options means our tents adapt to the weather or your activity.

TENSION RIDGE  
ARCHITECTURE BY JAKE LAH



## REVOLUTIONARY TENSION RIDGE ARCHITECTURE

Where most tent poles angle down, the Tension Ridge angles up to achieve exceptional height and space.

# TENSION RIDGE

ARCHITECTURE BY JAKE LAH

### HIGH CEILINGS

Tall campers rejoice! Tension Ridge creates greater height across the whole tent—not just in one spot.

### VERTICAL WALLS

No aggressively tapered walls here—just plenty of room for thicker modern sleeping mats.

### APEX VENT

Unlike most, our Apex vent is at the highest point of our tents—the perfect position to expel moist warm air and minimise condensation.

### TALL DOORS

Get in and out of your tent with ease and enjoy expansive views outside.





**+**  
OUR TENSION RIDGE  
TENTS FEATURE:



**HANGOUT MODE**

Convert your tent's fly into a semi-open shelter—perfect for group meals, socialising and staying undercover. Featured in all our Telos and Ikos models, simply set-up with trekking poles or the Hangout Mode Pole Set (available separately).

**QUICK-CONNECT TENT FEET**

Machined aluminium clip attaches and tensions the fly with one-handed ease—much stronger than breakable plastic buckles.



**STORAGE SYSTEM**

Alto and Telos tents pack into three Fairshare stuff sacks to split the load—after set-up, stuff sacks transform into gear storage pockets. The Telos Bikepack tent features robust, waterproof dry bags with air-permeable eVent® bases. The new Ikos tent comes in a lateral compression storage sack for saving space in your pack, boat or vehicle.

**COLOUR-CODED DAC POLES**

The gold standard in tent poles—our Alto and Telos tents combine DAC Featherlite NFL, NSL and PRESSFIT sections. The Ikos tents feature DAC MX poles



**GROUND CONTROL  
LIGHT TENT PEG**

Lightweight, strong and versatile—our unique TriPoint tent pegs maximise grip in almost any ground.

**LIGHTBAR**

Add a headlamp and secure your Alto or Telos tent pole storage sack to the apex of the tent for soft, even illumination.

**MULTIPLE SET-UP MODES**

Our tents easily adapt to suit your adventure, weather conditions and weight requirements.



CLASSIC MODE



FLY ONLY MODE



INNER ONLY MODE



DRY SET-UP



PARTIAL FLY MODE

# EXPLORE THE RANGE

## ALTO TR

Semi-freestanding ultralight backpacking tents.



ALTO TR1



ALTO TR1 PLUS



ALTO TR2



ALTO TR2 PLUS

ONE PERSON

TWO PERSON

## TELOS TR

Award-winning freestanding ultralight backpacking tents.



TELOS TR2



TELOS TR2 PLUS



TELOS TR2 BIKEPACK



TELOS TR3



TELOS TR3 PLUS

TWO PERSON

THREE PERSON

## IKOS TR NEW

Great liveability, space and versatile setup options for everyday backpacking and vehicle-supported camping.



IKOS TR2



IKOS TR3

TWO PERSON

THREE PERSON





# ALTO TR

# TELOS TR

# IKOS TR

	ONE PERSON		TWO PERSON		TWO PERSON			THREE PERSON		TWO PERSON	THREE PERSON
	ALTO TR1	ALTO TR1 PLUS	ALTO TR2	ALTO TR2 PLUS	TELOS TR2	TELOS TR2 BIKEPACK	TELOS TR2 PLUS	TELOS TR3	TELOS TR3 PLUS	IKOS TR2	IKOS TR3
INNER CONSTRUCTION	MESH	FABRIC	MESH	FABRIC	MESH	MESH	FABRIC	MESH	FABRIC	MESH	MESH
SEASONS	3 Season	3+ Season	3 Season	3+ Season	3 Season	3 Season	3+ Season	3 Season	3+ Season	3 Season	3 Season
DOORS	1	1	2	2	2	2	2	2	2	2	2
VESTIBULES	1	1	2	2	2	2	2	2	2	2	2
ARCHITECTURE	Semi-Freestanding		Semi-Freestanding		Freestanding			Freestanding		Freestanding	Freestanding
TENSION RIDGE (TR)	●	●	●	●	●	●	●	●	●	●	●
APEX VENT	●	●	●	●	●	●	●	●	●	●	●
LIGHTBAR	●	●	●	●	●	●	●	●	●	●	●
HANGOUT MODE	-	-	-	-	●	●	●	●	●	●	●
MINIMUM TRAIL WEIGHT <small>Fly + inner + poles only</small>	938g	1056g	1156g	1247g	1482g	1507g	1531g	1921g	2127g	2154g	2940g
PACKED WEIGHT <small>Above + pegs, stuff sack, guys</small>	1110g	1228g	1340g	1458g	1657g	1914g	1706g	2118g	2229g	2371g	3168g
FLOOR DIMENSIONS <small>(head-foot W) x L</small>	(107-60) x 215cm		(134-97) x 215cm		(134-109) x 215cm			(181-147) x 230cm		135 x 215cm	200 x 230cm
DOOR HEIGHT	108cm		108cm		110cm			133cm		105cm	123cm
RIDGE HEIGHT	100cm		100cm		100cm			123cm		100cm	120cm
PEAK HEIGHT	105cm		105cm		105cm			128cm		105cm	123cm
FLOOR AREA	1.8m <sup>2</sup>		2.5m <sup>2</sup>		2.62m <sup>2</sup>			3.69m <sup>2</sup>		2.9m <sup>2</sup>	4.6m <sup>2</sup>
VESTIBULE AREA	0.7m <sup>2</sup>		1.7m <sup>2</sup>		1.8m <sup>2</sup>			2m <sup>2</sup>		1.65m <sup>2</sup>	2.26m <sup>2</sup>
MAT COMPATIBILITY <small>Sea to Summit</small>	1 Large Tapered		1 Large + 1 Regular Tapered		2 Large Tapered			2 Large Rectangular OR 3 Regular Tapered OR 2 Regular + 1 Large Tapered (inverted)		2 Large Rectangular	3 Large Rectangular
FLY FABRIC	15D Sil-PeU	15D Sil-PeU	15D Sil-PeU	15D Sil-PeU	15D Sil-PeU	15D Sil-PeU	15D Sil-PeU	15D Sil-PeU	15D Sil-PeU	68D PeU Polyester	68D PeU Polyester
FLY WATERHEAD	1200mm	1200mm	1200mm	1200mm	1200mm	1200mm	1200mm	1200mm	1200mm	1800mm	1800mm
FLOOR FABRIC	15D Sil-PeU	20D Sil-PeU	15D Sil-PeU	20D Sil-PeU	20D Sil-PeU	20D Sil-PeU	30D Sil-PeU	20D Sil-PeU	30D Sil-PeU	68D PeU Polyester	68D PeU Polyester
FLOOR WATERHEAD	1200mm	2500mm	1200mm	2500mm	2500mm	2500mm	4000mm	2500mm	4000mm	4000mm	4000mm
COLOUR											



# ALTO TR

TR1 TR1 PLUS TR2 TR2 PLUS

Our semi-freestanding Alto tents are our lightest and most compact models—perfect for weight-conscious backpackers.

Available in one-person and two-person configurations.



\*Alto TR2 pictured



Fairshare storage system allows you to split the load between your fellow campers.



ALTO TR1 TR2

Ultra-lightweight 15D polyester high-airflow mesh inner for maximum ventilation and no-see-um insect protection. 15D Sil-Peu coated seam-taped 1500mm waterhead floor.



ALTO TR1 PLUS TR2 PLUS

Breathable 20D Nylon fabric canopy with a 20D Sil-PeU coated, seam-taped 2500mm waterhead floor for dependable performance in cold and wet conditions.

## ALTO TR1 TR1 PLUS

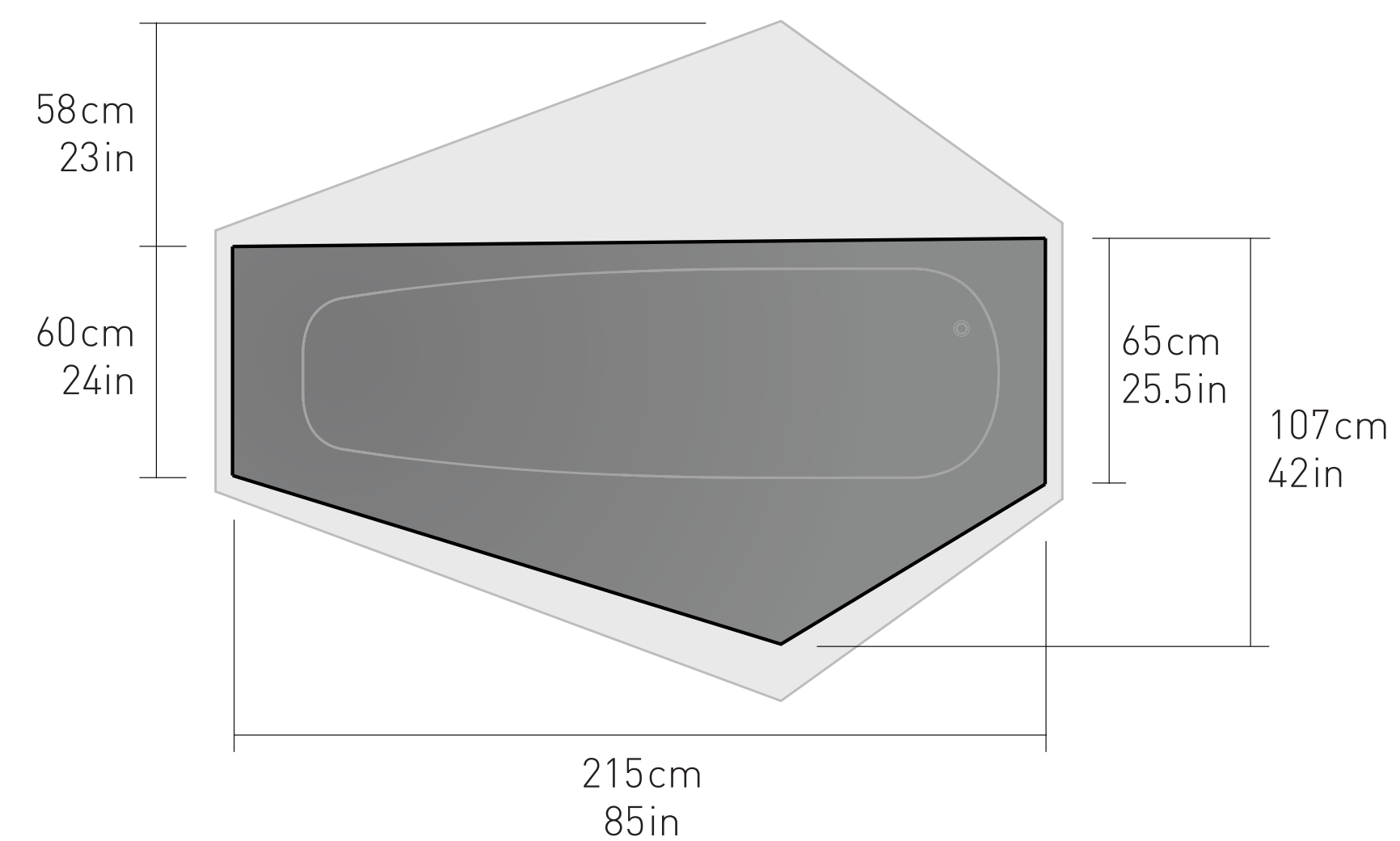
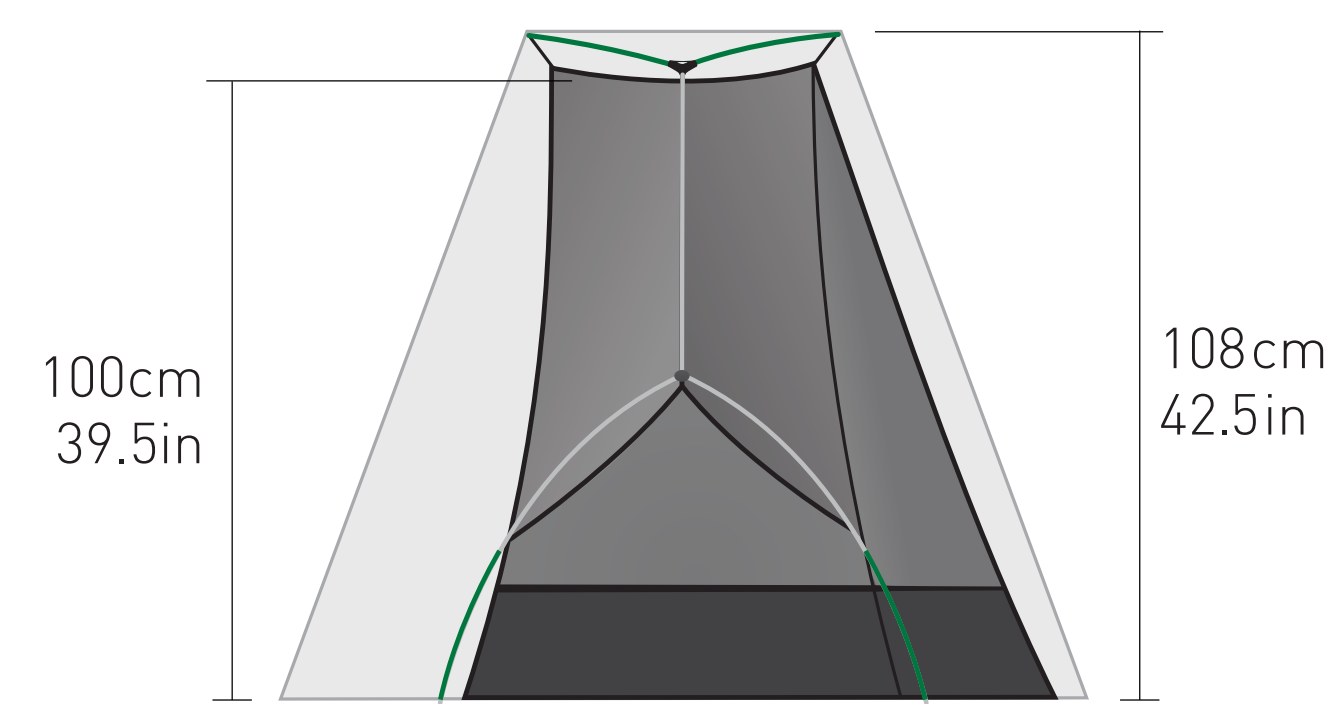

## ALTO TR2 TR2 PLUS

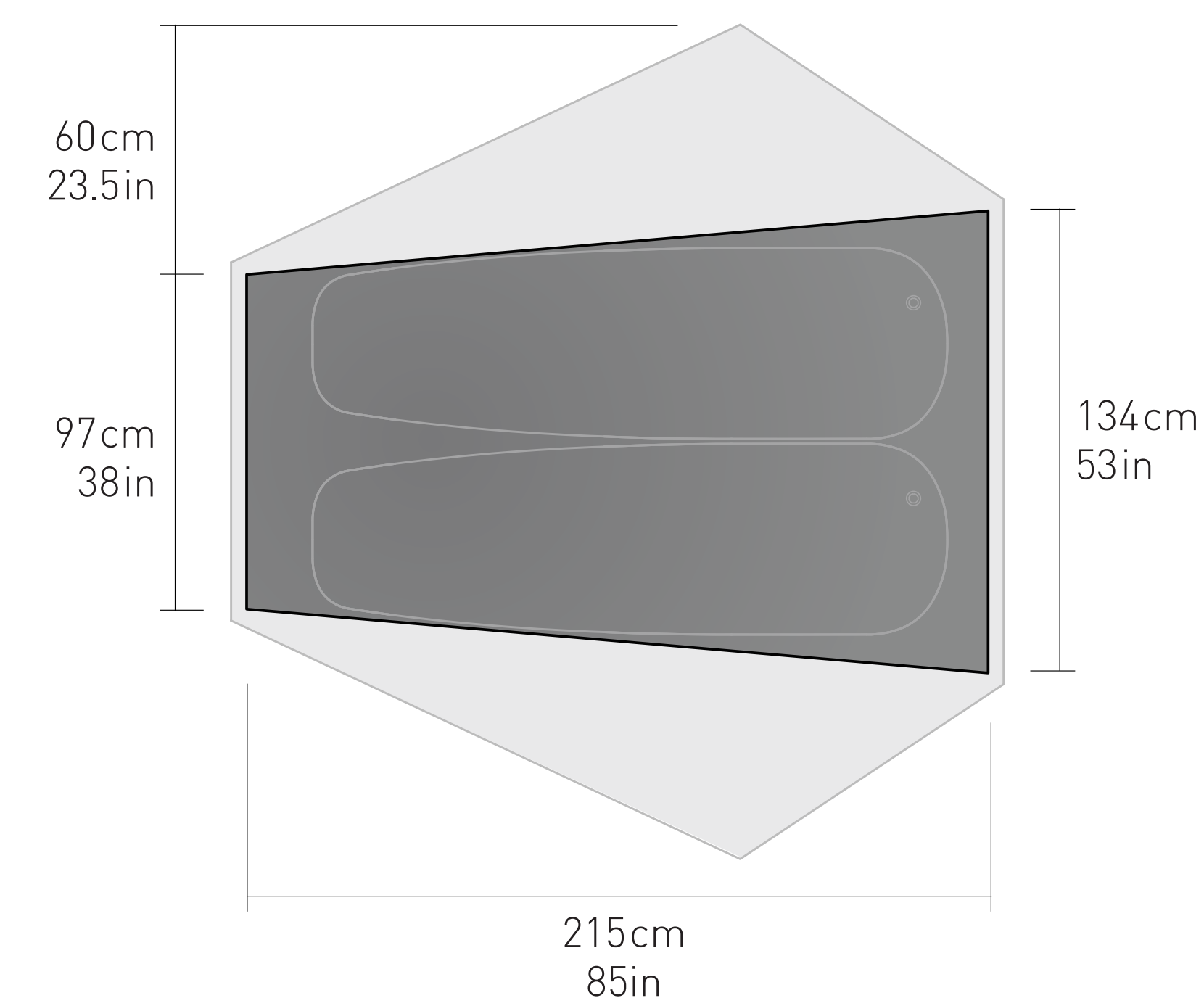
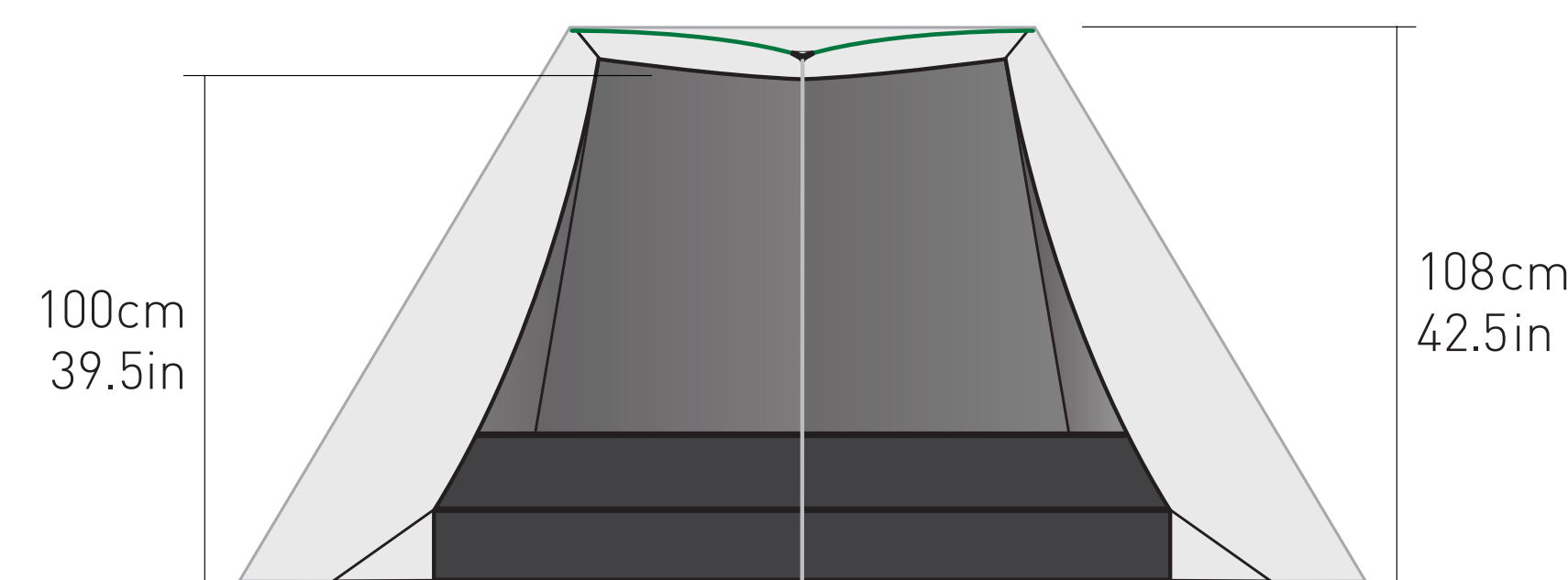



### ALTO TR1

PRODUCT	CODE	INNER CONSTRUCTION	POLE TYPE	PACKED DIMENSIONS	MIN TRAIL WEIGHT	PACKED WEIGHT	COLOUR	RRP
ALTO TR1	ATS2039-01160410	Mesh / Fabric	DAC Featherlite NFL 8.7mm&NSL 9.0mm Anodised Aluminium Alloy	Ø11 x 44cm	938g	1110g		
ALTO TR1 PLUS	ATS2039-02160402	Fabric / Fabric	DAC Featherlite NFL 8.7mm&NSL 9.0mm Anodised Aluminium Alloy	Ø11 x 44cm	1056g	1228g		

### ALTO TR2

PRODUCT	CODE	INNER CONSTRUCTION	POLE TYPE	PACKED DIMENSIONS	MIN TRAIL WEIGHT	PACKED WEIGHT	COLOUR	RRP
ALTO TR2	ATS2039-01170409	Mesh / Fabric	DAC Featherlite NFL 8.7mm&NSL 9.0mm Anodised Aluminium Alloy	Ø12 x 52cm	1156g	1340g		
ALTO TR2 PLUS	ATS2039-02170406	Fabric / Fabric	DAC Featherlite NFL 8.7mm&NSL 9.0mm Anodised Aluminium Alloy	Ø12 x 52cm	1247g	1458g		



# TELOS TR

TR2 TR2 PLUS TR3 TR3 PLUS

Featuring Hangout Mode, our award-winning freestanding Telos tents deliver the ultimate ultralight camp experience.

Available in two-person and three-person configurations.



FEATURES  
HANGOUT MODE



TELOS TR2 TR3

Ultra-lightweight 15D polyester high-airflow mesh inner for maximum ventilation and no-see-um insect protection. 20D Sil-PeU coated seam-taped 2500mm waterhead floor.



TELOS TR2 PLUS TR3 PLUS

Breathable 20D Nylon fabric canopy with a 30D Sil-PeU coated, seam-taped 8000mm waterhead floor for dependable performance in cold and wet conditions.

## TELOS TR2 TR2 PLUS

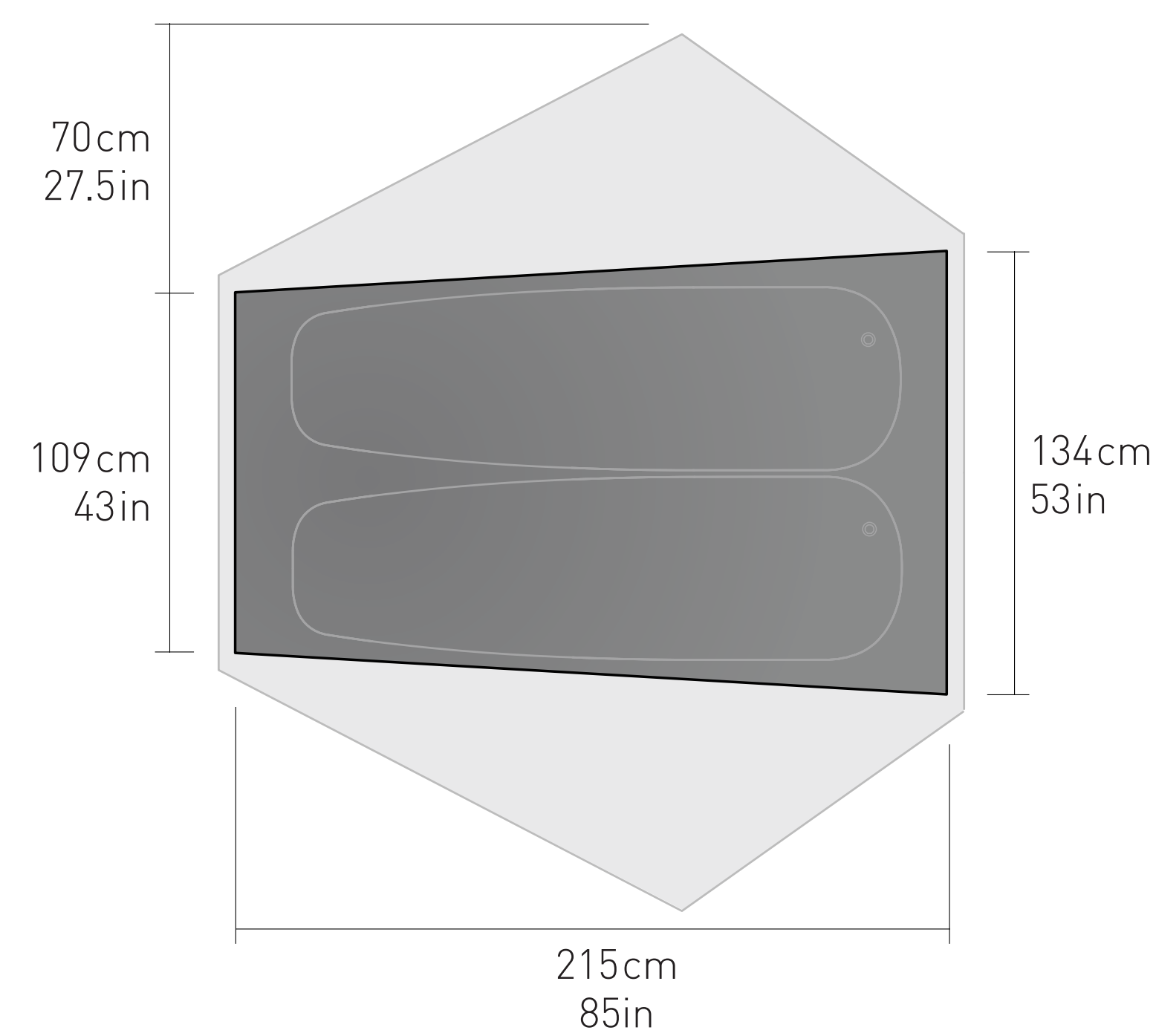
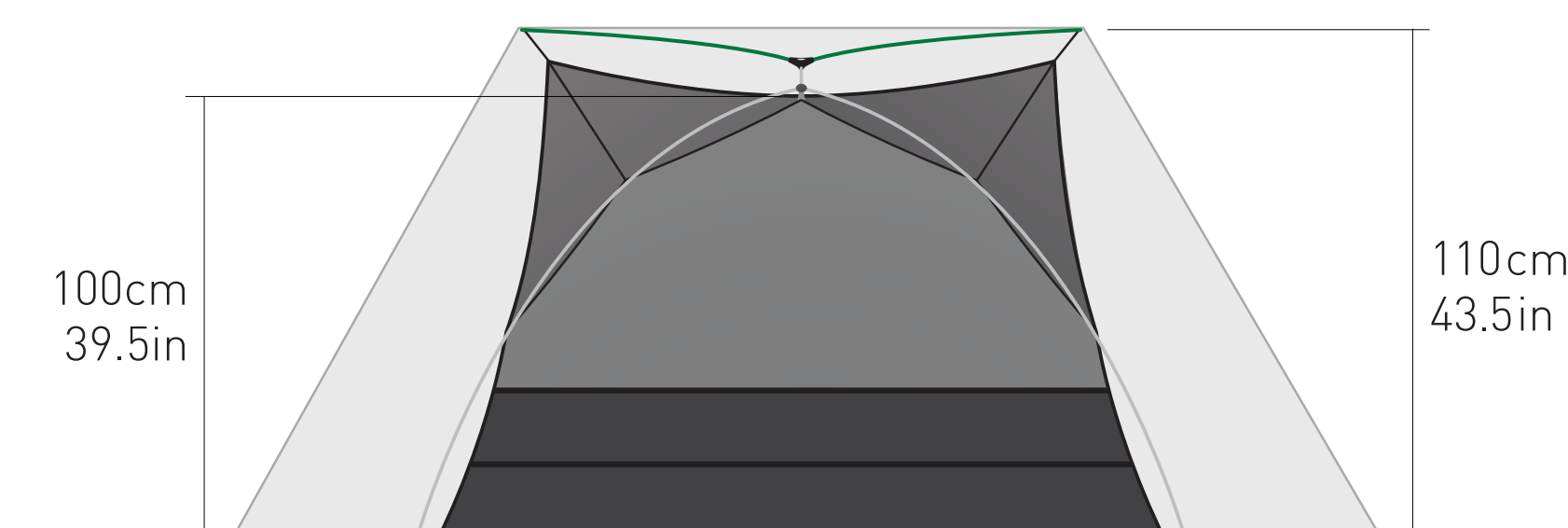

## TELOS TR3 TR3 PLUS

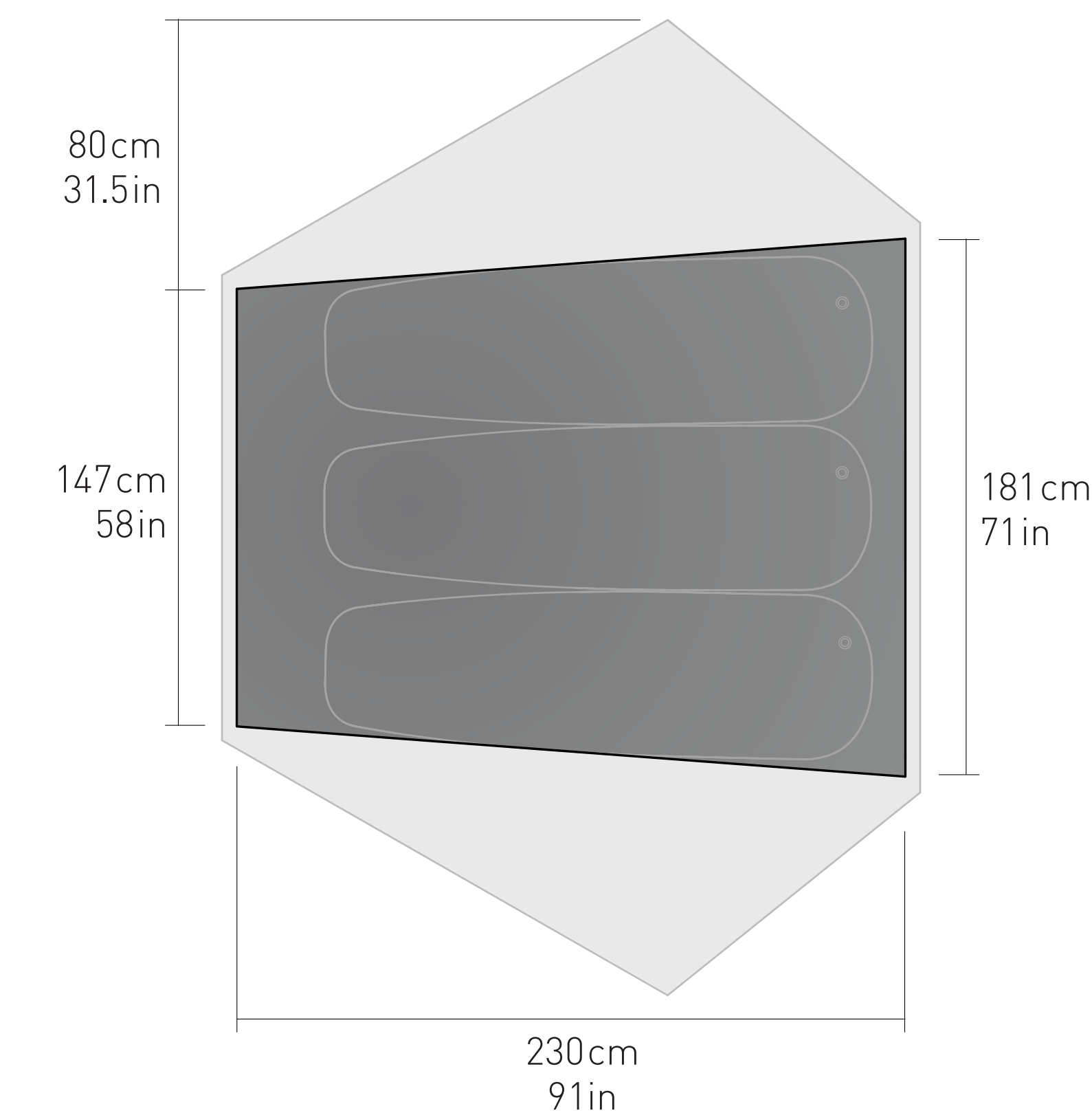
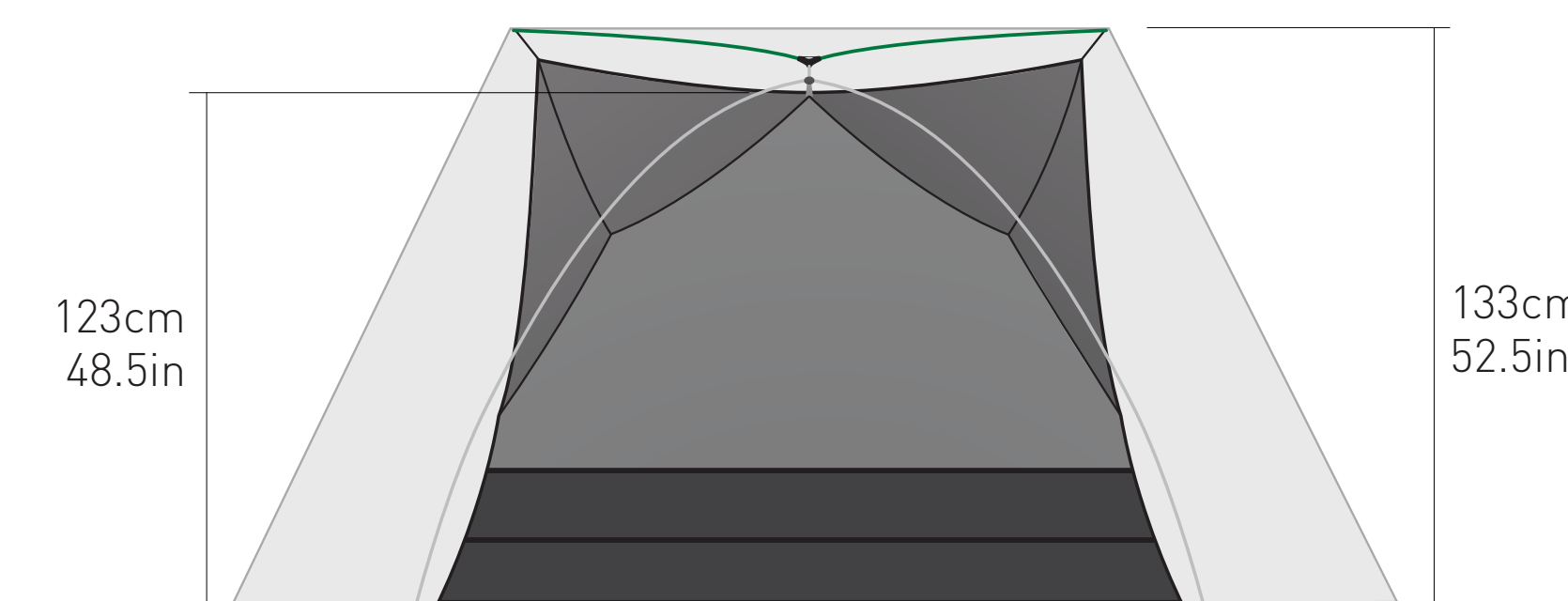



# TELOS TR2 BIKEPACK

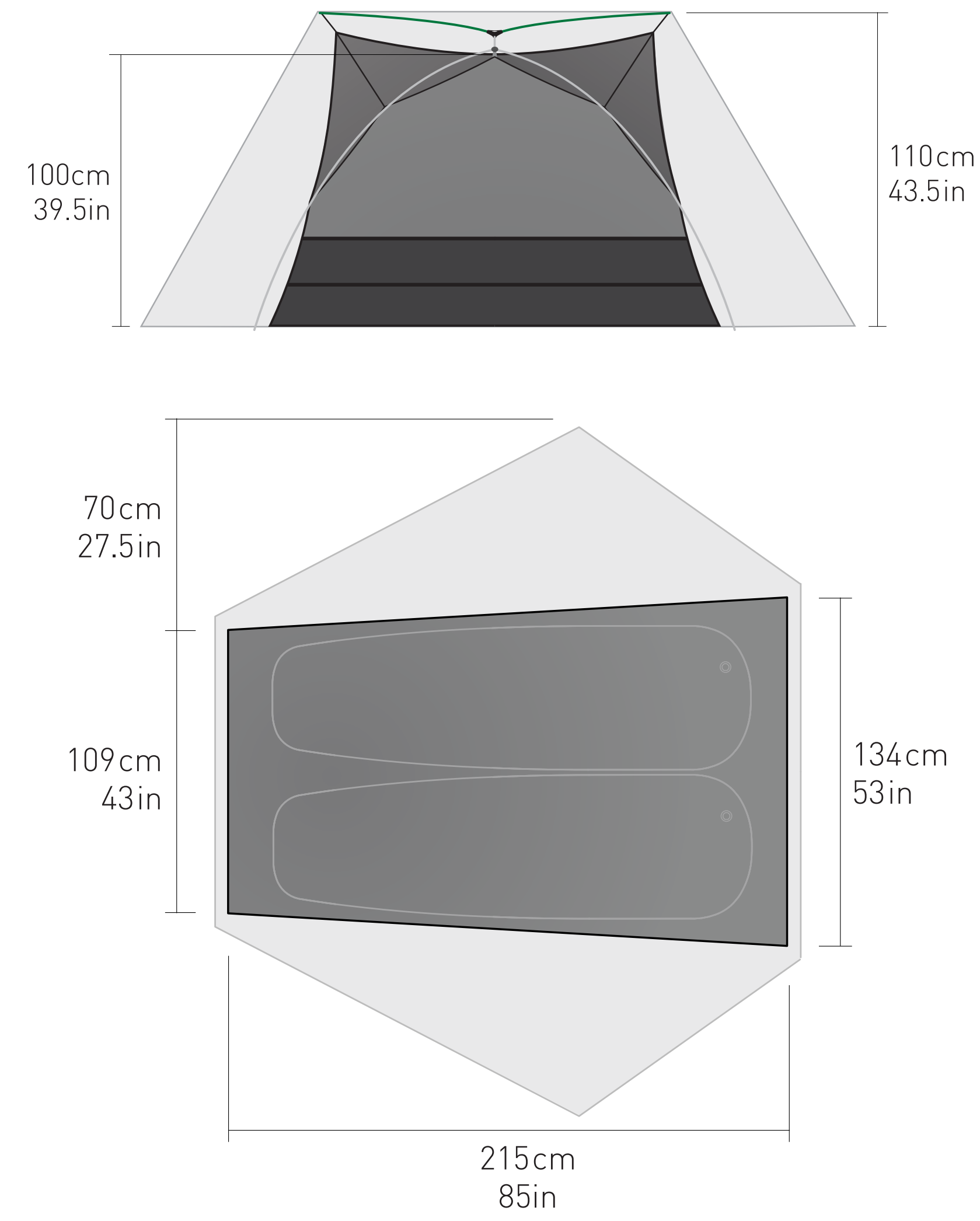

Ultra-lightweight 15D polyester high-airflow mesh inner for maximum ventilation and no-see-um insect protection.



Our modular storage system allows you to split the load between your fellow campers, or pack each component separately for even weight distribution and to suit space limitation of your bike.



Shorter pole sections to better suit bikepacking needs.

## FEATURES HANGOUT MODE





### TELOS TR2

PRODUCT	CODE	INNER CONSTRUCTION	POLE TYPE	PACKED DIMENSIONS	MIN TRAIL WEIGHT	PACKED WEIGHT	COLOUR	RRP
TELOS TR2	ATS2040-01170409	Mesh / Fabric	DAC Featherlite NSL 8.5mm & 9.0mm Anodised Aluminium Alloy	Ø13 x 48cm	1482g	1657g		
TELOS TR2 PLUS	ATS2040-01170402	Fabric / Fabric	DAC Featherlite NSL 8.5mm & 9.0mm Anodised Aluminium Alloy	Ø13 x 48cm	1531g	1706g		
TELOS TR2 BIKEPACK	ATS042051-170401	Mesh / Fabric	DAC Featherlite NSL 8.5mm & 9.0mm Anodised Aluminium Alloy	15 x 22 x 30cm	1507g	1914g		

### TELOS TR3

PRODUCT	CODE	INNER CONSTRUCTION	POLE TYPE	PACKED DIMENSIONS	MIN TRAIL WEIGHT	PACKED WEIGHT	COLOUR	RRP
TELOS TR3	ATS2040-01180411	Mesh / Fabric	Featherlite NSL 9.6mm & PF 9.5mm Anodised Aluminium Alloy	Ø15 x 49cm	1921g	2118g		
TELOS TR3 PLUS	ATS2040-02180406	Fabric / Fabric	Featherlite NSL 9.6mm & PF 9.5mm Anodised Aluminium Alloy	Ø15 x 49cm	2127g	2229g		



# IKOS TR **NEW**

TR2 TR3

Building on the design advances made in our award-winning ultralight Telos Tension Ridge tents, Sea to Summit introduces the Ikos Tent which offers the same great liveability, space and versatile setup options for everyday backpacking and vehicle-supported camping.

Available in two-person and three-person configurations—each including gear lofts.



\*IKOS TR2 pictured

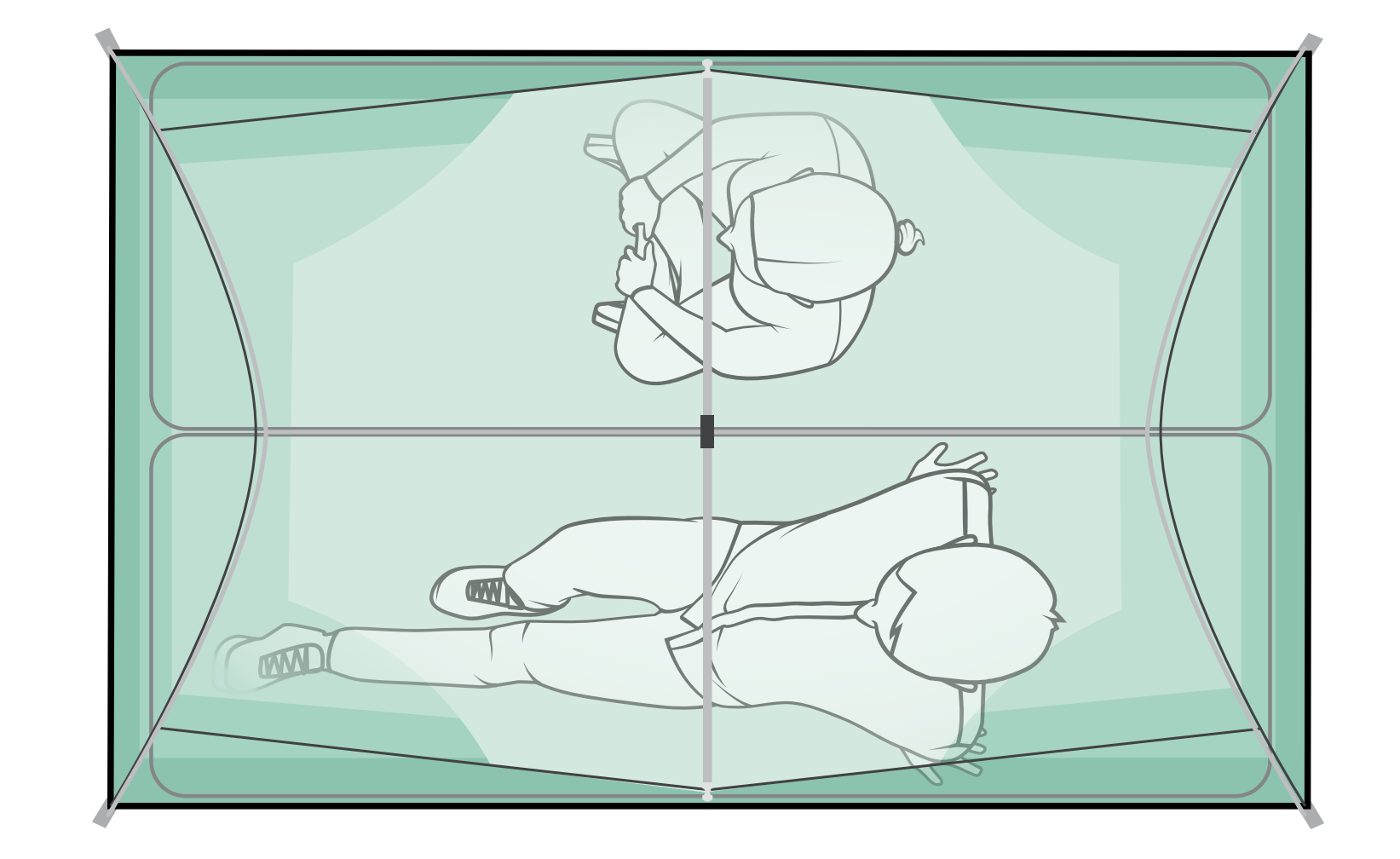

Roomy and spacious with enough space to get changed and move around even with two people side-by-side.



## IKOS TR2

Ultra-lightweight 20D Polyester mesh inner for maximum ventilation and no-see-um insect protection.



## IKOS TR3

Our 68D polyester ripstop fly fabric is coated with durable Polyether Polyurethane (PeU) to allow fully taped waterproof seams and boasts a waterhead of 1800mm. PeU chemistry has excellent hydrolytic stability for long term durability.

## IKOS TR2

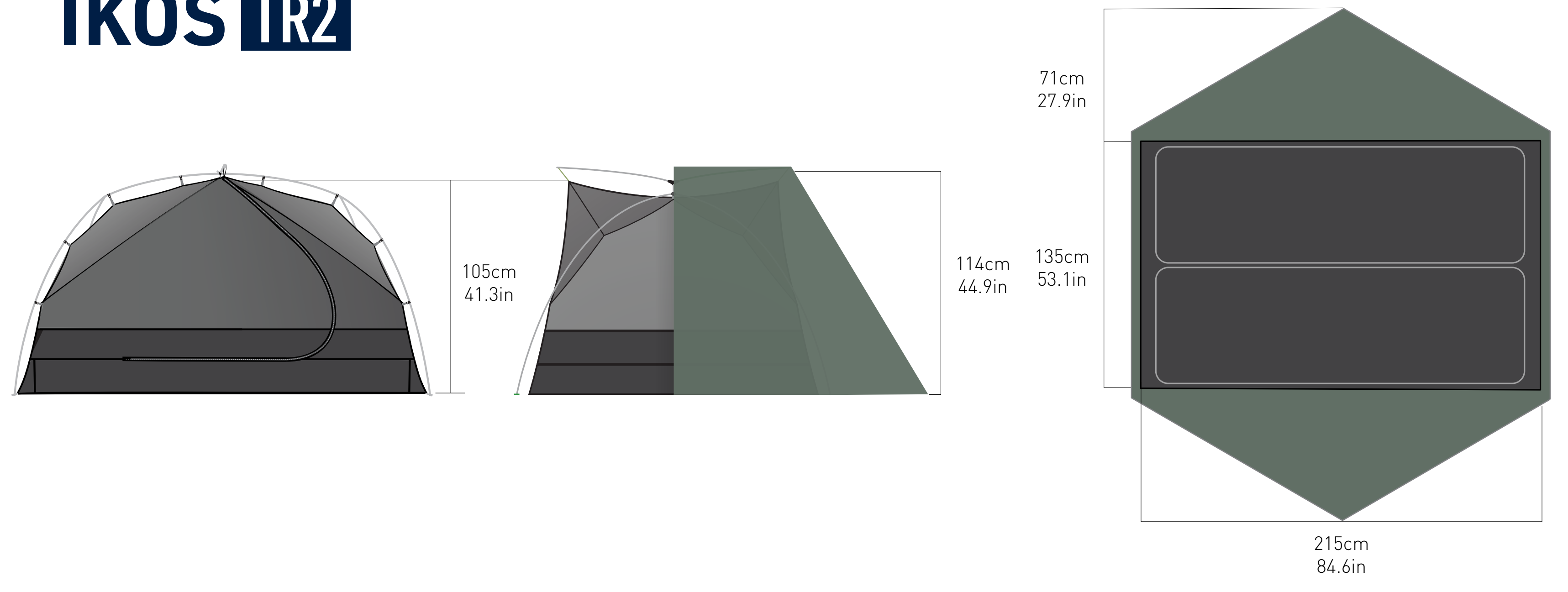

## IKOS TR3

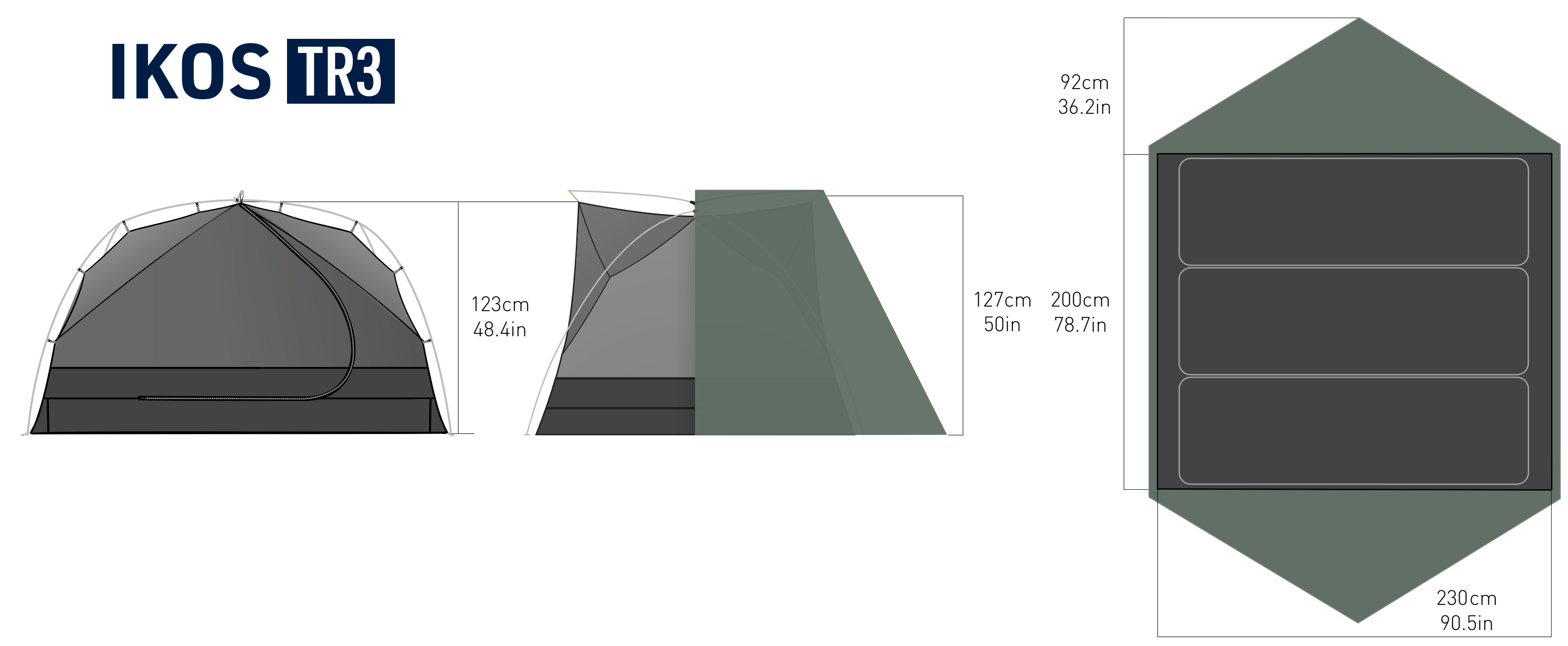

**SUSTAINABLE DESIGN**  
CO Non-PFC Water Repellent Finish



### IKOS TR2 TR3

PRODUCT	CODE	INNER CONSTRUCTION	POLE TYPE	PACKED DIMENSIONS	MIN TRAIL WEIGHT	PACKED WEIGHT	COLOUR	RRP
IKOS TR2	ATS043281-172001	Mesh / Fabric	DAC MX poles 9.6mm Anodised Aluminium Alloy	Ø17.5 x 50cm	2154g	2371g		
IKOS TR3	ATS043281-182002	Mesh / Fabric	DAC MX poles 10.8mm Anodised Aluminium Alloy	Ø20 x 50cm	2940g	3168g		



# TARPS + SHELTERS

Technical, versatile and ultra-lightweight  
—loved by gram counters.





### ESCAPIST 15D TARP

Protects two sleepers from the rain when set up close to the ground as an A-Frame—doubles as a tent awning, sun shelter or kitchen area.

#### FEATURES

- Reinforced corners with cord lock and reflective guy lines (which can be adjusted from under the tarp)
- To make a tarp shelter place a trekking pole through the circular bar-tack

SIZES M / L

**15D ULTRA-SIL**



### ESCAPIST ULTRA-MESH INNER TENT

Persistent insects meet their match—and you'll barely know it's in your pack.

#### FEATURES

- Siliconised Nylon tape-seamed tub floor with generous splash skirt and curved zip entrance
- Strong and durable black fine mesh upper for better visibility



**310 HOLES per cm**



## TARPS + SHELTERS

PRODUCT NAME	CODE	SIZE	DIMENSIONS	COLLAPSED DIMENSIONS	WEIGHT	MATERIALS	RRP
 Escapist 15D Tarp	AESCTARPM	Medium	260 x 200cm	ø8.5 x 19cm	300g	15D Si/PU coated Nylon, 1,200mm waterhead	
	AESCTARPL	Large	300 x 300cm	ø9 x 23cm	440g		
 Escapist Ultra-Mesh Inner Tent	AESCUMBUGTENT		220 x 120 x 100cm	ø10 x 23cm	385g	15D Si/PU coated Nylon, 1,200mm waterhead, 15D Nylon Mesh	

# TENTS, TARPS + SHELTER ACCESSORIES

From ultralight footprints to space-optimising Gear Lofts—complete your tent set-up with customised accessories.



# EXPLORE THE RANGE

## TENT ACCESSORIES



FOOTPRINTS



GROUND SHEETS



HANGOUT MODE  
POLESET



GEAR LOFTS



GUY LINES



TENT PEGS



## TENT FOOTPRINTS

The minimalist Lightfoot covers the outline of your tent tub floor while the full coverage Bigfoot extends to include vestibules.

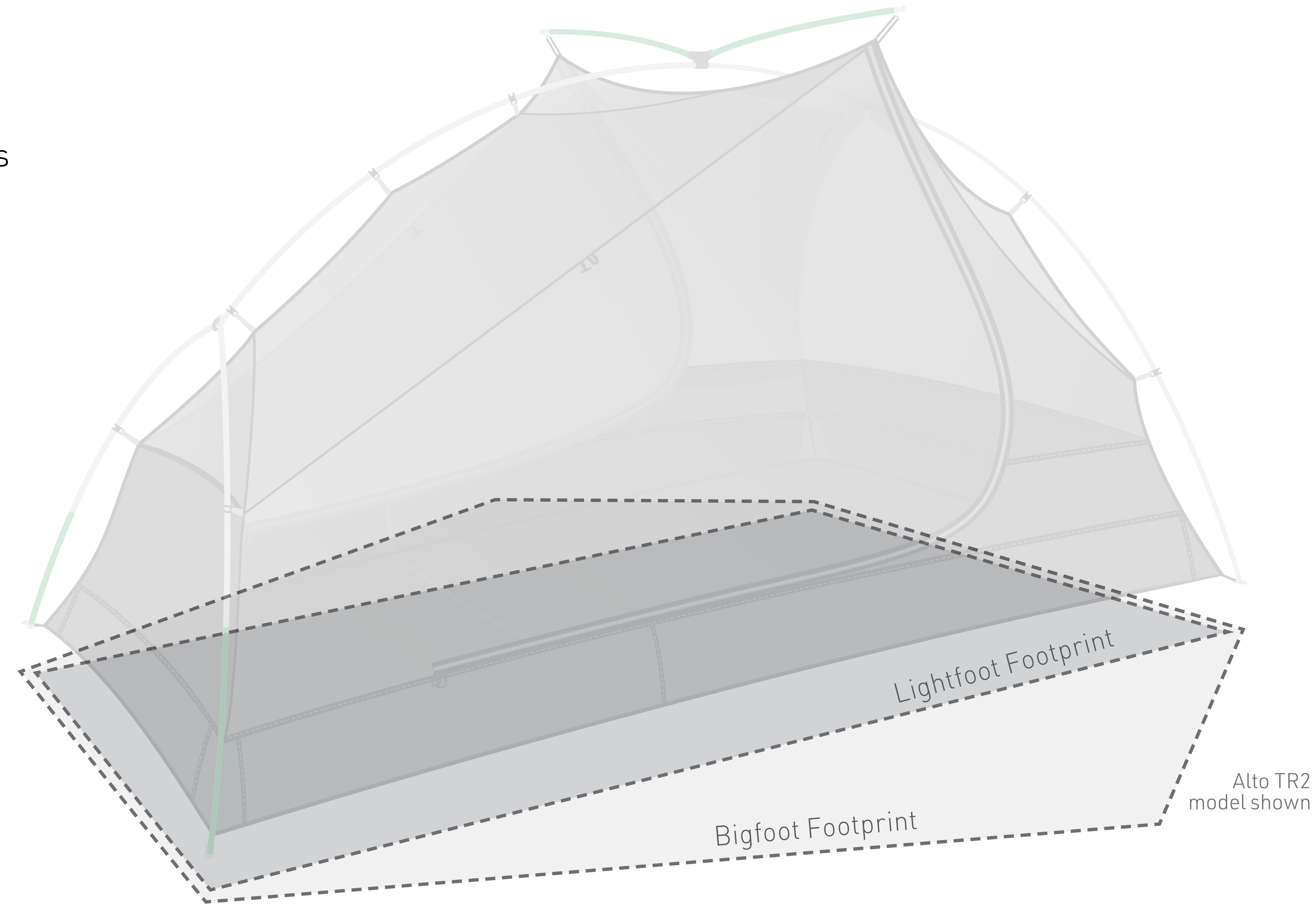

Protect your tent floor from abrasion tears and dirt with our durable and lightweight footprints.



Perfect fit for an easy Fly Only tent set-up



Comes with a lightweight storage pouch

Alto TR1

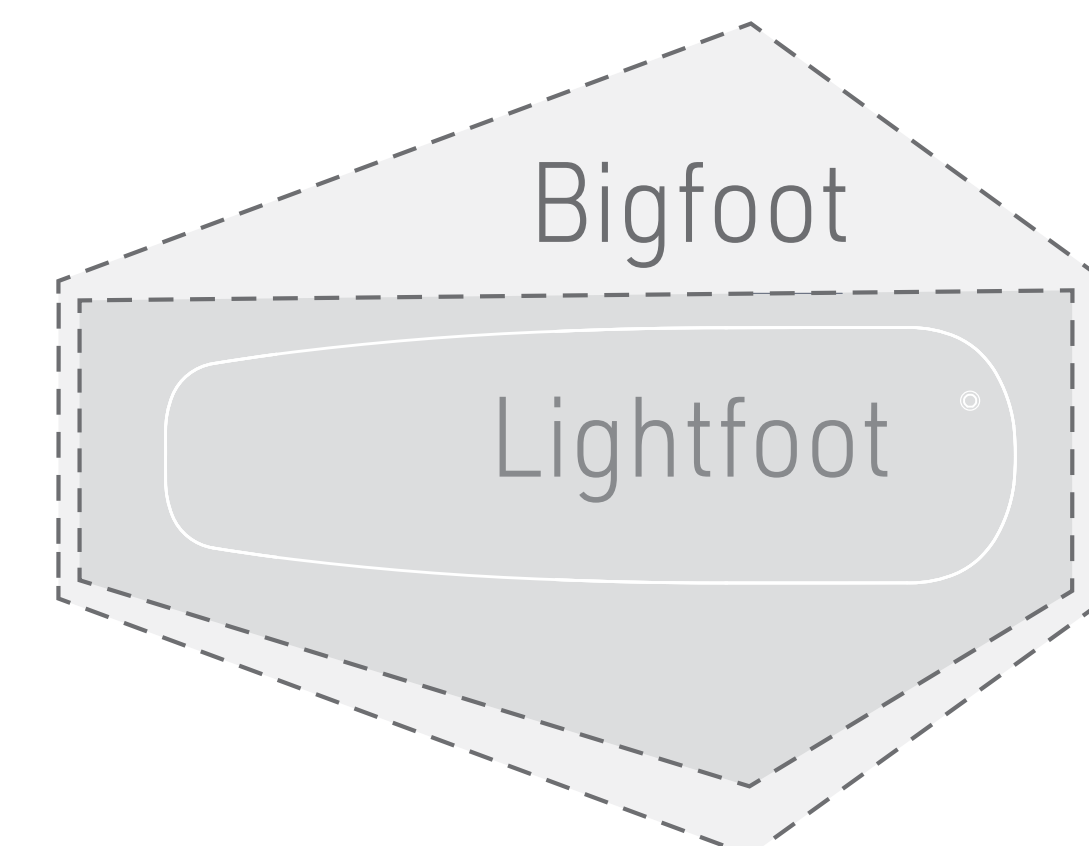

Alto TR2

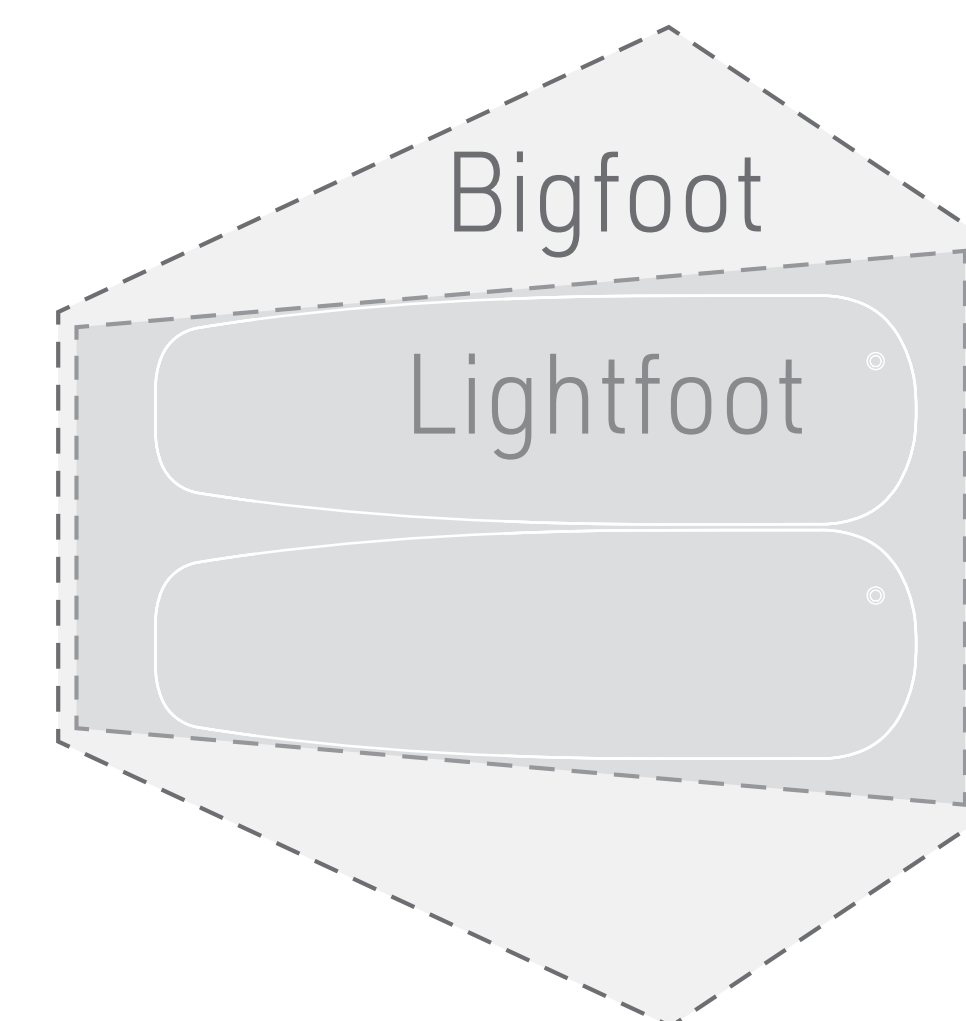

Telos TR2

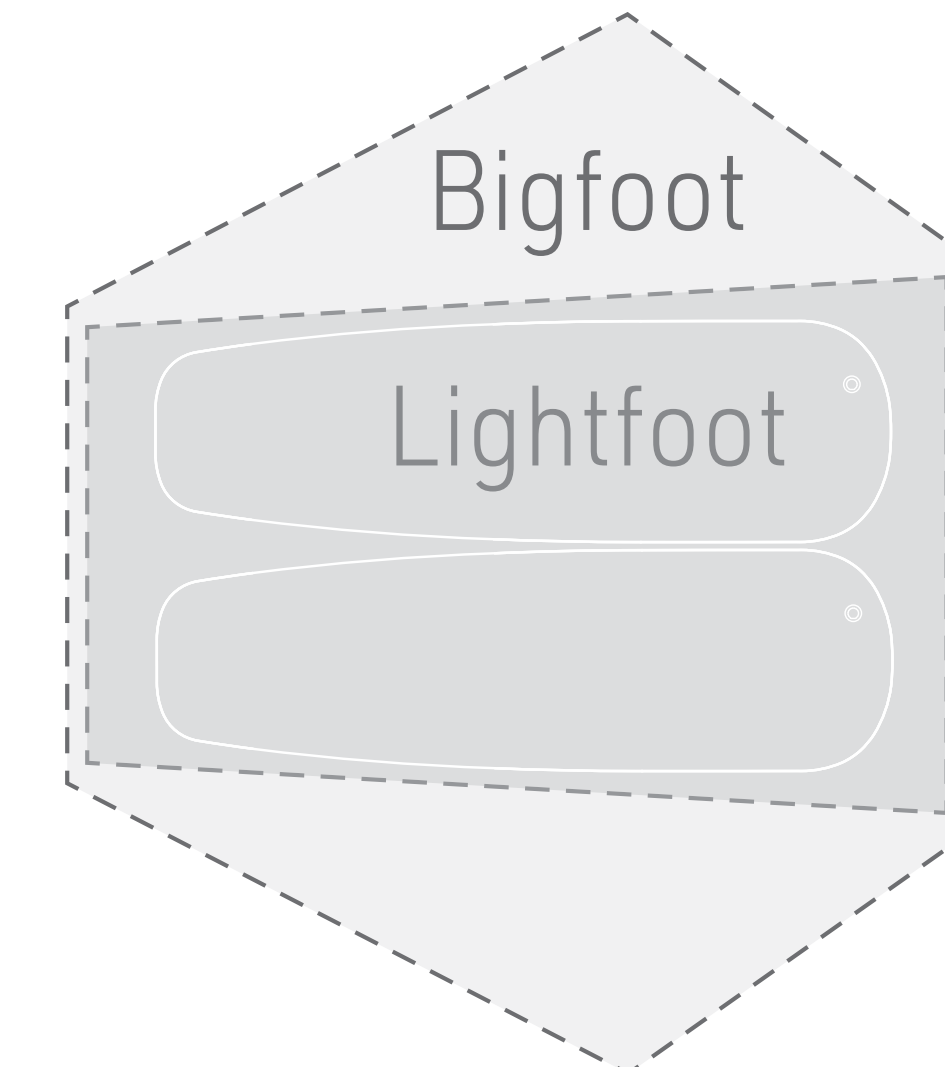

Telos TR3

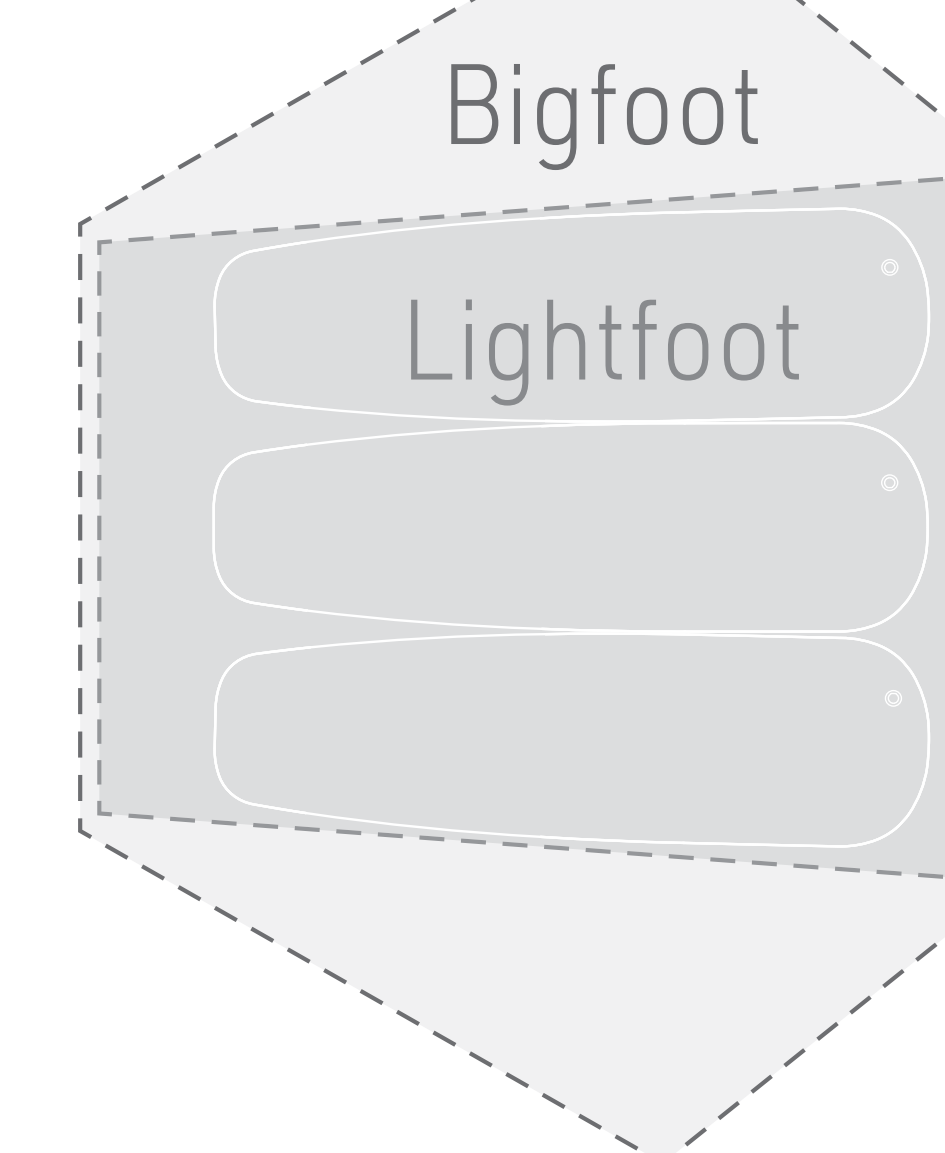

Strong Hypalon attachment points are flexible and secure



NEW



### IKOS TR2 FOOTPRINT

Protect the IKOS tent floor or a sleeping mat from groundwater, thorns, mud, and dirt with this tough, lightweight and waterproof ground sheet.

#### FEATURES

- Sized to fit under both our IKOS TR2 and IKOS TR3 tents



### IKOS TR3 FOOTPRINT





## ESCAPIST GROUND SHEET

Protect your shelter floor or sleeping mat from groundwater, thorns, mud, and dirt with this tough, lightweight and waterproof ground sheet.

### FEATURES

- Sized to fit under both our Escapist 15D Tarp shelters and our Escapist Ultra-Mesh Bug Tent







## HANGOUT MODE POLESET

Activate Hangout Mode in your Telos tent with these custom DAC Featherlite NSL poles.

### FEATURES

- Easy-to-use pole strap to keep the two-pole set bundled together
- Three-segment poles fold away to fit with the main tent pole set inside the Lightbar stuff sack



## GEAR LOFT

Stash gear within easy reach and keep it off the tent floor.

### FEATURES

- Perfect for clothes when delayering before bed
- Easily attach and detach with quick-connect V-Toggles

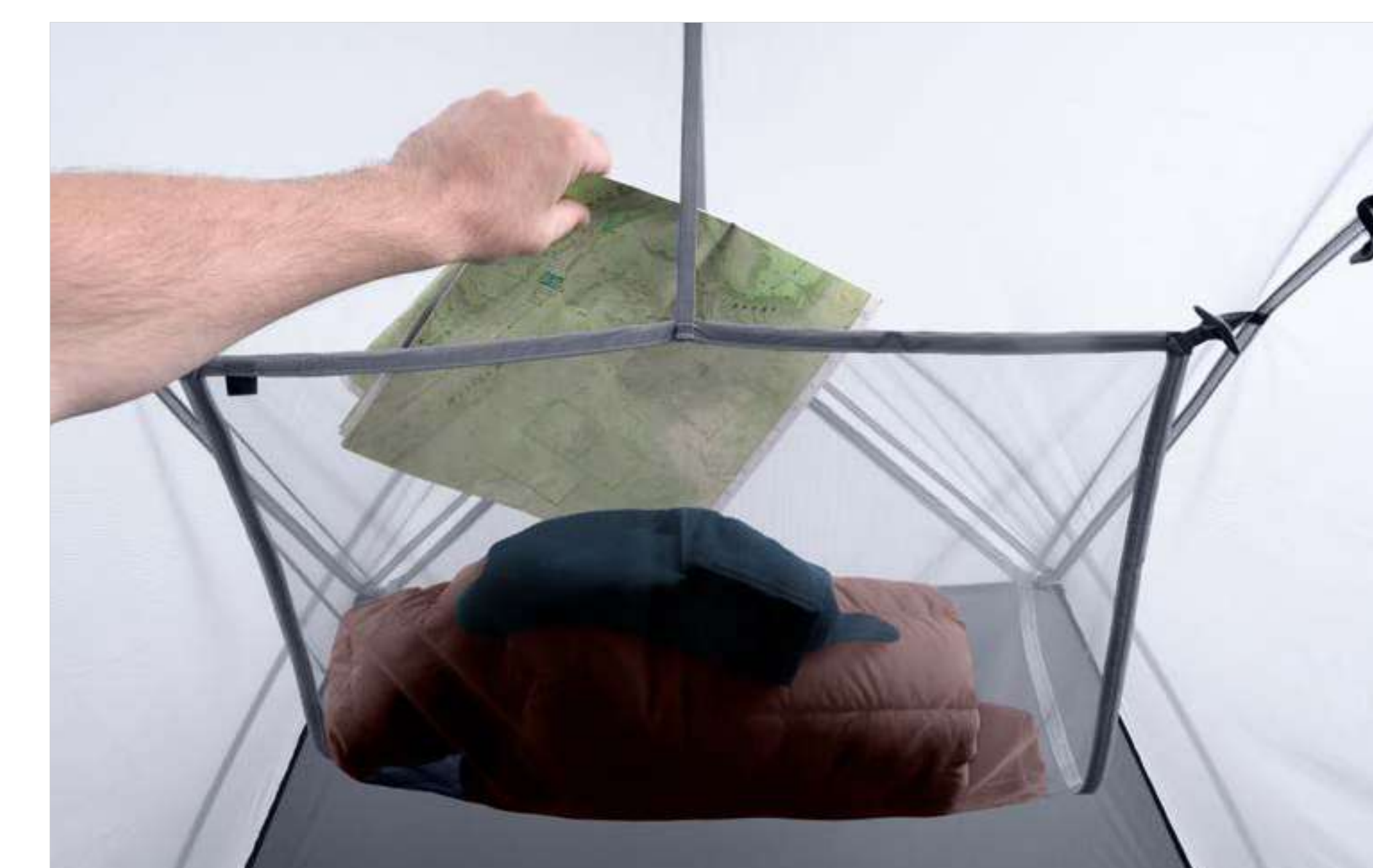



## GROUND CONTROL GUY CORDS

Make it easy to weather the storm with our quick-connect guy cords for tents and shelters.

### FEATURES

- Quick-connect, knot-free V-Toggle attachment for ease of use
- Integrated cord length adjuster—multiple guy cords can also join together for extra length
- Tightly woven, reflective cord resists tangling



## GROUND CONTROL LIGHT PEGS

Strong and ultralight premium 7 series aircraft alloy (7075-T6) tent pegs with a unique TriPoint shape.

### FEATURES

- Rigid TriPoint design maximises grip in varied ground conditions
- Multiple notches keep guy cord low and secure in hard ground
- Reflective pull-cords for easy removal and improved visibility at night



## GROUND CONTROL TENT PEGS

Light and strong three-sided replacement pegs for your tent, tarp or shelter.

### FEATURES

- Reflective cord and luminescent pull loop for peg extraction
- Multi-height guy points to reduce leverage on the peg
- Available as a pack of 8 pegs including Ultra-Sil stuff sack, or a bulk refill pack for individual sale





### TENT ACCESSORIES

PRODUCT	SUITS TENT	MODEL	CODE	DIMENSIONS	PACKED DIMENSIONS	WEIGHT	MATERIALS	RRP
Footprint	Alto TR1	Lightfoot	ATS6039-06160502	112 x 225.5cm	14 x 16 x 3cm	171g	68D PU coated Polyester, 1200mm waterhead	
		Bigfoot	ATS6039-05160501	166 x 225.5cm	20 x 16 x 4cm	224g		
	Alto TR2	Lightfoot	ATS6039-06170504	148 x 222cm	14 x 16 x 3cm	237g		
		Bigfoot	ATS6039-05170503	244 x 222cm	20 x 16 x 4cm	350g		
	Telos TR2	Lightfoot	ATS6040-06170502	144 x 222cm	14 x 16 x 3cm	243g		
		Bigfoot	ATS6040-05170501	266 x 222cm	20 x 16 x 4cm	382g		
	Telos TR3	Lightfoot	ATS6040-06180504	191 x 235cm	14 x 16 x 3cm n	338g		
		Bigfoot	ATS6040-05180503	349 x 235cm	20 x 16 x 4cm	511g		

PRODUCT NAME	CODE	SIZE	PACKED DIMENSIONS	WEIGHT	MATERIALS	RRP
Ikos TR2 Footprint 2 Person	ATS033091-170501	270 x 210cm	20 x 11 x 5cm	TBC	68D Polyester	
Ikos TR3 Footprint 3 Person	ATS033091-180502	370 x 220cm	20 x 11 x 5cm	TBC	68D Polyester	
Escapist Ground Sheet	AESCGS	220 x 130cm	20 x 11 x 5cm	165g	Lightweight Tyvek®	



## TENT ACCESSORIES

PRODUCT	SUITS TENT	CODE	DIMENSIONS	PACKED DIMENSIONS	WEIGHT	MATERIALS	RRP
Telos Hangout Mode Pole Set		ATS0040-00130501	125cm	ø3 x 45cm	135g	DAC Featherlite NSL 8.5mm & 9.0mm Anodised Aluminum	
Gear Loft	Alto TR1	ATS0039-01160501	100 x 39 x 0.5cm		24g		
	Alto TR2	ATS0039-01170502	89 x 56 x 0.5cm	23 x 13 x 2.5cm	28g	15D Polyester Mesh	
	Telos TR2	ATS0040-01170501	72 x 59 x 0.5cm		24g		
	Telos TR3	ATS0040-01180502	68 x 85 x 0.5cm		26g		

PRODUCT NAME	CODE	SIZE	DIMENSIONS	WEIGHT	MATERIALS	RRP
Ground Control Guy Cords	ATS0085-00121702	4 pack	2 x 2.2m & 2 x 1m	18g	UV-resistant Polyester cord	
Ground Control Light Pegs	ATS0085-00120201	6 pack	1 x 15cm	7g (ea)	7075-T6 Anodised Aluminium Alloy	
	APEGS8PK	8 Pack	1 x 20cm	118g	7075-T6 Anodised Aluminium Alloy	
Ground Control Tent Pegs	APEG	Bulk (x20)		12g (ea)		

# STORAGE

DRY BAGS, STUFF SACKS,  
+ COMPRESSION BAGS



# INSPIRED BY THE OUTBACK

A COLOUR PALETTE INSPIRED BY THE WILD AND REMOTE NATURAL LANDSCAPES OF OUR WESTERN AUSTRALIAN HOME

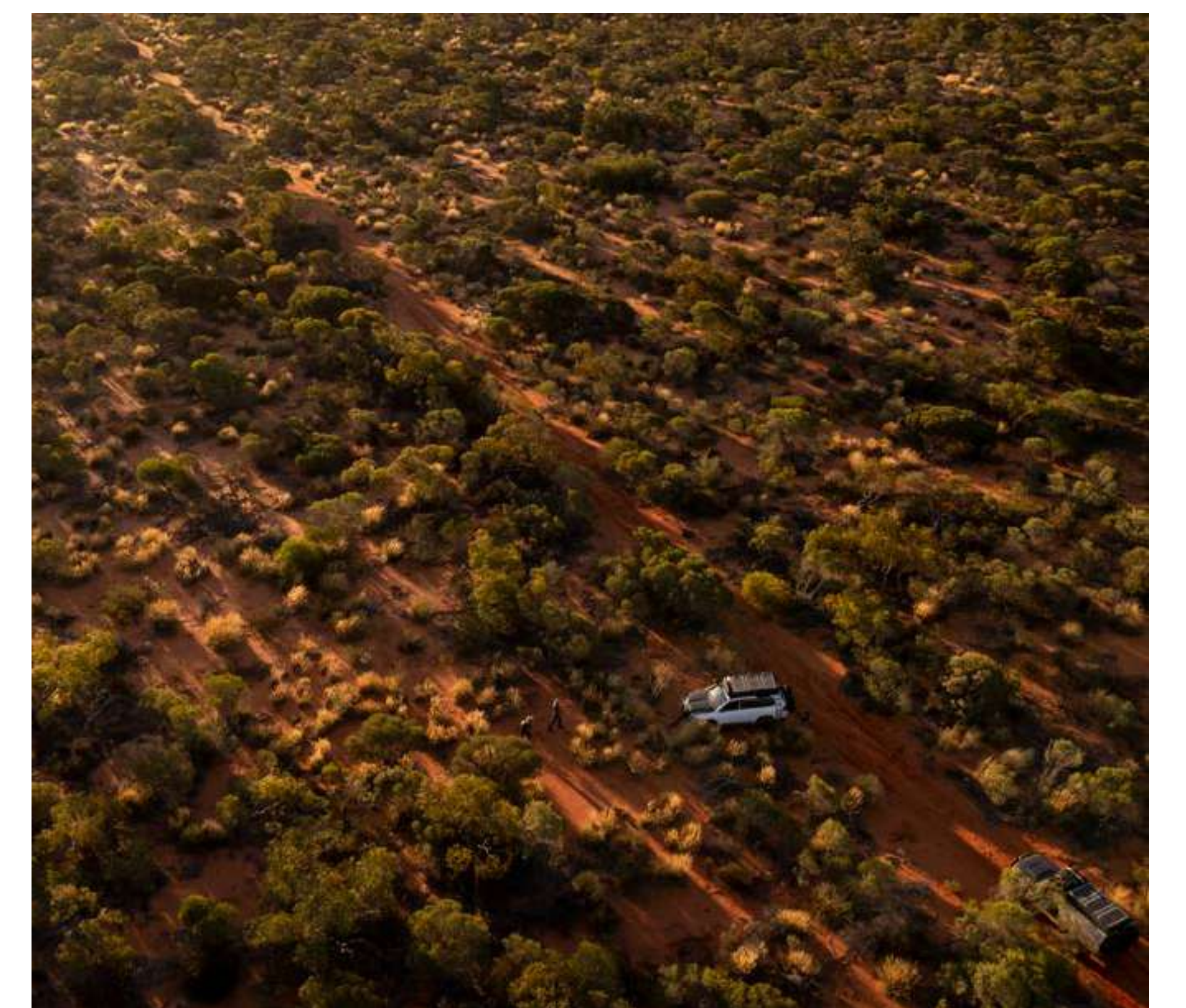
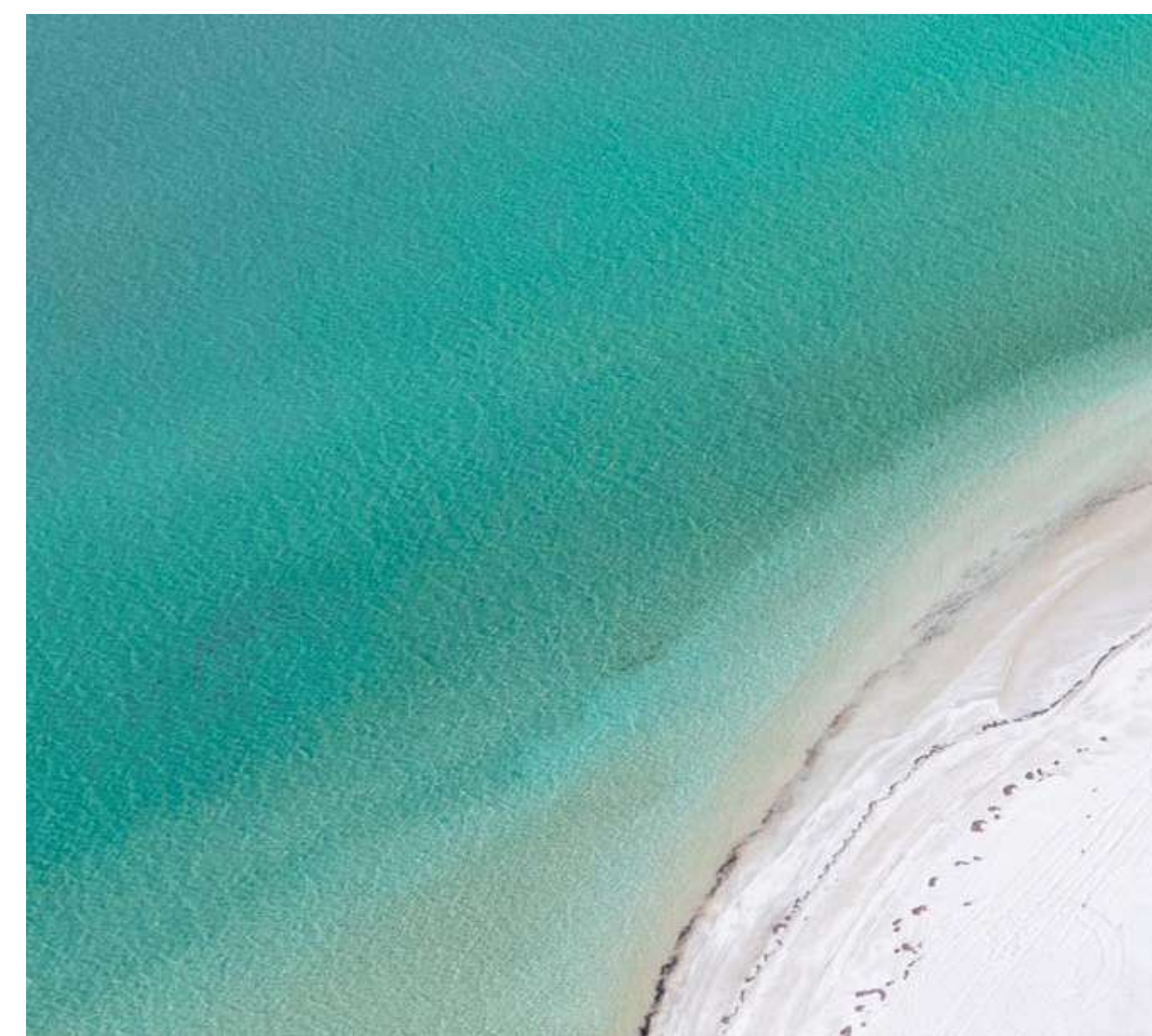
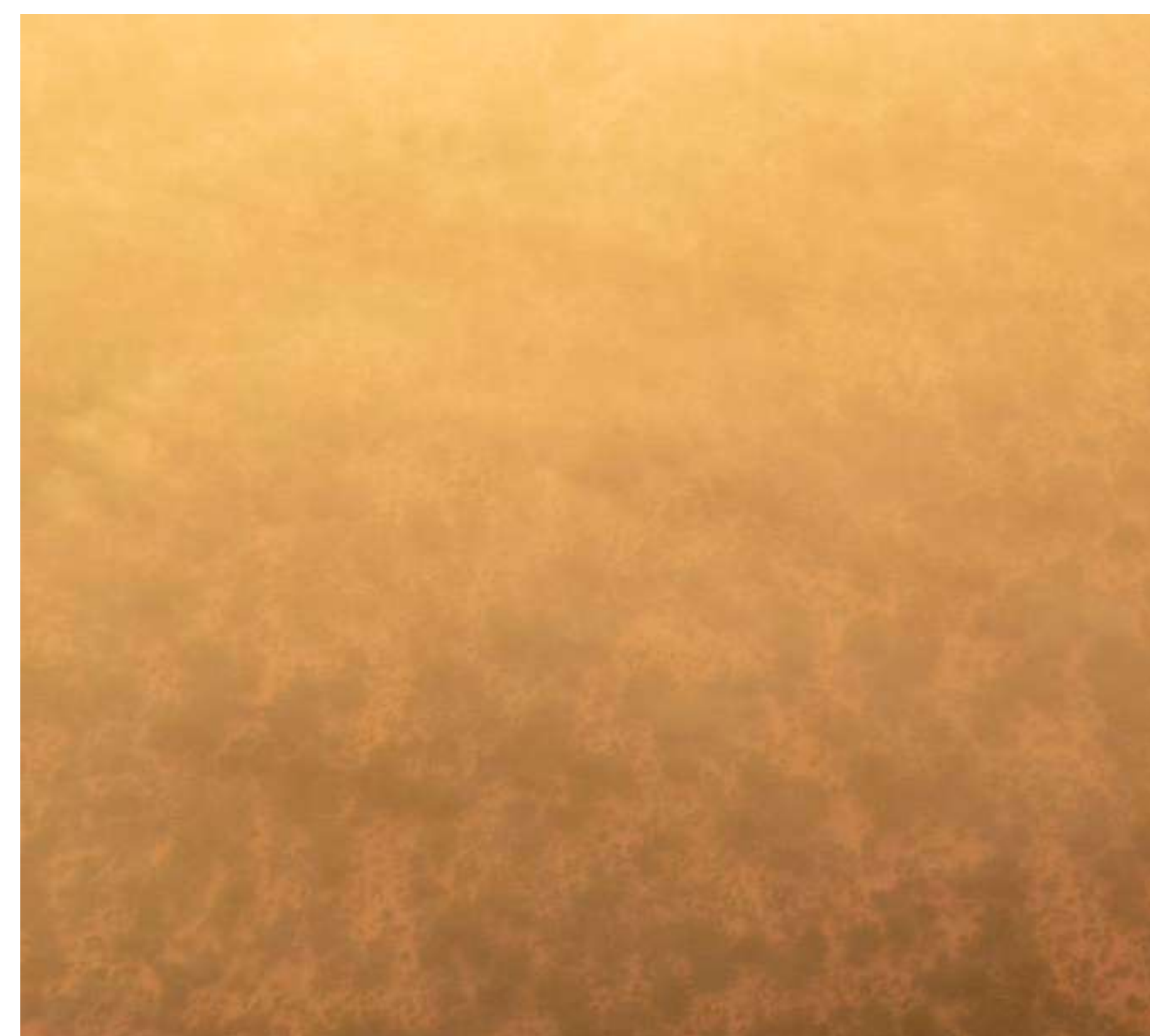
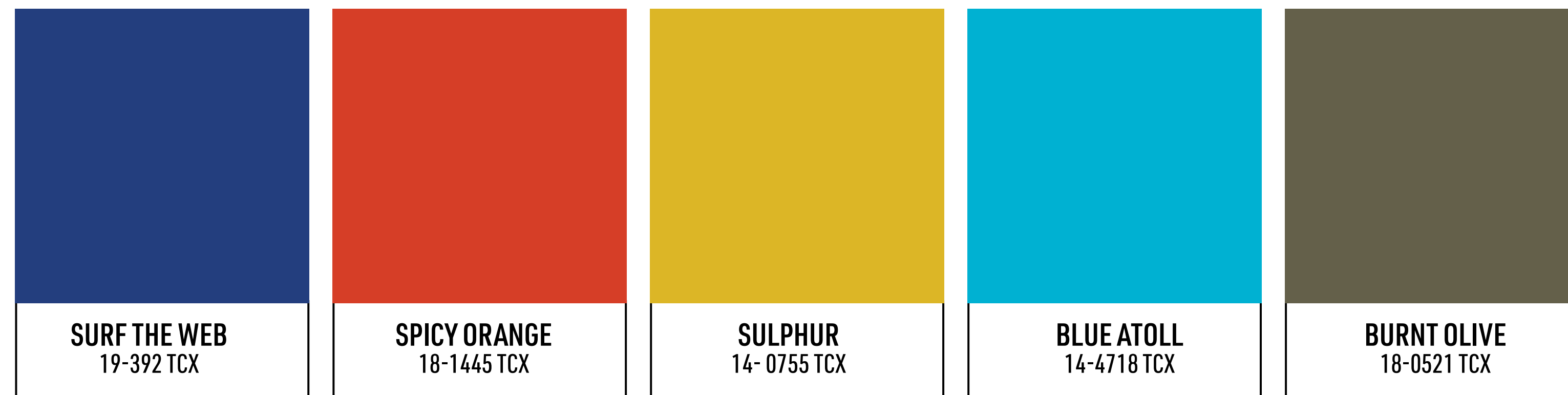



# STORAGE

## A BAG FOR EVERY ADVENTURE

### DECADES OF INNOVATION

For more than 30 years, we've remained committed to constantly developing and refining our range of storage products. We strive for excellence and relentlessly field-test our gear. That's why we're the world's most trusted name in the category.

### BROADEST RANGE

We consistently push the limits of innovation, design and material development, which has led to the largest, most awarded range of dry and non-dry storage products available.

### MARKET LEADER

Our commitment to innovation and proven performance has made Sea to Summit the leading brand for high-quality Dry Bags, Stuff Sacks and Compression Bags for more than a decade.



**DRY BAGS**

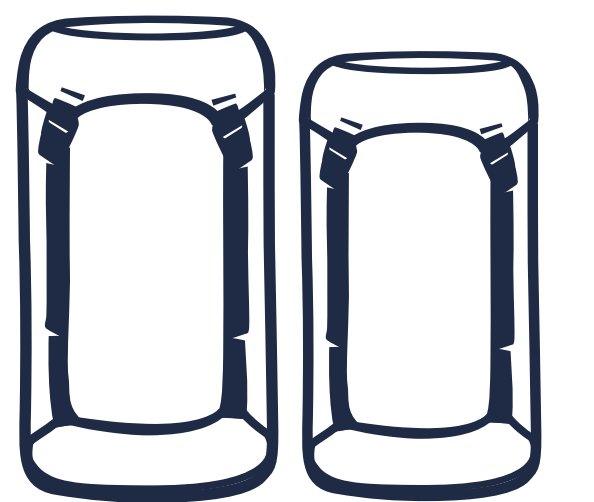

**EVAC COMPRESSION DRY BAGS**

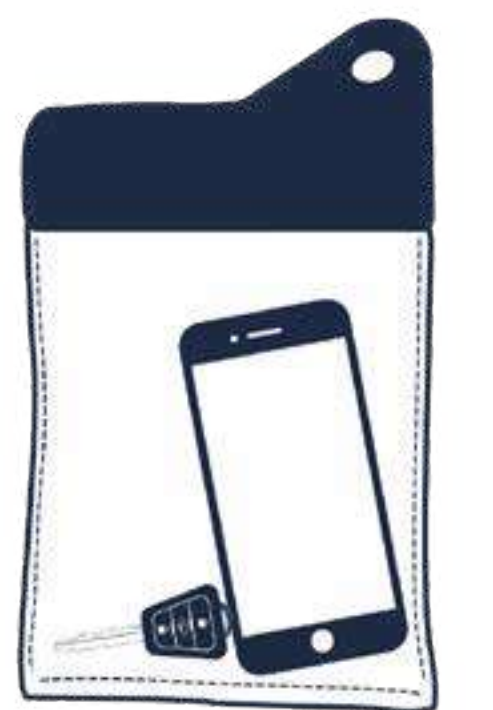

**DRY ORGANISATION AND ACCESSORY CASES**



**STUFF + COMPRESSION SACKS**



## HEAVY DUTY

## LIGHTWEIGHT

## ULTRA LIGHT

## EVAC



BIG RIVER DRY BAG



LIGHTWEIGHT DRY BAG



ULTRA-SIL DRY BAG



EVAC DRY BAG



BIG RIVER DRY BACKPACK



LIGHTWEIGHT STUFF SACK



ULTRA-SIL STUFF SACK



EVAC COMPRESSION DRY BAG



HYDRAULIC PRO DRY PACK



LIGHTWEIGHT COMPRESSION SACK



ULTRA-SIL COMPRESSION SACK



EVAC COMPRESSION DRY BAG UL



EVAC COMPRESSION DRY BAG HD

### WHO WE DESIGNED IT FOR:

Outdoor users whose land and water-based adventures require the toughest dry storage solutions

### WHAT ACTIVITIES IS IT USED FOR:

Paddling, Whitewater, Overland Motorcycling, 4WD

### WHO WE DESIGNED IT FOR:

Outdoor users who move in wet environments who want to create order and / or maximise space in their backpacks and bags

### WHAT ACTIVITIES IS IT USED FOR:

Paddling, Sea Kayaking (Lightweight Dry Sack) Vehicle-based camping, Hunting

### WHO WE DESIGNED IT FOR:

The gram counting user who wants function and convenience without adding unnecessary weight to a pack

### WHAT ACTIVITIES IS IT USED FOR:

Backpacking, Ski-touring, Long-distance Travel

### WHO WE DESIGNED IT FOR:

Space-conscious outdoor users who need to keep gear –both internally and externally mounted –dry and organised

### WHAT ACTIVITIES IS IT USED FOR:

Backpacking, Sea Kayaking, Overland Motorcycling, Hunting, 4WD



# DRY BAGS

For 2023 we have completely re-engineered our Dry Bags: more innovation, more quality materials, more options. Same attention to detail and proven construction.

## WHAT MAKES A SEA TO SUMMIT DRY BAG?

### DETAILS

Non-wicking hypalon closure strip ensures moisture is not drawn into the bag when rolled shut.

### FIELD REPAIR BUCKLE

Field Repair Buckles can be replaced quickly with just a screwdriver

### STRONG, WATERPROOF SEAMS

Double-sewn and seam taped





# DRY BAGS OVERVIEW



PRODUCT	HYDRAULIC PRO DRY PACK	BIG RIVER DRY BAG	BIG RIVER DRY BACKPACK	LIGHTWEIGHT DRY BAG	LIGHTWEIGHT DRY BAG VIEW	LIGHTWEIGHT DRY BAG FIRST AID	EVAC DRY BAG	ULTRA-SIL DRY BAG
	HEAVY DUTY			LIGHTWEIGHT				ULTRA LIGHT
VOLUME (LITRES)	50 75 100	5 8 13 20 35 65	50 75	1.5 3 5 8 13 20 35	5 8 13	1 3	3 5 8 13 20 35	3 5 8 13 20 35
FABRIC	1000D TPU-Laminated Fabric	420D TPU-Laminated Nylon	420D TPU-Laminated Nylon	bluesign® APPROVED 70D PU-Coated traceable recycled nylon, C0 non-PFC DWR finish	bluesign® APPROVED 70D PU-Coated traceable recycled nylon, C0 non-PFC DWR finish	bluesign® APPROVED 70D PU-Coated traceable recycled nylon, C0 non-PFC DWR finish	bluesign® APPROVED 70D PU-Coated traceable recycled nylon, C0 non-PFC DWR finish. 70D Nylon with eVent® laminate base	bluesign® APPROVED 30D PU-Coated / Siliconised CORDURA® nylon, C0 non-PFC DWR finish
	<b>1000D</b> HYDRAULIC FABRIC	<b>420D</b> WATERPROOF FABRIC	<b>420D</b> WATERPROOF FABRIC	<b>70D</b> WATERPROOF FABRIC	<b>70D</b> WATERPROOF FABRIC	<b>70D</b> WATERPROOF FABRIC	<b>70D</b> WATERPROOF FABRIC	<b>30D</b> ULTRA-SIL
WATERHEAD (MM)	10,000+	10,000	10,000	10,000	10,000	10,000	10,000	2,000
BASE		OVAL	OVAL	OVAL	OVAL	OVAL	OVAL	OVAL
COLOURS								



# HYDRAULIC PRO DRY PACK

The dry pack that thrives under pressure





# HYDRAULIC PRO DRY PACK **NEW**

Fully submersible duffle-style dry pack for the most extreme environments and conditions.

Tough and intelligent: the perfect synthesis of smart and strong.

## FEATURES

- Airtight and fully submersible: Pressure tested waterproof TIZIP® MasterSeal and RF-welded seams meet IPX8 submersion rating
- Ultra-durable 1000D high tenacity double sided TPU-laminated fabric
- Fully welded seams, airtight waterproof zipper makes this bag fully submersible and nearly indestructible.
- Unique asymmetrical zipper design enables easy access to contents.
- Removable and adjustable shoulder harness allows large load to be carried comfortably or bag to be lashed down for secure transport.

## SIZES

50L / 75L / 100L

## COLOURS



Zinnia  
Picante

Jet Balck  
Bleuga



**1000D** HYDRAULIC FABRIC



# BIG RIVER DRY BAG

Flexible, durable and now  
even more functional





# BIG RIVER DRY BAG **UPDATED**

The first choice for hardcore adventures on land and water

Lash to kayaks, bikes and 4WDs with confidence, or add a Dry Bag Sling for comfortable hands-free carrying

### FEATURES

- Low profile grab handles—easy to grab and carry
- Base Lash Loop for Dry Bag Sling attachment (5, 8, 13, 20, 35L only) (rated to 15kg loads)
- Triple-coated oval base for increased water shedding and durability
- Hypalon non-wicking roll-top closure
- 420D ripstop nylon shrugs off water and abrasion
- Multiple lash points provide secure mounting options for bikepacking, kayaking, overland motorcycling, rafting, 4WDs

### SIZES

5L / 8L / 13L / 20L / 35L / 65L

### COLOURS

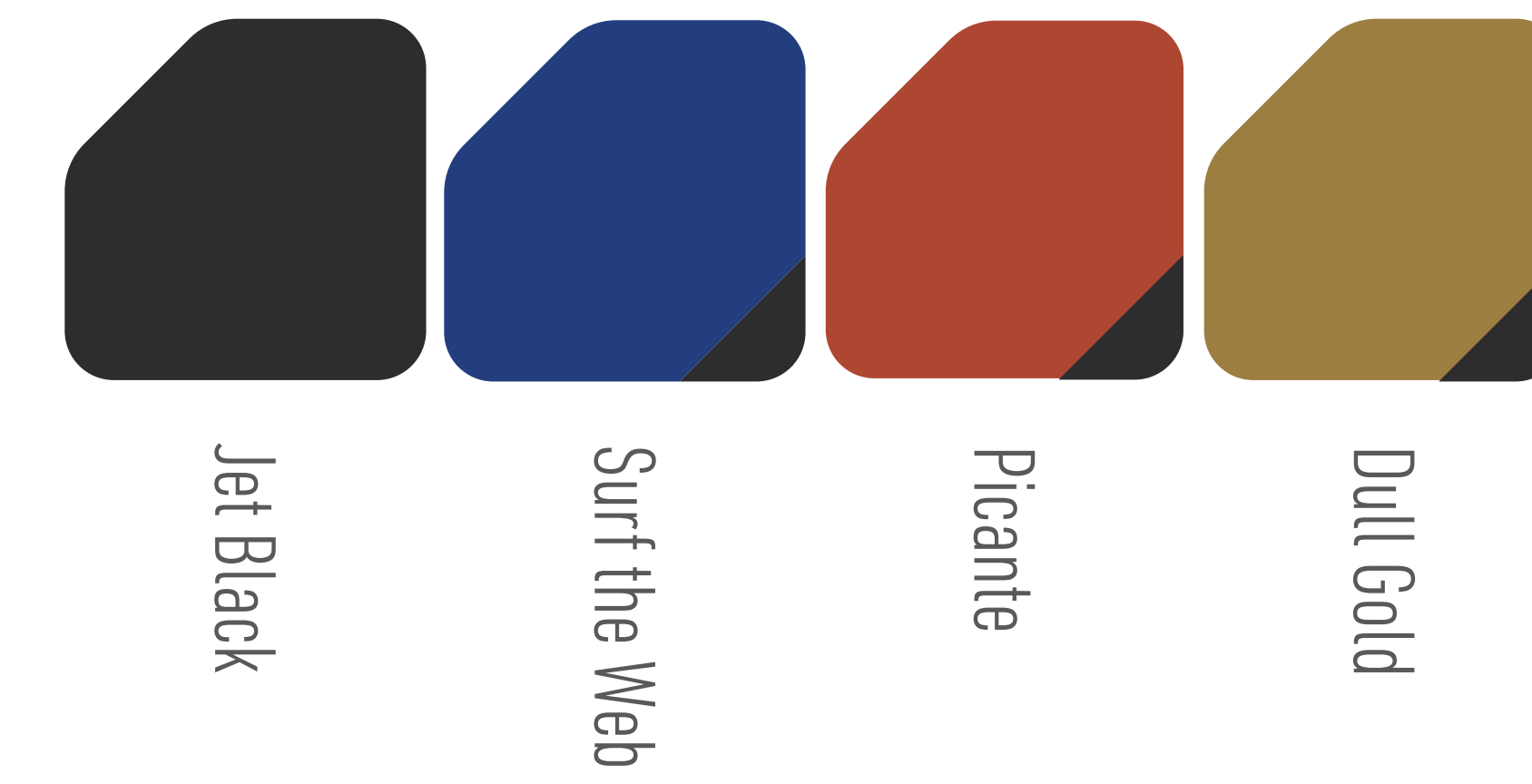

**420D WATERPROOF FABRIC**



Multiple lash points provide versatility for mounting to kayaks, bikes, motorbikes and 4WDs



Triple-coated oval base increases durability and water shedding



Convenient low-profile grab handles for snag resistance



Super strong 420D nylon shrugs off water and abrasion





# BIG RIVER DRY BACKPACK

Waterproof, durable and minimalist  
backpack for rugged adventures



# BIG RIVER DRY BACKPACK **NEW**

Waterproof, durable minimalist backpack  
—your go-to, wherever you go

Keep your gear reliably dry—and carry it comfortably on your back

## FEATURES

- Low profile grab handles—easy to grab and carry
- Triple-coated oval base for increased water shedding and durability
- Hypalon non-wicking roll-top closure
- Adjustable sternum strap
- 420D ripstop nylon shrugs off water and abrasion

## SIZES

50L / 75L

## COLOURS

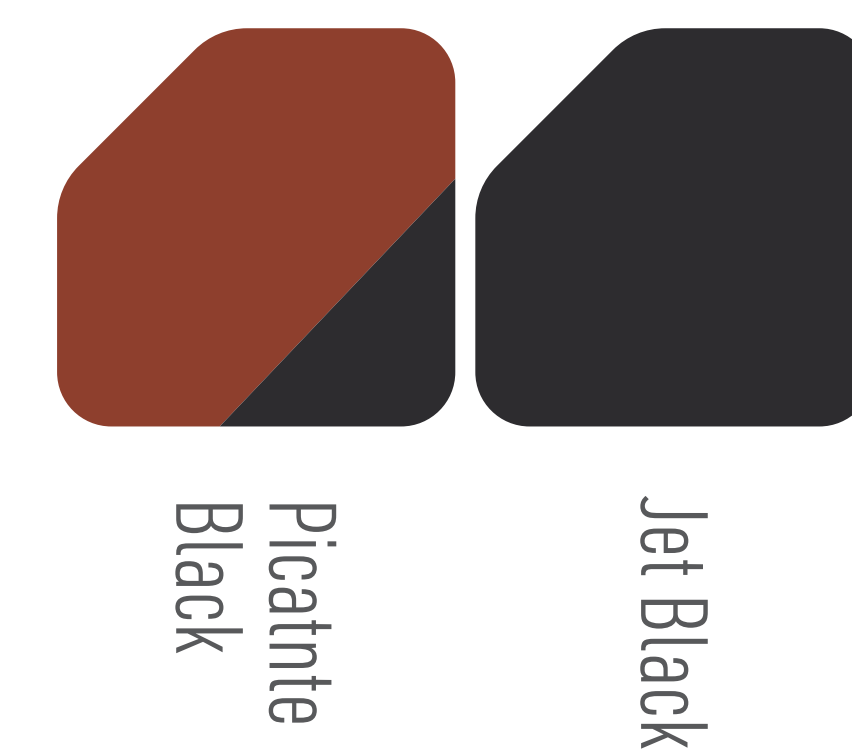

Picante Black

Jet Black



**420D** WATERPROOF FABRIC



Triple-coated oval base increases durability and water shedding



Convenient low-profile grab handles for snag resistance



Super strong 420D nylon shrugs off water and abrasion







### DRY BAGS (HEAVY DUTY)

PRODUCT NAME	CODE	SIZE	DIMENSIONS	BASE	WEIGHT	COLOUR	RRP
Hydraulic Pro Dry Pack	ASG013021-06	50L	28 x 62 x 32cm	Oval	1585g		
	ASG013021-42	75L	31 x 68 x 36cm		1817g		
	ASG013021-43	100L	35 x 80 x 40cm		1960g		
Big River Dry Bag	ASG012041-03	5L	32.3 x 16.8 x 14.3cm	Oval	135g		
	ASG012041-04	8L	37.4 x 19.3 x 16.5cm		160g		
	ASG012041-05	13L	44 x 22 x 20cm		192g		
	ASG012041-06	20L	48.1 x 26.4 x 24.4cm		250g		
	ASG012041-07	35L	58.6 x 31.7 x 28.1cm		308g		
Big River Dry Backpack	ASG013031-08	50L	60.4 x 34.5 x 45.4cm	Oval	760g		
	ASG013031-42	75L	67.5 x 36.5 x 48cm		820g		



FIRST AID DRY BAG



LIGHTWEIGHT DRY BAG



VIEW DRY BAG



# LIGHTWEIGHT DRY BAGS



# LIGHTWEIGHT DRY BAGS **UPDATED**

Versatile, lightweight waterproof storage for your adventures

Keep your gear and first aid supplies reliably dry and organised for quick access



LIGHTWEIGHT DRY BAG



VIEW DRY BAG



FIRST AID DRY BAG

COLOURS



Beluga  
Surf the Web  
Burnt Olive  
Spicy Orange  
Sulphur



Surf the Web



Spicy Orange

FEATURES

- Waterproof, roll-top hypalon closure secured with our Field Repair Buckle for a reliable seal
- Double-stitched and fully taped waterproof seams
- bluesign® APPROVED traceable recycled 70D nylon fabric uses a C0 non-PFC DWR finish
- Light-reflecting white interior for better visibility of gear
- VIEW: Clear TPU window to see contents and for easy organisation
- FIRST AID: Easily identifiable first aid kit with clear TPU window to find what you need fast
- New Base Lash Loop feature compatible with optional Dry Bag Sling shoulder strap (Lightweight and View Dry Bag only)

SIZES

LIGHTWEIGHT DRY BAG: 1.5L / 3L / 5L / 8L / 13L / 20L / 35L  
 VIEW DRY BAG: 5L / 8L / 13L  
 FIRST AID DRY BAG: 1L / 3L



**SUSTAINABLE DESIGN**

- CO Non-PFC Water Repellent Finish
- 100% RCS Nylon main body fabric
- bluesign® APPROVED main body fabric



### DRY BAGS (LIGHTWEIGHT)

PRODUCT NAME	CODE	SIZE	DIMENSIONS	WEIGHT	BASE	COLOUR	RRP
Lightweight Dry Bag First Aid	ASG012121-01	1L	16.3 x 11.2 x 9.4cm	32g	Oval		
	ASG012121-02	3L	21.3 x 17 x 13.3cm	47g			
Lightweight Dry Bag View	ASG012131-03	5L	32 x 16.8 x 14cm	52g	Oval		
	ASG012131-04	8L	39 x 19.9 x 16.5cm	65g			
	ASG012131-05	13L	45.9 x 22 x 20cm	81g			
Lightweight Dry Bag	ASG012011-01	1.5L	19 x 14.1 x 10.7cm	34g	Oval		
	ASG012011-02	3L	21.3 x 17 x 13.3cm	45g			
	ASG012011-03	5L	32 x 16.8 x 14cm	50g			
	ASG012011-04	8L	39 x 19.9 x 16.5cm	67g			
	ASG012011-05	13L	45.9 x 22 x 20cm	81g			
	ASG012011-06	20L	47.8 x 27.1 x 23.4cm	91g			
	ASG012011-07	35L	55.6 x 31.5 x 28.8cm	115g			
Lightweight Dry Bag 3-Piece Set	ASG012111-12	3, 5, 8L			Oval		
	ASG012111-12	8, 13, 20L					



# ULTRA-SIL DRY BAG

An ultra-light 30D CORDURA® nylon fabric storage essential for adventurers





# ULTRA-SIL DRY BAG **UPDATED**

An ultra-lightweight dry bag built in 30D siliconised CORDURA<sup>®</sup> nylon, our Ultra-Sil Dry Bag is an essential component of any fast and light adventure

Keep gear reliably dry and organised inside your pack

## FEATURES

- Waterproof, roll-top hypalon closure secured with our Field Repair Buckle for a reliable seal
- Ultralight and super-strong, 30D diamond ripstop siliconised CORDURA<sup>®</sup> Nylon fabric has a 2000mm hydrostatic head
- bluesign<sup>®</sup> APPROVED fabric with a CO non-PFC DWR finish
- Oval base prevents rolling and packs efficiently
- Slippery finish slides into tight spaces in your pack or bag

## SIZES

3L / 5L / 8L / 13L / 20L / 35L

## COLOURS

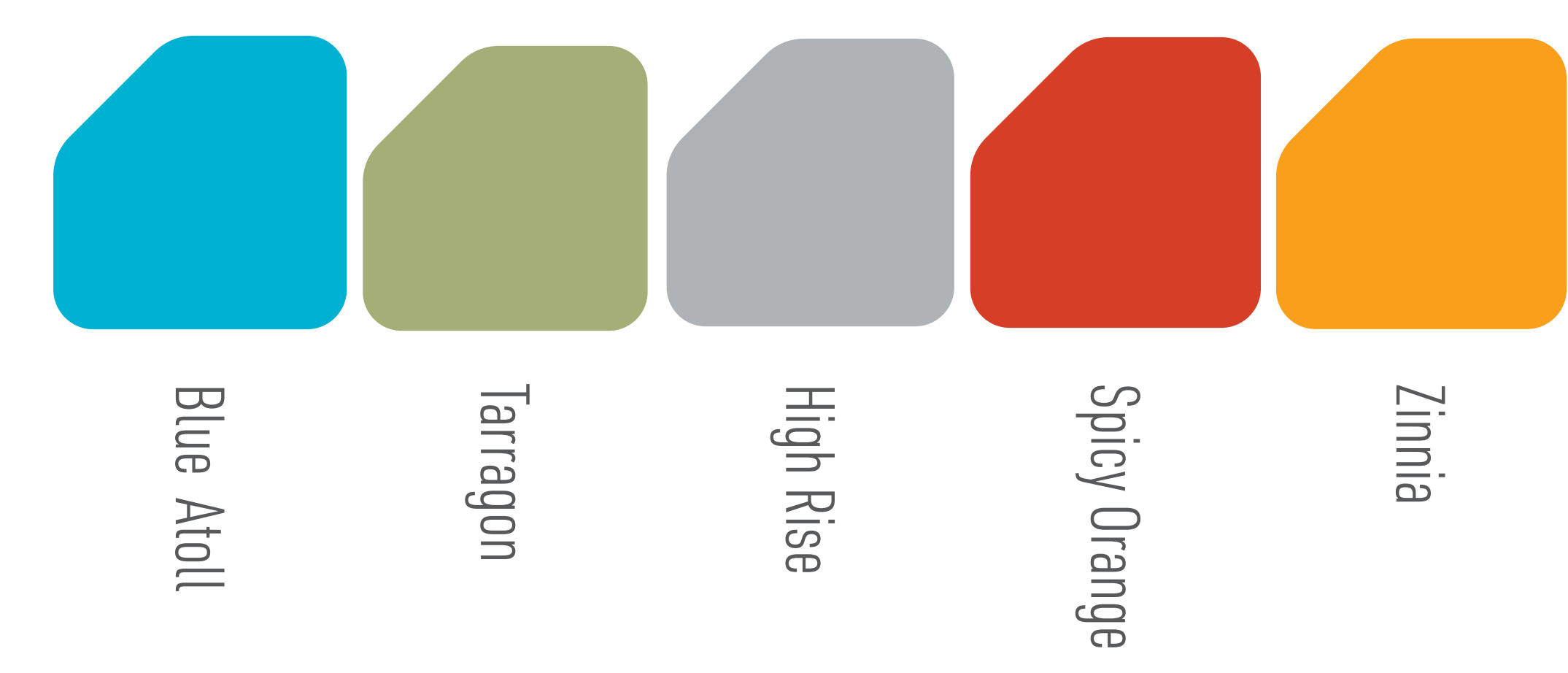

**30 D ULTRA-SIL**



**SUSTAINABLE DESIGN**

- CO Non-PFC Water Repellent Finish
- bluesign<sup>®</sup> APPROVED main body fabric



### ULTRALIGHT DRY BAGS

PRODUCT NAME	CODE	SIZE	DIMENSIONS	BASE	WEIGHT	COLOUR	RRP
Ultra-Sil Dry Bag	ASG012021-02	3L	20.7 x 17.1 x 14cm	Oval	30g		
	ASG012021-03	5L	30.8 x 17.1 x 15cm		32g		
	ASG012021-04	8L	36.8 x 19.1 x 17.2cm		39g		
	ASG012021-05	13L	43.3 x 22 x 19.6cm		47g		
	ASG012021-06	20L	47.3 x 26.9 x 23.6cm		58g		
	ASG012021-07	35L	56.5 x 32.1 x 28.5cm		74g		
	Ultra-Sil Dry Bag 3-Piece Set	ASG012151-12	3, 5, 8L				100g

# EVAC COMPRESSION DRY BAGS

Air compresses out, water can't get in—keep your bulky soft gear dry and compressed for compact packing.



## OUR COMPRESSION DRY BAGS FEATURE:

### EASY ACCESS

Compression strap side-release buckles allow fast and easy access

### WATERPROOF SEAL

Waterproof, roll-top hypalon closure secured with our Field Repair Buckle for a reliable seal

### EVENT® FABRIC BASE

Waterproof and air permeable base allows air to be pushed out but water can't get in—completely valve-free.

### PULL HANDLE

on the bottom.







# EVAC DRY BAGS OVERVIEW



PRODUCT	EVAC COMPRESSION DRY BAG HD	EVAC COMPRESSION DRY BAG	EVAC DRY BAG	EVAC COMPRESSION DRY BAG UL
	HEAVY DUTY	LIGHTWEIGHT		ULTRALIGHT
VOLUME (LITRES)	8 13 20 35	5 8 13 20 35	3 5 8 13 20 35	3 5 8 13
FABRIC	420D TPU-Laminated Nylon 500D eVent® CORDURA®	bluesign® APPROVED 70D PU-Coated traceable recycled nylon body fabric, C0 non-PFC DWR finish 70D eVent® Laminate base	bluesign® APPROVED 70D PU-Coated traceable recycled nylon body fabric, C0 non-PFC DWR finish 70D eVent® Laminate base	bluesign® APPROVED 30D PU-Coated / Siliconised CORDURA® nylon, C0 non-PFC DWR finish 70D eVent® Laminate Base
	<b>420D</b> WATERPROOF FABRIC	<b>70D</b> WATERPROOF FABRIC	<b>70D</b> WATERPROOF FABRIC	<b>30D ULTRA-SIL</b>
WATERHEAD (MM)	10,000	10,000	10,000	2000
BASE	OVAL 	OVAL 	OVAL 	ROUND 
COLOURS				



# EVAC COMPRESSION DRY BAG HD

Waterproof, rugged, compressible





# EVAC COMPRESSION DRY BAG HD **NEW**

## Waterproof and ready for any adventure

Keep your compressible gear reliably dry and compact—air compresses out, water can't get in

### FEATURES

- Valve-free design with eVent® CORDURA® nylon base: compression for sleeping bags, clothing and other compressible gear.
- Waterproof, highly-durable hypalon roll-top closure secured with our Field Repair Buckle.
- Super-strong, abrasion and puncture-resistant 420D body fabric keeps contents dry and protected in extreme conditions
- Strong and secure lash loops for attaching to kayaks, bikes, motorbikes and roof-racks.

### SIZES

8L / 13L / 20L / 35L

### COLOURS



Jet Black  
Zinnia



**420D** WATERPROOF FABRIC





# EVAC COMPRESSION DRY BAG **UPDATED**

## Award-Winning ultra-versatile waterproof soft gear storage

Perfect dry compression storage for everything from bikepacking to sea kayaking and beyond

### FEATURES

- Waterproof, roll-top hypalon closure secured with our Field Repair Buckle
- Valve-free, air-permeable eVent® fabric base allows soft items to compress and save space.
- bluesign® APPROVED traceable recycled 70D nylon main body fabric uses a CO non-PFC DWR finish
- 70D eVent® fabric base is non-PFC

### SIZES

5L / 8L / 13L / 20L / 35L

### COLOURS



High Rise  
Jet Black

Turkish Tile  
Jet Black



**70D** WATERPROOF FABRIC

**eVent**  
WATERPROOF

**NON PFC**



**SUSTAINABLE DESIGN**

- CO Non-PFC Water Repellent Finish
- 100% RCS Nylon main body fabric
- bluesign® APPROVED main body fabric



# EVAC COMPRESSION DRY BAG UL UPDATED

**Waterproof and space-saving ultra-lightweight soft gear organisation**

Keep your compressible gear reliably dry and compact



## FEATURES

- Waterproof, roll-top hypalon closure secured with our Field Repair Buckle
- Valve-free, air-permeable eVent® fabric base is non-PFC
- bluesign® APPROVED Ultra-Sil 30D CORDURA® nylon uses a CO non-PFC DWR finish
- Compression strap side-release buckles allow fast and easy access
- Waterproof seams you can trust—double-stitched and tape-sealed

## SIZES

5L / 8L / 13L / 20L / 35L

## COLOURS



**30 D ULTRA-SIL**

**eVent®**  
WATERPROOF

**NON PFC**

**SUSTAINABLE DESIGN**

- CO Non-PFC Water Repellent Finish
- bluesign® APPROVED main body fabric



# EVAC DRY BAG

Dry Bags and Compression Dry Bags integrated with eVent® technology designed to get the air out, and keep the dry in



# EVAC DRY BAG UPDATED

A classic minimal lightweight Dry Bag with an eVent® base

Keep your compressible gear dry—air squeezes out, water can't get in.



## FEATURES

- Waterproof, roll-top hypalon closure secured with our Field Repair Buckle
- Valve-free air permeable eVent® fabric base allows soft items to be compressed
- Double-stitched and fully-taped waterproof seams
- bluesign® APPROVED traceable recycled 70D nylon main body fabric uses a CO non-PFC DWR finish
- 70D eVent® fabric base is non-PFC
- New Base Lash Loop feature compatible with optional Dry Bag Sling shoulder strap
- Oval shape stacks and packs easily.

## SIZES

3L / 5L / 8L / 13L / 20L / 35L

## COLOURS



Beluga

Turkish Tile



**70D** WATERPROOF FABRIC

**eVent**® WATERPROOF

**NON PFC**

**SUSTAINABLE DESIGN**

- CO Non-PFC Water Repellent Finish
- 100% RCS Nylon main body fabric
- bluesign® APPROVED main body fabric



## EVAC COMPRESSION DRY BAGS

PRODUCT NAME	CODE	SIZE	DIMENSIONS	BASE	WEIGHT	COLOUR	RRP
Evac Compression Dry Bag HD	ASG011041-04	8L	37.5 x 19.8 x 16.5cm	Oval	220g		
	ASG011041-05	13L	44 x 21.7 x 19.7cm		237g		
	ASG011041-06	20L	46.3 x 26.9 x 24.5cm		310g		
	ASG011041-07	35L	57.2 x 31.7 x 28cm		370g		
Evac Compression Dry Bag	ASG011031-03	5L	31.2 x 16.6 x 14.7cm	Oval	98g		
	ASG011031-04	8L	44.7 x 22 x 20.2cm		113g		
	ASG011031-05	13L	56 x 32 x 29.3cm		136g		
	ASG011031-06	20L	39.4 x 19.2 x 17.8cm		160g		
	ASG011031-07	35L	45.7 x 26.5 x 23.5cm		189g		
Evac Compression Dry Bag UL	ASG011051-02	3L	26.7 x 13.2 x 13.2cm	Oval	57g		
	ASG011051-03	5L	37.7 x 17.9 x 17.9cm		64g		
	ASG011051-04	8L	47.6 x 24.2 x 24.2cm		76g		
	ASG011051-05	13L	31.5 x 15.2 x 15.2cm		94g		
	ASG011051-06	20L	43.2 x 21 x 21cm		110g		
Evac Dry Bag	ASG012031-02	3L	21.3 x 17 x 13.3cm	Oval	43g		
	ASG012031-03	5L	32 x 16.8 x 14cm		50g		
	ASG012031-04	8L	39 x 19.9 x 16.5cm		60g		
	ASG012031-05	13L	45.9 x 22 x 20cm		72g		
	ASG012031-06	20L	47.8 x 27.1 x 23.4cm		95g		
	ASG012031-07	35L	55.6 x 31.5 x 28.8cm		113g		





## DRY BAG SLING

Detachable strap converts your compatible dry bag to a hands-free tote. Adds over-the-shoulder convenience to your waterproof dry bag

### FEATURES

- Simple snap-clip and T-Bar attachment to all Lightweight and Big River series dry bags featuring a base lash point and D-ring
- Comfortable, 3D mesh shoulder pad provides even weight distribution
- Perfect for carrying light loads of up to 15kg to the beach, boat or in tropical downpours

### COLOURS



## DRY BAG SLING

PRODUCT NAME	CODE	SIZE	WEIGHT	COLOUR
Dry Bag Sling	AST041011-050101	ONE SIZE	61g	

# DRY ORGANISATION AND ACCESSORY CASES

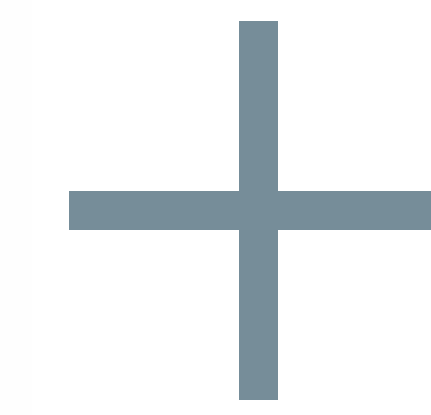

OUR WATER-RESISTANT, DUSTPROOF  
ACCESSORY CASES FEATURE:

**TOUGH**

Totally welded construction

**INDIVIDUALLY TESTED**

Water-resistant and dustproof

**ERGONOMIC DESIGN**

Easy to open, easy to use





# HYDRAULIC PACKING CUBES

Keep gear and clothing organised,  
dust-free and protected



# HYDRAULIC PACKING CUBES **NEW**

Our lightweight and field-ready Hydraulic Packing Cubes keep your gear dust-free, organised and protected in transit and on off-road adventures. With TPU-laminated 70D ripstop nylon, strong RF-welded seams and PU-coated splash-resistant zips—they're engineered to keep the elements out in the toughest conditions.



## HYDRAULIC PACKING CUBE

Keep gear and clothing organised, dust-free and protected with Hydraulic Packing Cubes

### FEATURES

- Built tough and adventure-ready: TPU laminated 70D ripstop nylon
- Dustproof and Splash-resistant: PU-coated zips and RF-welded seams keep the elements out (IP6X Certification for Dust Ingress Protection)
- Easy organisation: Translucent TPU panel allows you to view contents inside
- Lightweight functionality: High-tech materials provide heavy-duty performance with minimal weight
- Convenient handling: Welded hypalon grab-handles for easy handling and secure lashing

SIZES XS / S / M / L / XL





### TPU GUIDE MAP CASE

It's hard to read a wet map—keep yours dry and legible with this waterproof, foldable and durable map case.

#### FEATURES

- Low profile “sandwich bag” closure lets you fold the case into quarters (or smaller) to easily fit into a jacket pocket.

SIZES S / M / L

COLOURS

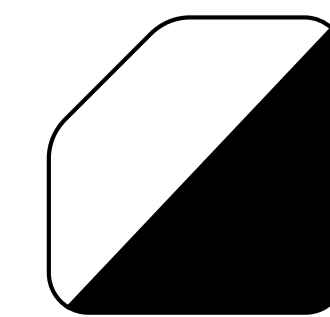

### WATERPROOF MAP CASE

Waterproof protection for your documents no matter the situation.

#### FEATURES

- Watertight roll top closure to keep your map protected from the elements

SIZES S / L

COLOURS

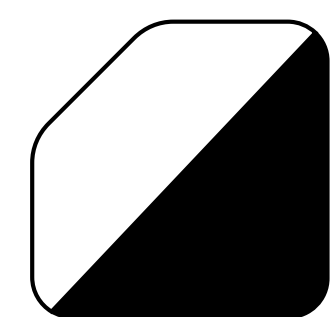

### TPU GUIDE ACCESSORY CASE

Keep your essential accessories dry and accessible.

#### FEATURES

- Meets IPX8 testing standards of being waterproof at 10 metres for one hour
- Touch-screen compatible TPU material allows device to work inside case

SIZES S / M / L

COLOURS

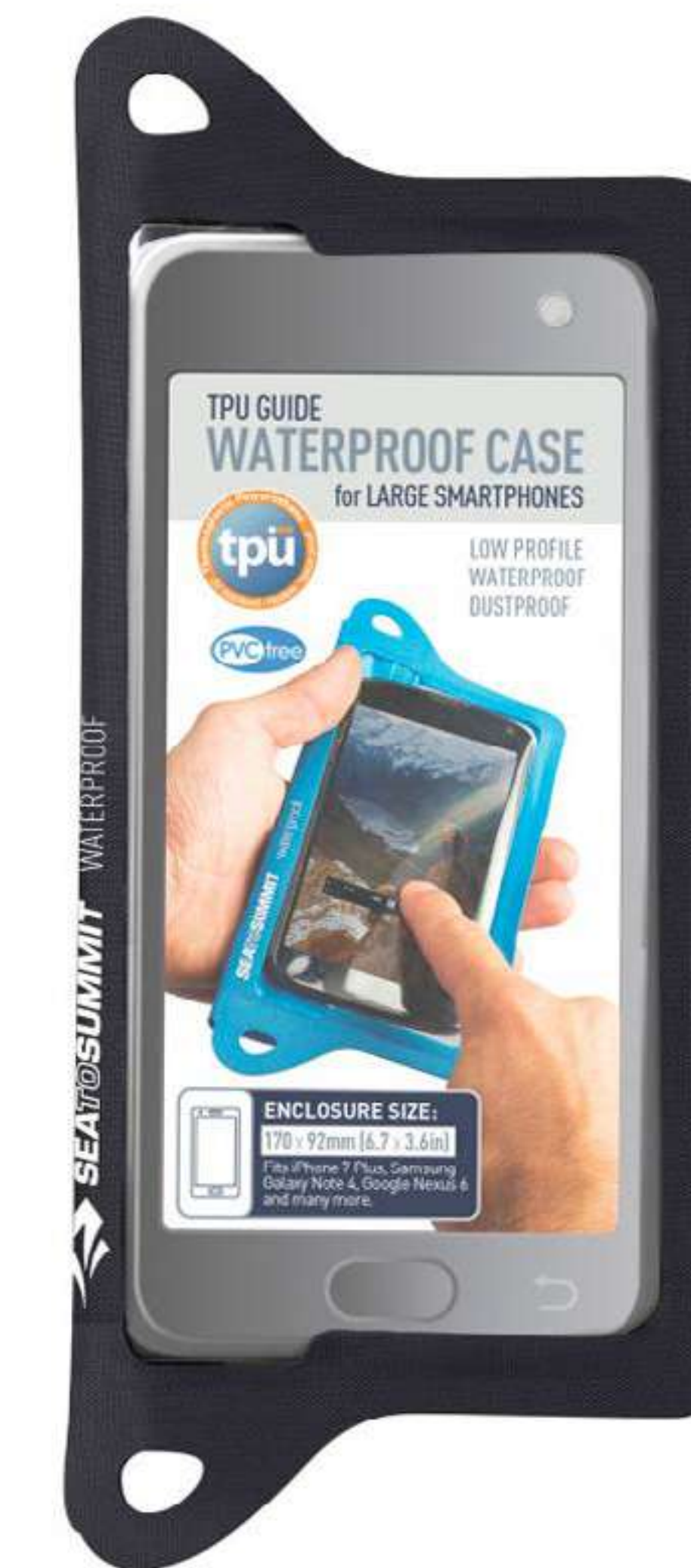
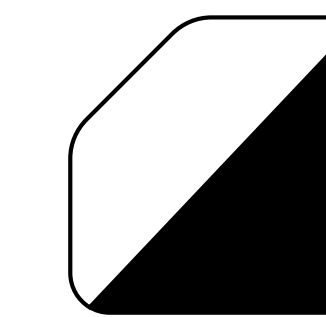

### TPU GUIDE WATERPROOF PHONE CASE

Low-profile, strong and flexible waterproof case for Smartphones.

#### FEATURES

- Meets IPX8 testing standards—waterproof at 10 metres for one hour
- Touch-screen compatible TPU material allows device to work inside case

SIZES R / XL

COLOURS

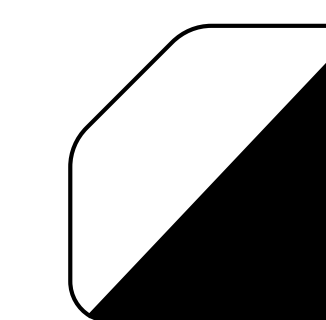

## DRY ORGANISATION AND ACCESSORY CASES

PRODUCT NAME	CODE	SIZE	DIMENSIONS	WEIGHT	COLOUR	RRP
Hydraulic Packing Cube	ASG015121-03	XS	6 x 14.5 x 9.5cm	26.6g		
	ASG015121-04	S	7 x 21 x 11cm	36g		
	ASG015121-05	M	10 x 26.5 x 14cm	62g		
	ASG015121-06	L	10 x 26.5 x 26.5cm	90g		
	ASG015121-07	XL	10 x 26.5 x 35cm	109g		
Hydraulic Packing Cube 3-piece set	ASG015131-12	XS, S, M				
Waterproof Map Case	AWMCS	Small	30 x 22cm	60g		
	AWMCL	Large	33 x 28cm	80g		
TPU Guide Map Case	AMAPTPUS	Small	27.5 x 21cm	56g		
	AMAPTPUM	Medium	30 x 28cm	78g		
	AMAPTPUL	Large	39.5 x 33cm	102g		
TPU Guide Accessory Case	AACTPUSBK	Small	13.5 x 10.5cm	22g		
	AACTPUMBK	Medium	22.5 x 13cm	28g		
	AACTPULBK	Large	21.5 x 15cm	34g		
TPU Guide Waterproof Phone Case	ACTPUSMARTPHBK	Regular	19.5 x 7.5cm	27g		
	ACTPUSPXLBK	XL	23 x 10cm	30g		

# STUFF + COMPRESSION SACKS

Save space and keep your gear organised with our extensive range of mesh sacks, stuff sacks and compression sacks.

## ROBUST MATERIALS

Lightweight yet tough materials for long-lasting reliability.

## STRONG + DURABLE

Double stitched and reinforced seams for greater strength and durability.

## EASY ORGANISATION

Colour coded sizes make it easy to organise your gear sacks.



# STUFF + COMPRESSION SACKS OVERVIEW

UPDATED



UPDATED



UPDATED



UPDATED



UPDATED



PRODUCT	LIGHTWEIGHT COMPRESSION SACK	LIGHTWEIGHT STUFF SACK	ULTRA-SIL COMPRESSION SACK	ULTRA-SIL STUFF SACK	MESH STUFF SACK
	LIGHTWEIGHT		ULTRA-LIGHT		
VOLUME (LITRES)	5 8 13 20 35	3 5 8 13 20 30	5 8 13 20 35	1.5 3 5 8 13 20	1.5 3 5 8 13 20
FABRIC	bluesign® APPROVED 70D PU-Coated traceable recycled nylon, C0 non-PFC DWR finish	bluesign® APPROVED 70D PU-Coated traceable recycled nylon, C0 non-PFC DWR finish	bluesign® APPROVED 30D Ultra-Sil CORDURA® nylon, C0 non-PFC DWR finish	bluesign® APPROVED 30D Ultra-Sil CORDURA® nylon, C0 non-PFC DWR finish	75D Multi-filament Mesh
	<b>70D WATERPROOF FABRIC</b>	<b>70D WATERPROOF FABRIC</b>	<b>30D ULTRA-SIL</b>	<b>30D ULTRA-SIL</b>	
WATERHEAD (MM)	10,000	2000	2000	2000	N/A
BASE	ROUND	ROUND	ROUND	ROUND	ROUND
COLOURS					





# LIGHTWEIGHT COMPRESSION SACK **UPDATED**

Space-saving, lightweight gear storage for organised packing

Pack down your compressible, bulky gear for efficient packing

## FEATURES

- Compress contents down by as much as two thirds
- Lightweight, bluesign® APPROVED traceable recycled 70D nylon main body fabric uses a non-PFC DWR finish
- Side-release buckle compression straps for fast and easy access
- Attached flip-top lid prevents straps tangling

## SIZES

5L / 8L / 13L / 20L / 35L

## COLOURS

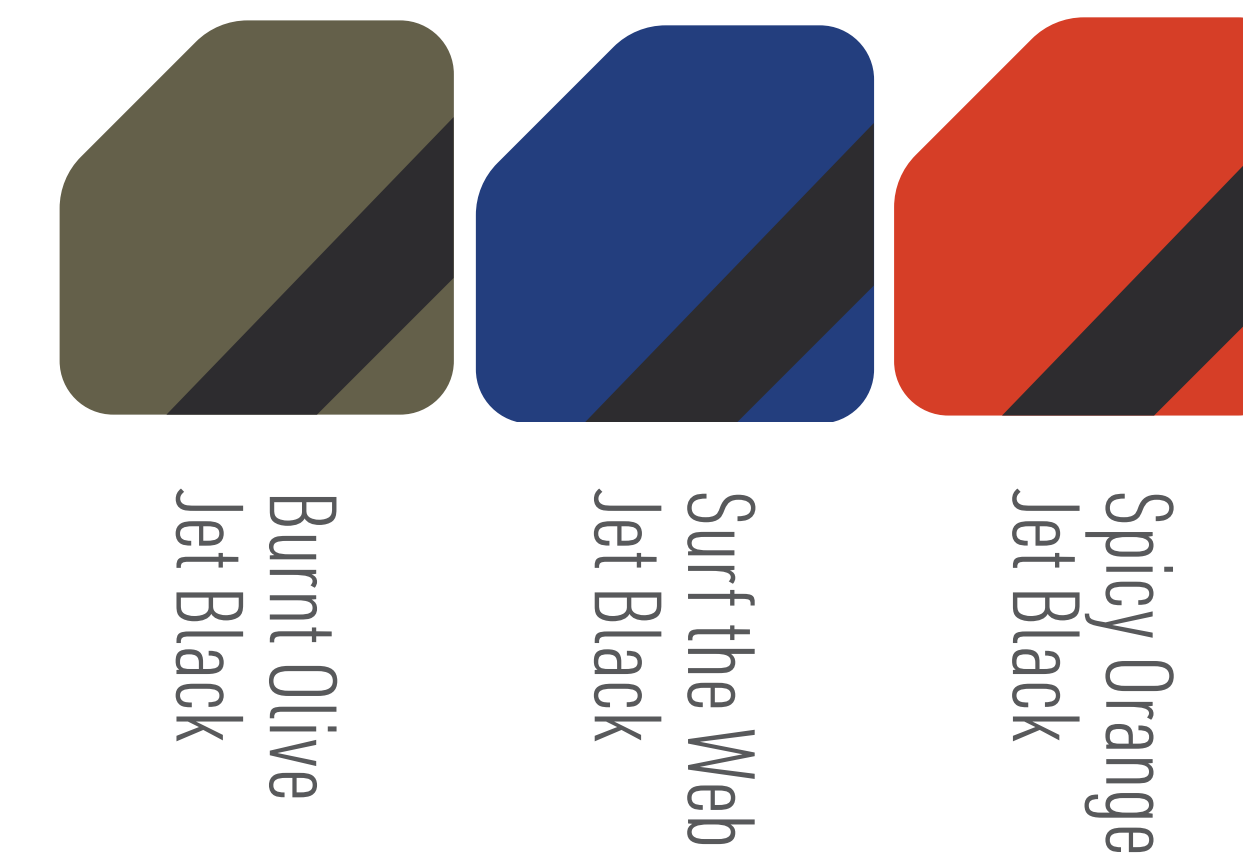

**70D** WATERPROOF FABRIC

**NON PFC**

**SUSTAINABLE DESIGN**

- CO Non-PFC Water Repellent Finish
- 100% RCS Nylon main body fabric
- bluesign® APPROVED main body fabric



# LIGHTWEIGHT STUFF SACK **UPDATED**

Lightweight, durable soft storage for modular packing

Organise and find gear easily



## FEATURES

- Robust, waterproof PU-coated 70D traceable recycled nylon body fabric has a 2,000mm hydrostatic head
- Easy-to-operate opening with durable hypalon pull-tabs on drawcord and throat
- Reinforced stitching on all stress points and overlapped fabric edges for added strength
- Sturdy, nylon webbing handle on round base provides a secure grab point

## SIZES

3L / 5L / 8L / 13L / 20L / 30L

## COLOURS

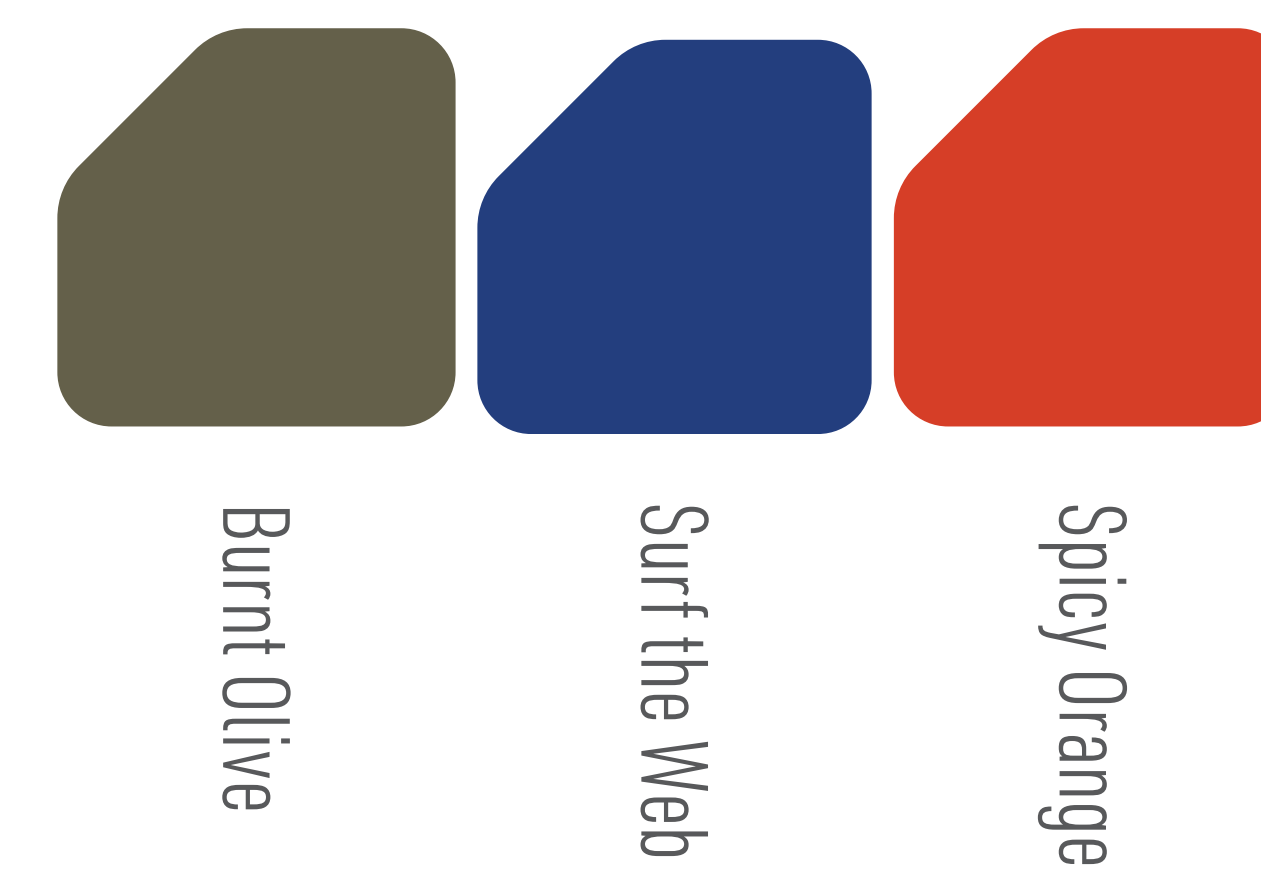

Burnt Olive

Surf the Web

Spicy Orange



**70D WATERPROOF FABRIC**

**NON PFC**

### SUSTAINABLE DESIGN

- CO Non-PFC Water Repellent Finish
- 100% RCS Nylon main body fabric
- bluesign® APPROVED main body fabric



# ULTRA-SIL COMPRESSION SACK **UPDATED**

Space-saving, ultra-lightweight gear storage for organised packing

Pack down your compressible, bulky gear with minimal added weight

## FEATURES

- Compress contents down by as much as two thirds
- Water-resistant, bluesign® APPROVED Ultra-Sil 30D nylon fabric with a CO non-PFC DWR finish
- Side-release buckle compression straps for fast and easy access
- Attached flip-top lid prevents straps tangling

## SIZES

5L / 8L / 13L / 20L / 35L

## COLOURS



**30D ULTRA-SIL**

**NON PFC**



**SUSTAINABLE DESIGN**

- CO Non-PFC Water Repellent Finish
- bluesign® APPROVED main body fabric



# ULTRA-SIL STUFF SACK **UPDATED**

## Ultra-lightweight gear storage for organised packing

Keep your gear organised and easy to pack—with minimal added weight



### FEATURES

- Water-resistant, bluesign® APPROVED Ultra-Sil 30D nylon fabric with a CO non-PFC DWR finish
- Easy-to-operate opening with durable hypalon pull-tabs on drawcord and throat
- Slippery fabric and secure grab handle at base for effortless sliding in and out of packs

### SIZES

1.5L / 3L / 5L / 8L / 13L / 20L

### COLOURS



**30D ULTRA-SIL**

**NON PFC**

**SUSTAINABLE DESIGN**

- CO Non-PFC Water Repellent Finish
- bluesign® APPROVED main body fabric



# MESH STUFF SACK **UPDATED**

## See-through, ultra-lightweight and durable gear storage

Separate and easily identify your gear on-the-go—with minimal added weight

### FEATURES

- Ultra-lightweight and strong 75D multi-filament nylon mesh with a 30D Ultra-Sil drawcord throat for smooth operation
- Easy-to-operate opening with durable hypalon pull-tabs on drawcord and throat
- Double-stitched and reinforced stress points with overlapped fabric edges for added strength and durability
- Minimalist cordlock and drawcord on top closure reduce weight and bulk

### SIZES

1.5L / 3L / 5L / 8L / 13L / 20L

### COLOURS

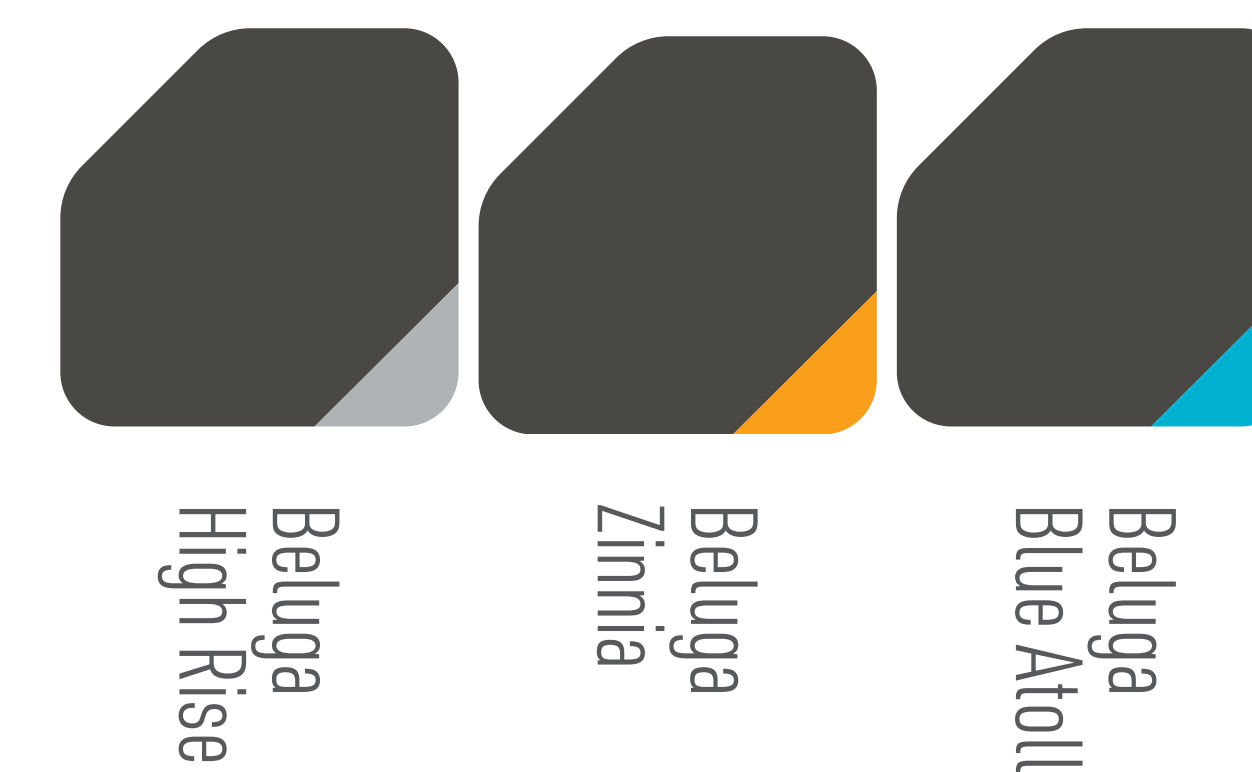



## ULTRA-SIL PEG AND UTENSIL BAG

Protect your equipment and keep sharp-ended gear separate and organised.

### FEATURES

- Reinforced base for durability

### COLOURS

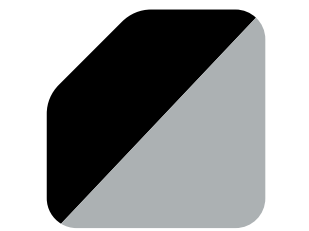



## COMPRESSION SACKS

PRODUCT NAME	CODE	SIZE	DIMENSIONS	WEIGHT	COLOUR	RRP
Lightweight Compression Sack	ASG022011-03	5L	29.6 x 15.2 x 15.2cm	68g		
	ASG022011-04	8L	35.5 x 18.1 x 18.1cm	86g		
	ASG022011-05	13L	43.3 x 20.5 x 20.5cm	112g		
	ASG022011-06	20L	47.5 x 24 x 24cm	134g		
	ASG022011-07	35L	57.8 x 28.8 x 28.8cm	167g		
Ultra-Sil Compression Sack	ASG022021-03	5L	29.6 x 15.2 x 15.2cm	53g		
	ASG022021-04	8L	35.5 x 18.1 x 18.1cm	64g		
	ASG022021-05	13L	43.3 x 20.5 x 20.5cm	82g		
	ASG022021-06	20L	47.5 x 24 x 24cm	96g		
	ASG022021-07	35L	57.8 x 28.8 x 28.8cm	118g		



## STUFF SACKS

PRODUCT NAME	CODE	SIZE	DIMENSIONS	WEIGHT		COLOUR	RRP
Ultra-Sil Stuff Sack	ASG024011-01	1.5L	20.6 x 11.5 x 11.5cm	16g			
	ASG024011-02	3L	23.4 x 13.9 x 13.9cm	20g			
	ASG024011-03	5L	28 x 16.5 x 16.5cm	25g			
	ASG024011-04	8L	32.5 x 19 x 19cm	32g			
	ASG024011-05	13L	37.4 x 21.9 x 21.9cm	44g			
	ASG024011-06	20L	43 x 25 x 25cm	49g			
Ultra-Sil Stuff Sack 3-Piece Set	ASG024041-122101	3, 5, 8L		76g	3L / 5L / 8L		
	ASG024041-122102	5, 8, 13L		100g	5L / 8L / 13L		
Lightweight Stuff Sack	ASG024031-02	3L	23.4 x 13.9 x 13.9cm	29g			
	ASG024031-03	5L	28 x 16.5 x 16.5cm	39g			
	ASG024031-04	8L	32.5 x 19 x 19cm	48g			
	ASG024031-05	13L	37.4 x 21.9 x 21.9cm	60g			
	ASG024031-06	20L	43 x 25 x 25cm	75g			
	ASG024031-07	30L	48.8 x 28.7 x 28.7cm	96g			
	Lightweight Stuff Sack 3-Piece Set	ASG02451-122101	3, 5, 8L	ø11 x 21cm	110g	3L / 5L / 8L	
ASG02451-122102		5, 8, 13L	ø11 x 21cm	147g	5L / 8L / 13L		





## MESH STUFF SACKS

PRODUCT NAME	CODE	SIZE	DIMENSIONS	WEIGHT	TRIM COLOUR	RRP
Mesh Stuff Sack	ASG023011-01	1.5L	20.6 x 11.5 x 11.5cm	22g		
	ASG023011-02	3L	23.4 x 13.9 x 13.9cm	28g		
	ASG023011-03	5L	28 x 16.5 x 16.5cm	36g		
	ASG023011-04	8L	32.5 x 19 x 19cm	44g		
	ASG023011-05	13L	37.4 x 21.9 x 21.9cm	56g		
	ASG023011-06	20L	43 x 25 x 25cm	70g		
Mesh Stuff Sack 3-Piece Set	ASG023041-122101	3, 5, 8L		108g	3L / 5L / 8L	
	ASG023041-122102	5, 8, 13L		136g	5L / 8L / 13L	

## ACCESSORY STUFF SACKS

PRODUCT NAME	CODE	DIMENSIONS	WEIGHT	COLOUR	RRP
Ultra-Sil Peg and Utensil Bag	ABAGPEG	ø10 x 28cm	6g		

**SLEEP**





# SLEEP

## SEA TO SUMMIT: YOUR ONE-STOP SLEEP SYSTEM SHOP

### A RESTED DEVELOPMENT - FROM THE GROUND UP

Sea to Summit innovations in sleeping mats have raised the bar for comfort, ingenuity, ease of use and - above all - reliability.

### VERSATILE SLEEPING BAGS - OPENING UP NEW POSSIBILITIES

Down or synthetic-insulated Comfort and Versatility sleeping bags: unparalleled ventilation, open-flat to form a quilt.

### REDEFINED SLEEPING BAG PACKABILITY

Light and packable sleeping bags feature high lofting down, featherweight shells and liner fabrics for minimal weight and tiny packed volume, yet maximum warmth and comfort.

### NOTHING COMES BETWEEN YOU AND YOUR SEA TO SUMMIT SLEEPING BAG

Except your liner, of course. Multiple options to keep you comfortable and protect your bag. And when you need the perfect pillow, we've got it.



**SLEEPING BAGS**



**LINERS**



**SLEEPING MATS**



**PILLOWS**



**HAMMOCKS**

# SLEEPING BAGS

From ultra light to ultra comfortable, each bag we make is thoughtfully designed and constructed using the finest materials.



# WOMEN'S SPECIFIC SLEEP SYSTEMS

More warmth and room to move for a better sleep outdoors.

Sea to Summit offers the broadest range of women's specific sleeping bags and mats on the market. Designed with more insulation and room to move, these bags and mats are engineered to complement the way women typically sleep, while removing unnecessary weight and bulk.



## WARMTH WHERE IT'S NEEDED

Extra insulation in core zones increases overall warmth, particularly in the areas where women typically feel the cold the most.

## WOMEN'S SPECIFIC FIT

Narrower in the shoulders with more leg and hip room for side sleepers and typical women's body shapes.

**ENGINEERED  
FOR WOMEN**

# DOWN SLEEPING BAGS

Even in this modern day of synthetics, down is still the best insulation for sleeping bags.

It has the best warmth to weight ratio, it is the most durable sleeping bag insulation, and if looked after (and occasionally washed) it will last a lifetime.



# EXPLORE THE RANGE

ULTRA-DRY Down  
850+ Loft

ULTRA-DRY Down  
750+ Loft

ULTRA-DRY Down  
650+ Loft

600+ Loft

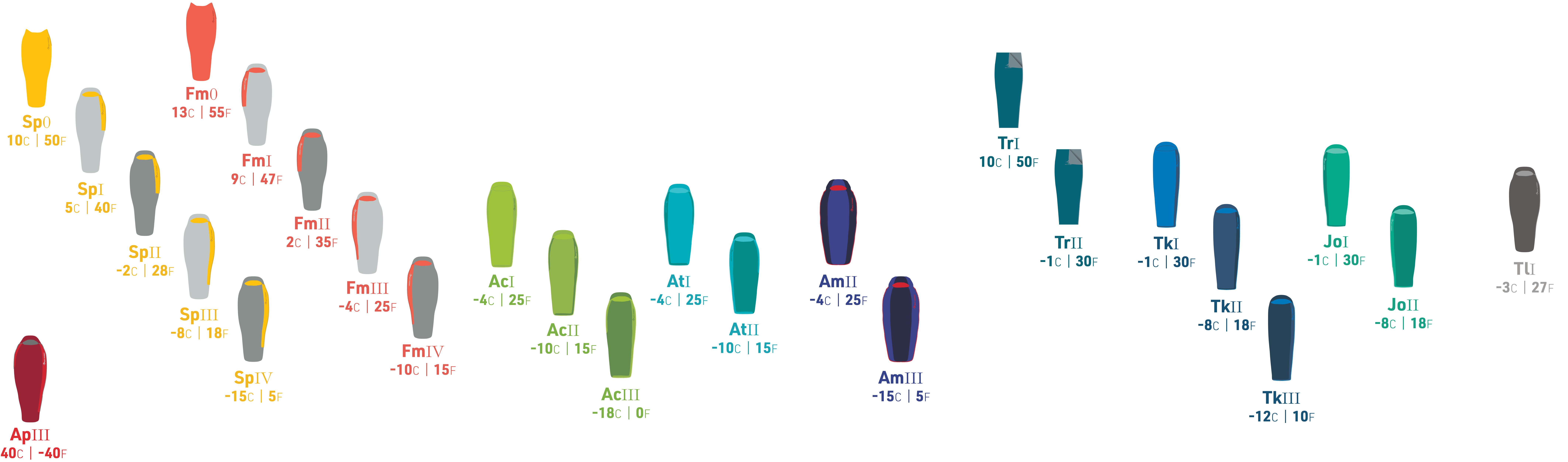
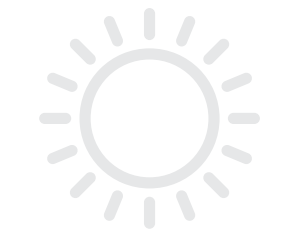



# Alpine Ap



Our first choice for extreme cold and high altitude conditions where sleeping well can make or break an expedition.

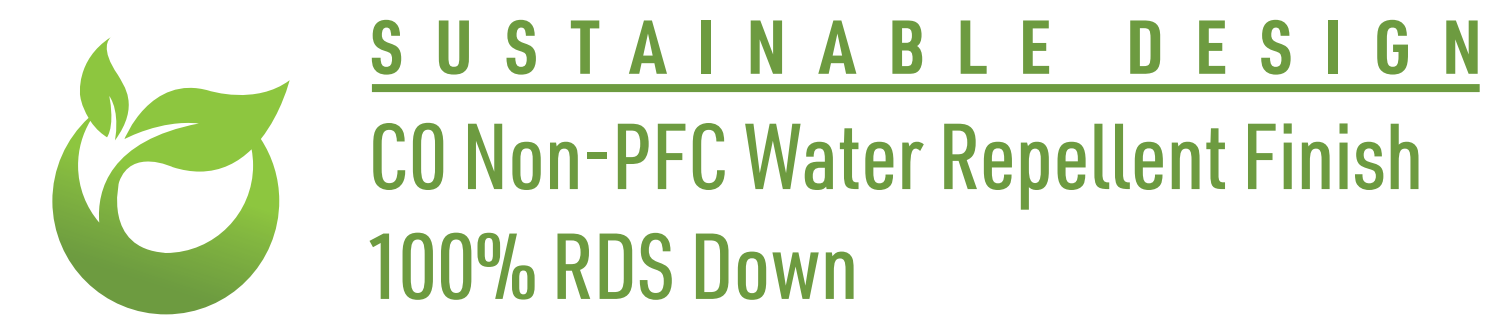





# Alpine Ap

Regular	Long
160cm   63"	168cm   66"
142cm   56"	150cm   59"
131cm   51"	145cm   57"
<183cm   6' MAX USER HEIGHT	<198cm   6'6"

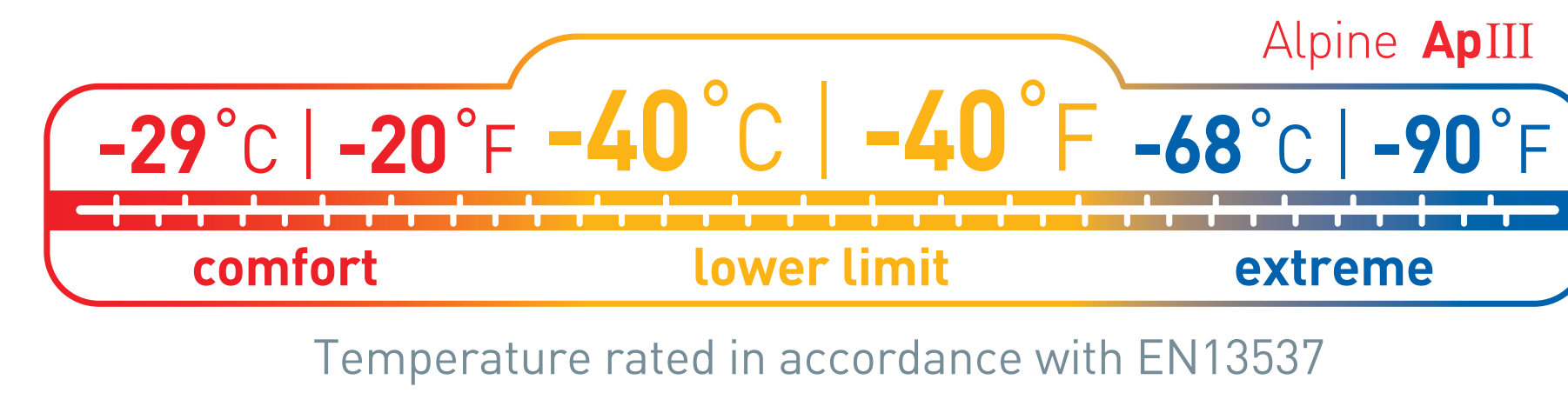
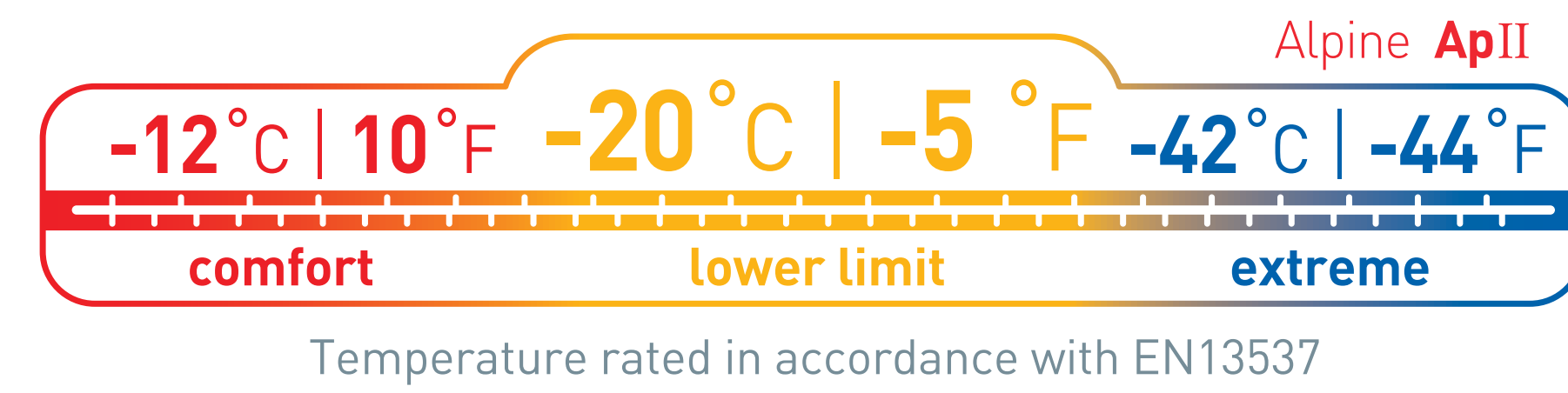
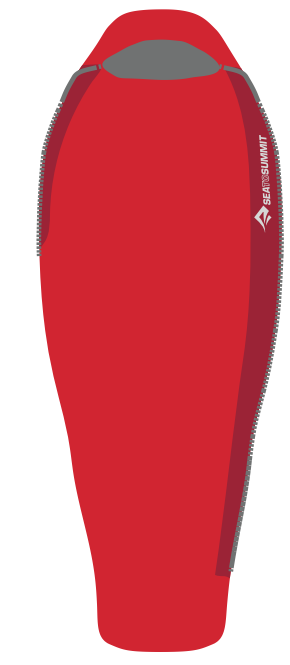

PRODUCT NAME	CODE	SIZE	MAX USER HEIGHT	WEIGHT	FILL WEIGHT	COMPRESSED SIZE	STORAGE	BAFFLE CONSTRUCTION	RRP
Alpine ApII	AAP2-R	Regular	<183 cm	1340g	800g	ø24 x 21cm	L / 20L	Vertical chest baffles, horizontal baffles lower half and base, box wall baffle construction throughout	
	AAP2-L	Long	<198 cm"	1500g	920g	ø24 x 29cm			
Alpine ApIII	AAP3-R	Regular	<183 cm	1870g	1250g	ø27 x 26cm	XL / 30L		
	AAP3-L	Long	<198 cm	2100g	1440g	ø27 x 34cm			

- FABRIC: Waterproof, breathable NanoShell outer fabric
- ZIPS: Full length YKK #5 side zip, two sliders. 1/3 length YKK #5 Free-flow zip.
- PAIRING: This bag is NOT designed to pair with another
- SHAPE: Expedition shaped Mummy
- FOOTBOX: Anatomically shaped and oversized footbox can accommodate boots
- NECK DRAFT TUBE
- SECURITY POCKET





# Spark Sp



The lightest possible shell and liner fabrics, 850+ loftdown and a cut which offers enough room to move: the Spark series packs down into almost impossibly small compression sacks. Five variants cover uses from fast and-light summer excursions to late shoulder-season tours.

ULTRA-DRY Down  
**850+** Loft



**SP0**

FEATURES

- Ideal for mid-summer fast hikes or adventure racing
- Doubles as a liner to significantly boost the warmth of a second bag



**SPI**



**SPII**

FEATURES

- Sizing provides extra room for both shoulders and hips while still maintaining insulation efficiency



**SPIII**



**SPIV**

FEATURES

- Expedition mummy bag sizing provides extra space for layered clothing or extra wriggle room
- Vertical baffles on chest optimises positions of down to prevent it moving during use



**SUSTAINABLE DESIGN**  
CO Non-PFC Water Repellent Finish  
100% RDS Down





# Spark Sp

## SP0

Regular	Long
150cm   59"	158cm   62"
130cm   51"	138cm   54"
88cm   35"	97cm   38"
<183cm   6' MAX USER HEIGHT <198cm   6'6"	



## SPI

Regular	Long
150cm   59"	158cm   62"
130cm   51"	138cm   54"
88cm   35"	97cm   38"
<183cm   6' MAX USER HEIGHT <198cm   6'6"	

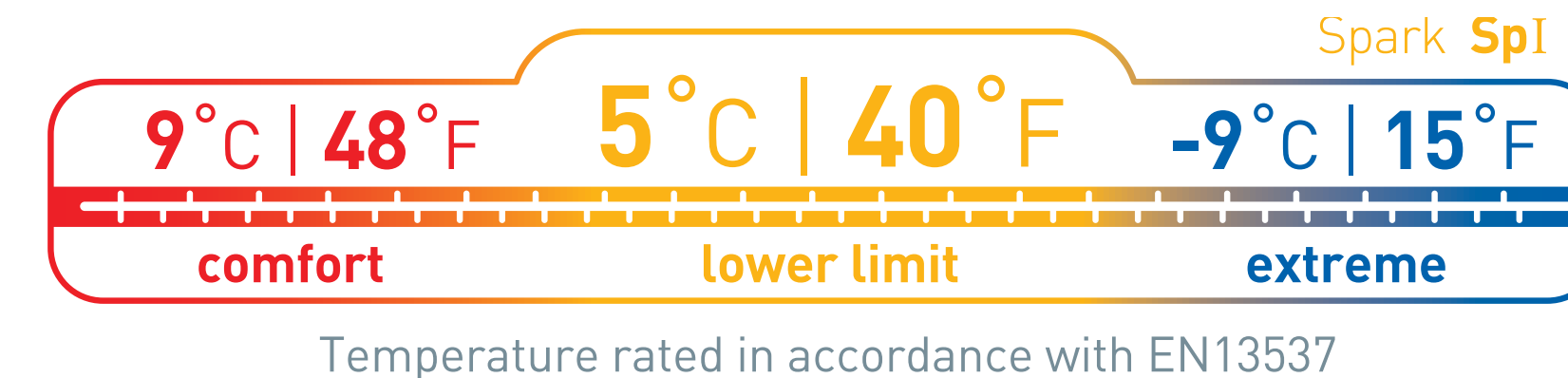
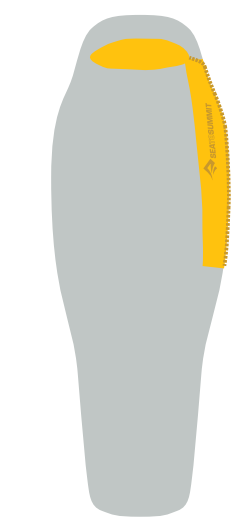

## SPII

Regular	Long
150cm   59"	158cm   62"
130cm   51"	138cm   54"
88cm   35"	97cm   38"
<183cm   6' MAX USER HEIGHT <198cm   6'6"	

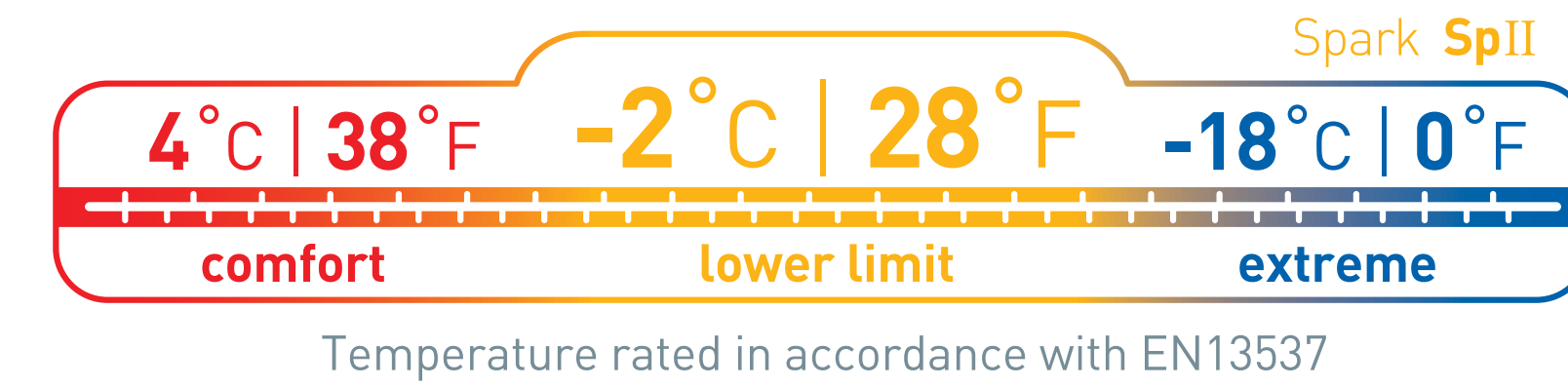

## SPIII

Regular	Long
155cm   61"	162cm   64"
135cm   53"	142cm   56"
94cm   37"	100cm   39"
<183cm   6' MAX USER HEIGHT <198cm   6'6"	

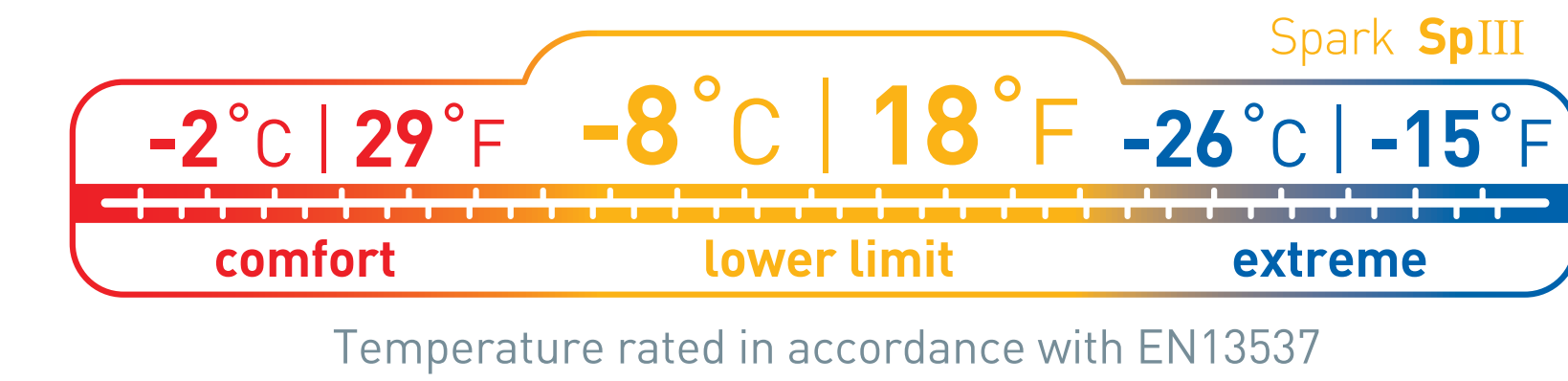

## SPIV

Regular	Long
155cm   61"	162cm   64"
135cm   53"	142cm   56"
94cm   37"	100cm   39"
<183cm   6' MAX USER HEIGHT <198cm   6'6"	

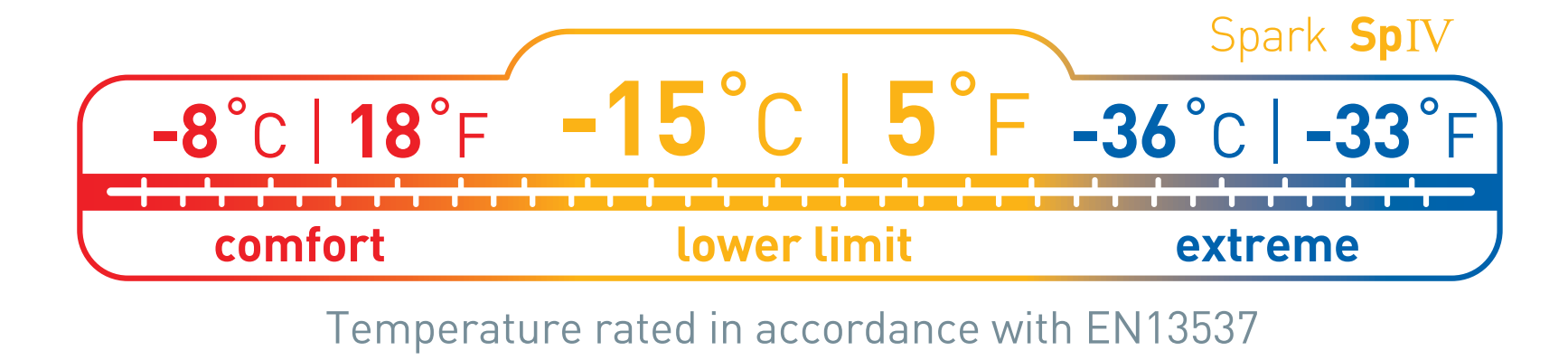
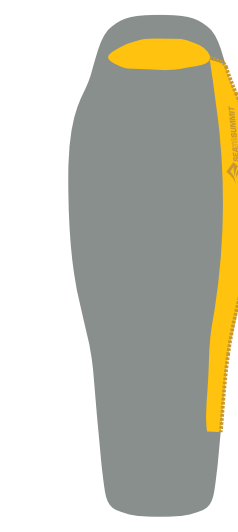

PRODUCT NAME	CODE	SIZE	WEIGHT	FILL WEIGHT	COMPRESSED SIZE	STORAGE	BAFFLE CONSTRUCTION	RRP
Spark Sp0	ASP0-R	Regular	225g	100g	ø9.5 x 18cm   0.9L	Integrated stuff sack (uncompressed dimensions)	Narrow horizontal baffles, sewn through quilted construction throughout	
	ASP0-L	Long	260g	115g	ø10.5 x 20cm   1.3L			
Spark SpI	ASP1-R	Regular	340g	180g	ø11.5 x 14cm   1.5L	3XS / 2.5L	Vertical chest baffles, horizontal baffles lower half and base, sewn through quilted construction throughout	
	ASP1-L	Long	385g	205g	ø11.5 x 21cm   2.2L			
Spark SpII	ASP2-R	Regular	490g	300g	ø13 x 19cm   2.5L	2XS / 3.3L	Vertical chest baffles, horizontal baffles lower half and base, box wall baffles top half of bag and sewn through quilted construction lower half	
	ASP2-L	Long	560g	345g	ø15.5 x 19cm   3.5L			
Spark SpIII	ASP3-R	Regular	665g	430g	ø15.5 x 24cm   4.6L	XS / 6L	Vertical chest baffles, horizontal baffles lower half and base, box wall baffle construction throughout	
	ASP3-L	Long	745g	485g	ø15.5 x 29cm   5.4L			
Spark SpIV	ASP4-R	Regular	880g	620g	ø18.5 x 25cm   6.6L	S / 10L		
	ASP4-L	Long	985g	700g	ø18.5 x 29cm   7.7L			

DESIGNED FOR	Unisex design
ZIPS	Sp 0-II: Light gauge YKK #3 Sp III-IV: YKK #5
PAIRING	These bags are NOT designed to pair with another
SHAPE	Sp 0-II: Contoured Mummy Sp III-IV: Expedition Mummy
NECK DRAFT TUBE	Sp 0-I: <input type="checkbox"/> Sp II-IV: <input checked="" type="checkbox"/>
SECURITY POCKET	<input type="checkbox"/>



# Flame Fm



The Flame series is perfect for women adventurers who need the lightest and most packable sleep system. Incredibly light shell and liner materials and high-lofting down are matched with meticulous construction in a range of five separate ultralight bags.

**ENGINEERED FOR WOMEN**

ULTRA-DRY Down  
**850+** Loft



**FM0**

FEATURES

- Ideal for mid-summer fast hikes or adventure racing
- Doubles as a liner to significantly boost the warmth of a second bag

**SUSTAINABLE DESIGN**  
CO Non-PFC Water Repellent Finish  
100% RDS Down

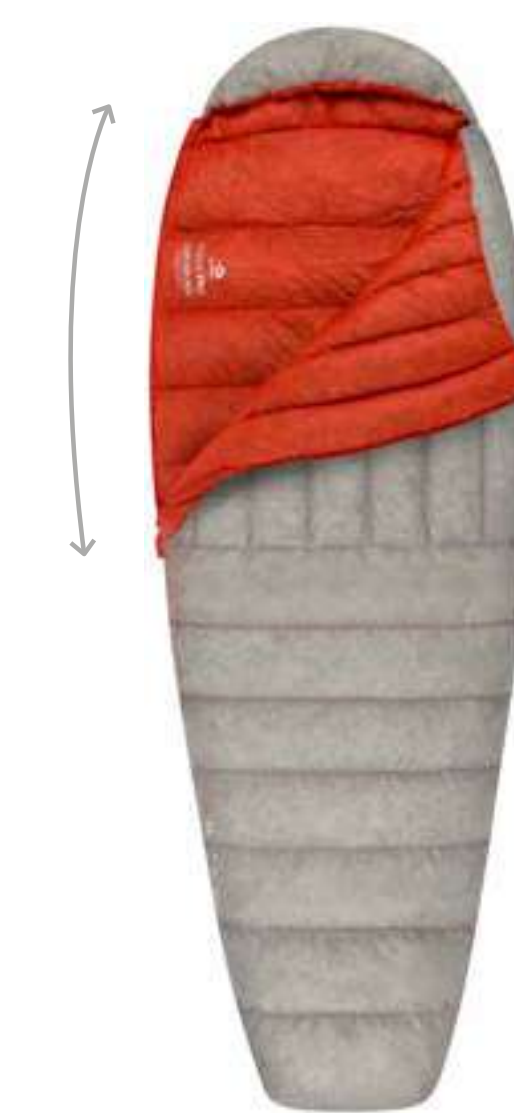

**FMI**



**FMII**

FEATURES

- Lower part of the bag uses a sewn through horizontal baffle construction to minimise weight
- Includes hood draft collar



**FMIII**



**FMIV**

FEATURES

- Full side zip with two sliders provides easy access and extra ventilation options





# Flame Fm

## FM0

Regular	Long
146cm   57"	152cm   58"
136cm   53"	142cm   56"
88cm   35"	94cm   38"
<183cm   6' MAX USER HEIGHT <198cm   6'6"	

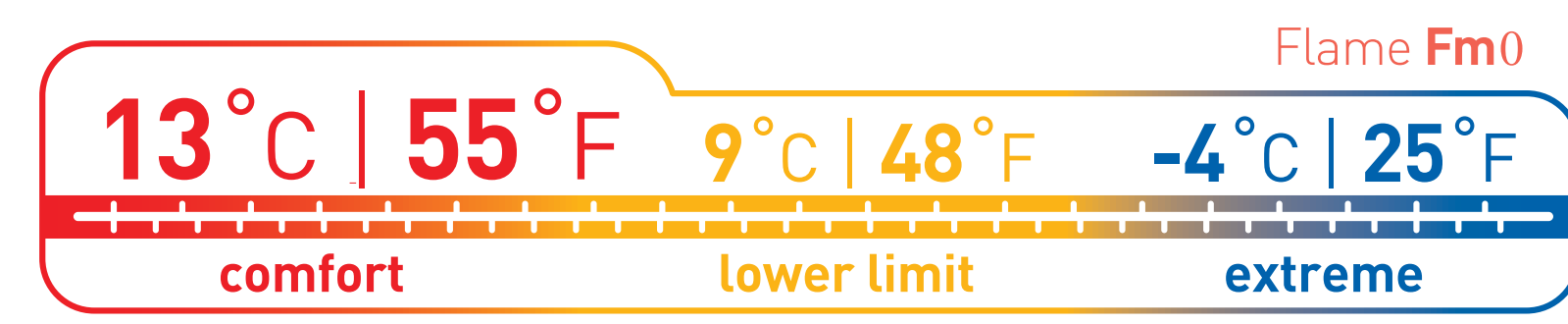

Temperature rated in accordance with EN13537

## FM1

Regular	Long
146cm   57"	152cm   58"
136cm   53"	142cm   56"
88cm   35"	94cm   38"
<183cm   6' MAX USER HEIGHT <198cm   6'6"	

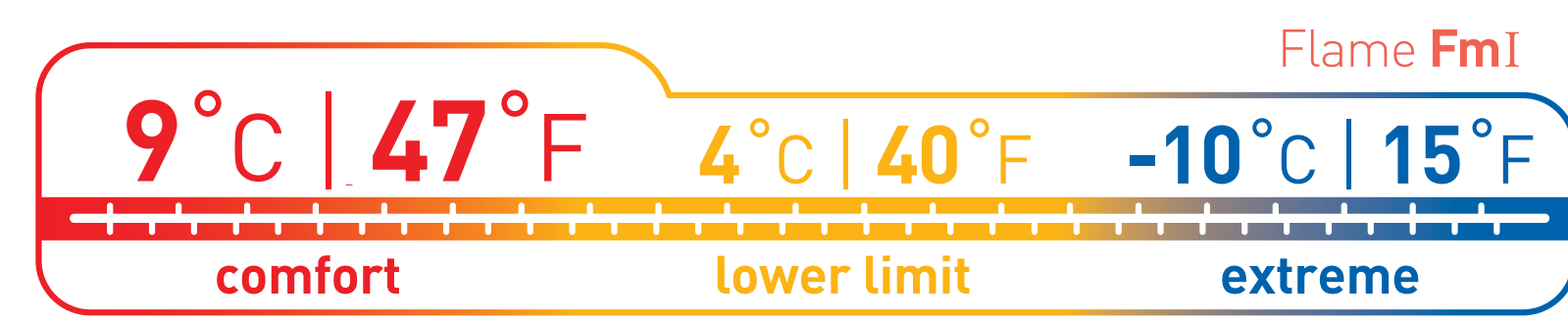
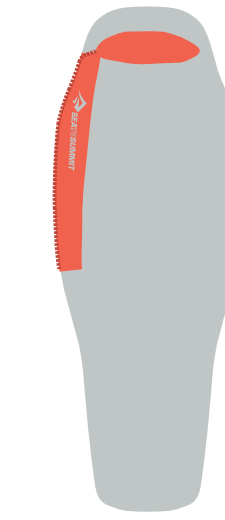

Temperature rated in accordance with EN13537

## FMII

Regular	Long
146cm   57"	152cm   58"
136cm   53"	142cm   56"
88cm   35"	94cm   38"
<183cm   6' MAX USER HEIGHT <198cm   6'6"	

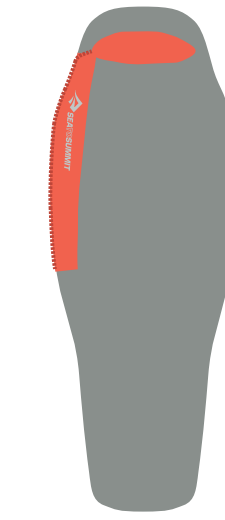

Temperature rated in accordance with EN13537

## FMIII

Regular	Long
150cm   59"	155cm   61"
142cm   56"	148cm   58"
90cm   36"	96cm   38"
<183cm   6' MAX USER HEIGHT <198cm   6'6"	

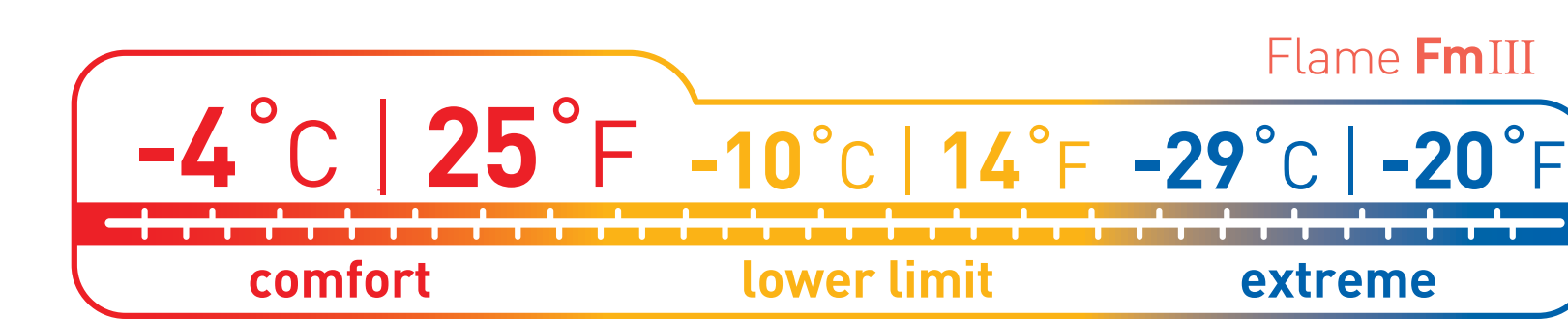
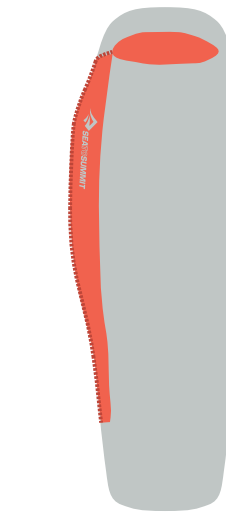

Temperature rated in accordance with EN13537

## FMIV

Regular	Long
150cm   59"	155cm   61"
142cm   56"	148cm   58"
90cm   36"	96cm   38"
<183cm   6' MAX USER HEIGHT <198cm   6'6"	

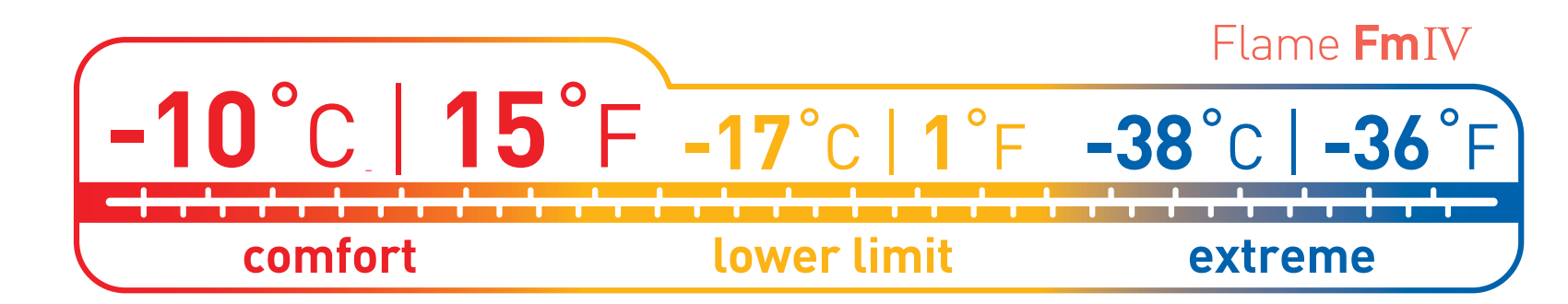
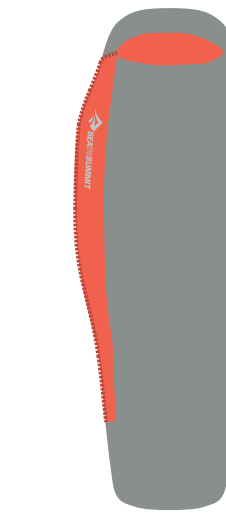

Temperature rated in accordance with EN13537

PRODUCT NAME	CODE	SIZE	WEIGHT	FILL WEIGHT	COMPRESSED SIZE	STORAGE	BAFFLE CONSTRUCTION	RRP
Flame Fm0	AFM0-WR	Regular	215g	100g	ø9.5 x 16cm   0.7L	Integrated stuff sack (uncompressed dimensions)	Narrow horizontal baffles, sewn through quilted construction throughout	
	AFM0-WL	Long	250g	115g	ø10.5 x 18cm   1.1L			
Flame FmI	AFM1-WR	Regular	350g	190g	ø11.5 x 15cm   1.6L	3XS / 2.5L	Vertical chest baffles, horizontal baffles lower half and base, sewn through quilted construction throughout	
	AFM1-WL	Long	395g	215g	ø11.5 x 21cm   2.2L			
Flame FmII	AFM2-WR	Regular	505g	310g	ø13 x 22cm   2.9L	2XS / 3.3L	Vertical chest baffles, horizontal baffles lower half and base, box wall baffles top half of bag and sewn through quilted construction lower half	
	AFM2-WL	Long	575g	355g	ø15.5 x 20cm   3.8L			
Flame FmIII	AFM3-WR	Regular	665g	440g	ø15.5 x 28cm   5.3L	XS / 6L		
	AFM3-WL	Long	745g	495g	ø18.5 x 23cm   6.3L			
Flame FmIV	AFM4-WR	Regular	890g	650g	ø18.5 x 26cm   7.1L	S / 10L	Vertical chest baffles, horizontal baffles lower half and base, box wall baffle construction throughout	
	AFM4-WL	Long	995g	730g	ø18.5 x 29cm   7.9L			

DESIGNED FOR	Women's specific design
ZIPS	Fm 0-II: Light gauge YKK #3 Fm III-IV: YKK #5
PAIRING	These bags are NOT designed to pair with another
SHAPE	Fm 0-II: Contoured Mummy Fm III-IV: Expedition Mummy
NECK DRAFT TUBE	Sp 0-I: <input type="checkbox"/> Sp II-IV: <input checked="" type="checkbox"/>
SECURITY POCKET	<input type="checkbox"/>



# Ascent Ac



Offering the perfect backpacking balance of comfort vs weight, our Ascent Series sleeping bags have more space than traditional mummy bags, yet still provide the thermal efficiency you need when exploring above the tree-line.



**SUSTAINABLE DESIGN**  
CO Non-PFC Water Repellent Finish  
100% RDS Down



# Altitude At



Engineered for women to provide extra warmth where needed, be prepared for the unpredictable with our adaptable Altitude Series bags.

**ENGINEERED FOR WOMEN**

**THERMOLITE**

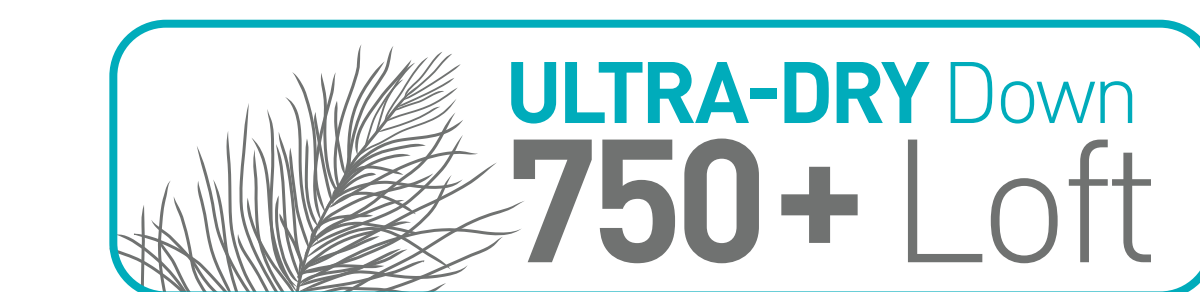

**SUSTAINABLE DESIGN**  
CO Non-PFC Water Repellent Finish  
100% RDS Down





# Ascent Ac

Regular	Long
155cm   61"	165cm   65"
146cm   57"	156cm   61"
122cm   48"	129cm   51"
<183cm   6' MAX USER HEIGHT	<198cm   6'6"

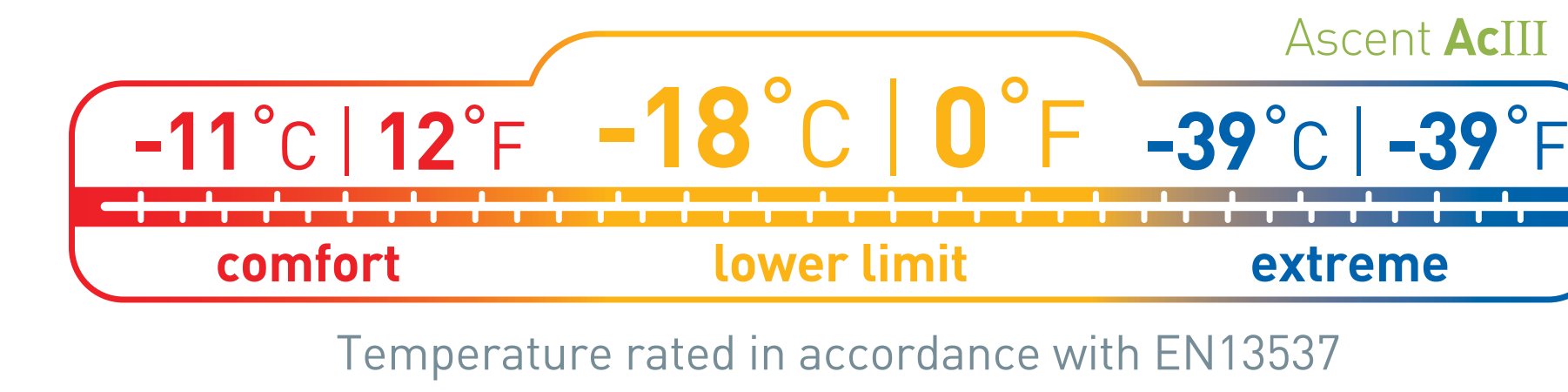
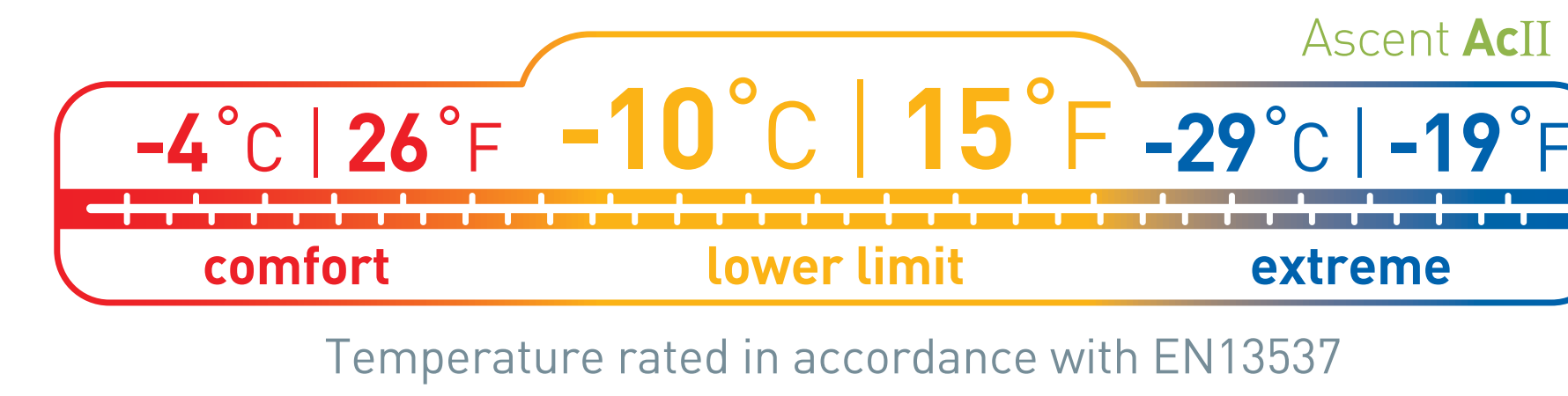
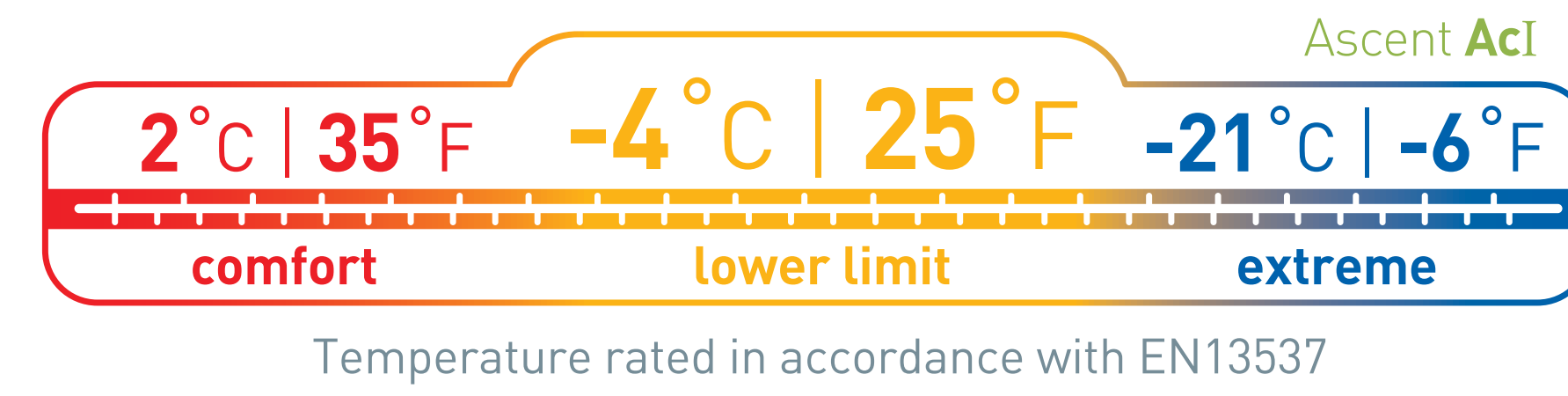
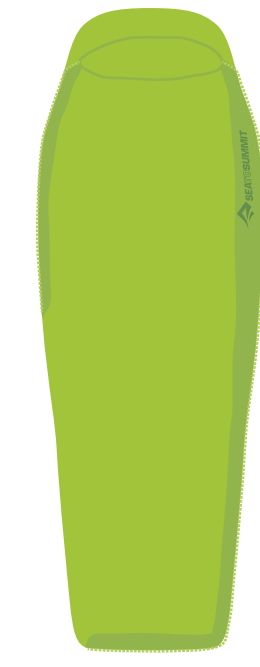

PRODUCT NAME	CODE	SIZE	MAX USER HEIGHT	WEIGHT	FILL WEIGHT	COMPRESSED SIZE	STORAGE	BAFFLE CONSTRUCTION	RRP
Ascent AcI	AAC1-R	Regular	< 183 cm	860g	330g	ø18.5 x 18cm   4.9L	S / 10L Ultra-Sil Compression	Vertical chest baffles, horizontal baffles lower half and base, box wall baffle construction throughout	
	AAC1-L	Long	< 198 cm	930g	370g	ø18.5 x 24cm   6.4L			
Ascent AcII	AAC2-R	Regular	< 183 cm	1100g	550g	ø18.5 x 23cm   6.2L	M / 14L Ultra-Sil Compression		
	AAC2-L	Long	< 198 cm	1195g	615g	ø21 x 23cm   7.8L			
Ascent AcIII	AAC3-R	Regular	< 183 cm	1325g	750g	ø21 x 24cm   8.2L			
	AAC3-L	Long	< 198 cm	1445g	840g	ø21 x 29cm   10.2L			

- DESIGNED FOR: Unisex design
- ZIPS: YKK #5 Double sliders
- PAIRING: This bag IS designed to pair with another
- SHAPE: Tapered rectangular
- NECK DRAFT TUBE
- SECURITY POCKET





# Altitude At

Regular	Long
148cm   58"	152cm   60"
148cm   58"	152cm   60"
118cm   46"	122cm   48"
<183cm   6' MAX USER HEIGHT	<198cm   6'6"

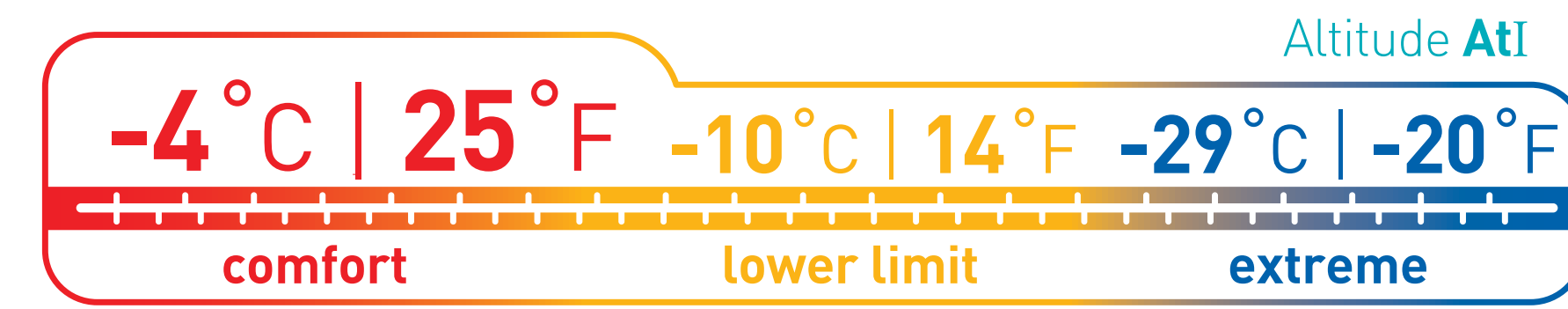
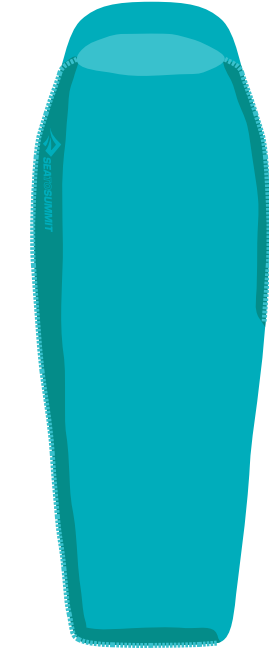

Temperature rated in accordance with EN13537

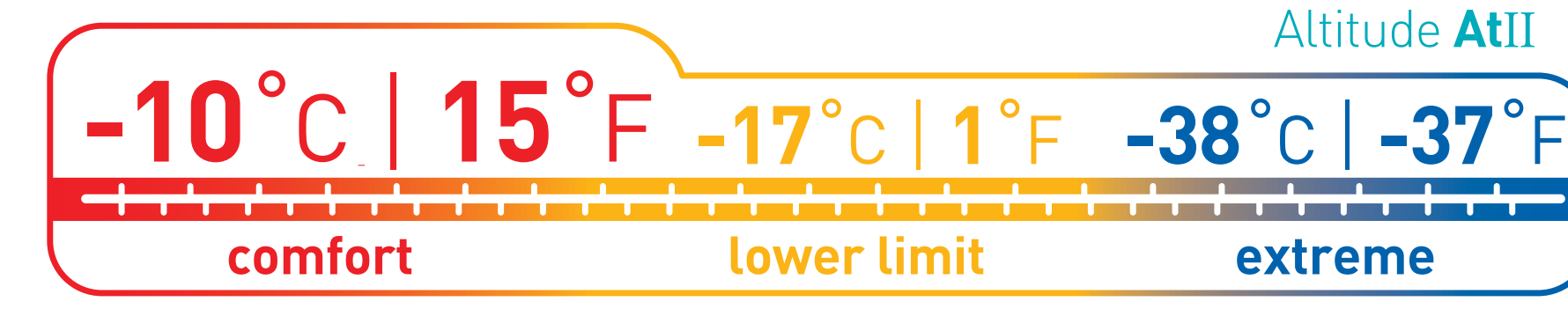

Temperature rated in accordance with EN13537

PRODUCT NAME	CODE	SIZE	MAX USER HEIGHT	WEIGHT	FILL WEIGHT	COMPRESSED SIZE	STORAGE	BAFFLE CONSTRUCTION	RRP
Altitude AtI	AAT1-WR	Regular	< 170 cm	1080g	520g	ø18.5 x 24cm   6.5L	S / 10L Ultra-Sil Compression	Vertical chest baffles, horizontal baffles lower half and base, box wall baffle construction throughout	
	AAT1-WL	Long	< 183cm	1170g	580g	ø18.5 x 31cm   8.3L			
Altitude AtII	AAT2-WR	Regular	< 170 cm	1280g	720g	ø21 x 23cm   8.1L	M / 14L Ultra-Sil Compression		
	AAT2-WL	Long	< 183cm	1390g	800g	ø21 x 28cm   9.8L			

- DESIGNED FOR: Women's specific design
- FEATURES: Extra down overall, THERMOLITE® panels in foot area
- ZIPS: YKK #5 Double sliders
- PAIRING: This bag IS designed to pair with another
- SHAPE: Tapered rectangular
- NECK DRAFT TUBE:
- SECURITY POCKET:





# Amplitude Am



Comfort and versatility for long trips when shaving weight is not your highest priority.

The Amplitude is ideal for outdoor adventures that return to the same camp site each evening, for car camping road trips, crag-hopping van life or hut-based expeditions.

**ZIP COUPLING**  
BAGS ZIP TOGETHER

**ULTRA-DRY** Down  
**750+** Loft

**SUSTAINABLE DESIGN**  
CO Non-PFC Water Repellent Finish  
100% RDS Down



# Traveller Tr



Small and light yet warm and lofty 750+ down, the Traveller is your couch-surfing comrade.

The ultimate choice for your Camino pilgrimage, round-the-world adventure or keeping warm on a plane.

**ZIP COUPLING**  
BAGS ZIP TOGETHER

**ULTRA-DRY** Down  
**750+** Loft

**SUSTAINABLE DESIGN**  
CO Non-PFC Water Repellent Finish  
100% RDS Down



VIDEO



# Amplitude Am

Regular	Long
194cm   76"	208cm   82"
190cm   75"	204cm   80"
142cm   56"	172cm   68"
<183cm   6'	<198cm   6'6"

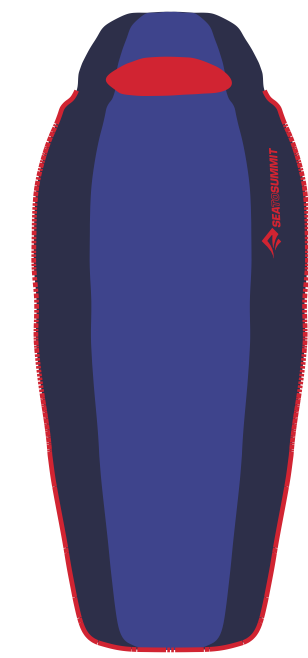

MAX USER HEIGHT

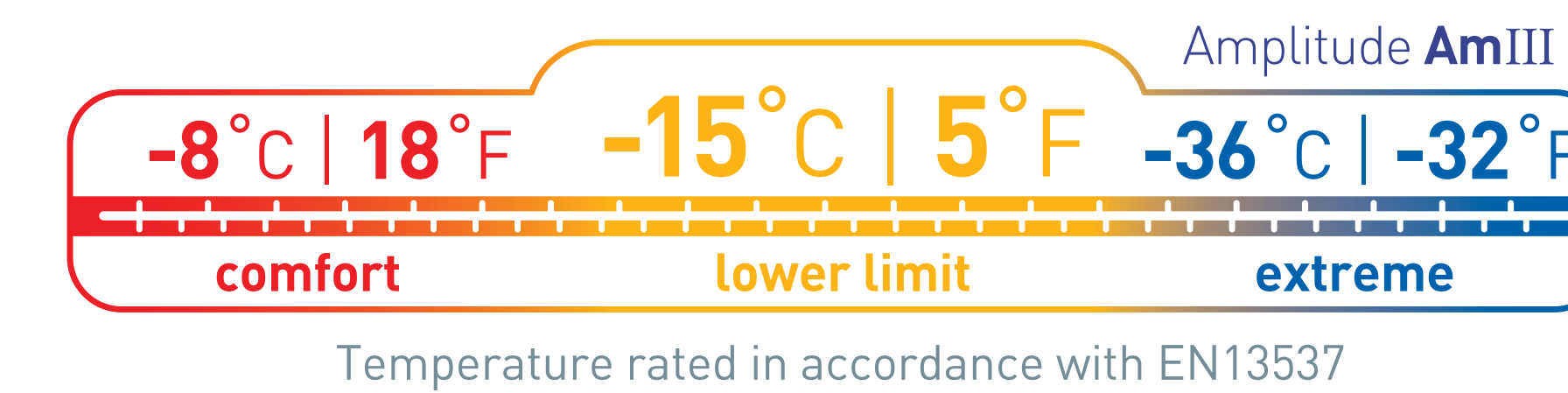
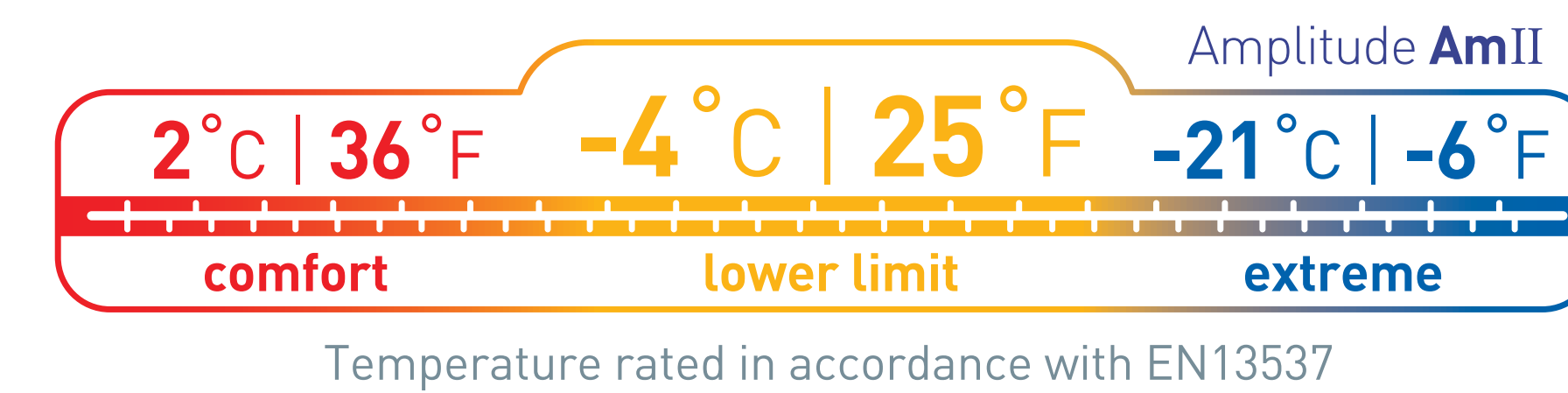

PRODUCT NAME	CODE	SIZE	MAX USER HEIGHT	WEIGHT	FILL WEIGHT	COMPRESSED SIZE	STORAGE	BAFFLE CONSTRUCTION	RRP
Amplitude AmII	AMP2-R	Regular	< 183 cm	1095g	450g	ø18.5 x 23cm   6.3L	S / 10L	Vertical chest baffles, horizontal baffles lower half and base, box wall baffle construction throughout	
	AMP2-L	Long	< 198 cm	1205g	520g	ø18.5 x 30cm   8L			
Amplitude AmIII	AMP3-R	Regular	< 183 cm	1395g	750g	ø21 x 30cm   10.4L	M / 14L		
	AMP3-L	Long	< 198 cm	1595g	860g	ø21 x 36cm   12.3L			

- DESIGNED FOR: Unisex design
- ZIPS: Full length YKK #5 side zips with two sliders on both sides of bag. YKK #5 foot opening zip
- MULTI-ZIP: Multi-zip configuration converts bag to a standalone quilt for warmer conditions
- PAIRING: This bag IS designed to pair with another
- FEATURES: Adjustable webbing loop system connects sleeping mat to bag
- SHAPE: Spacious contoured rectangle
- NECK DRAFT TUBE:
- SECURITY POCKET:



# Traveller Tr

## TRI

Regular	Long
148cm   58"	168cm   66"
134cm   53"	154cm   61"
98cm   39"	118cm   46"
<183cm   6' MAX USER HEIGHT	<198cm   6'6"

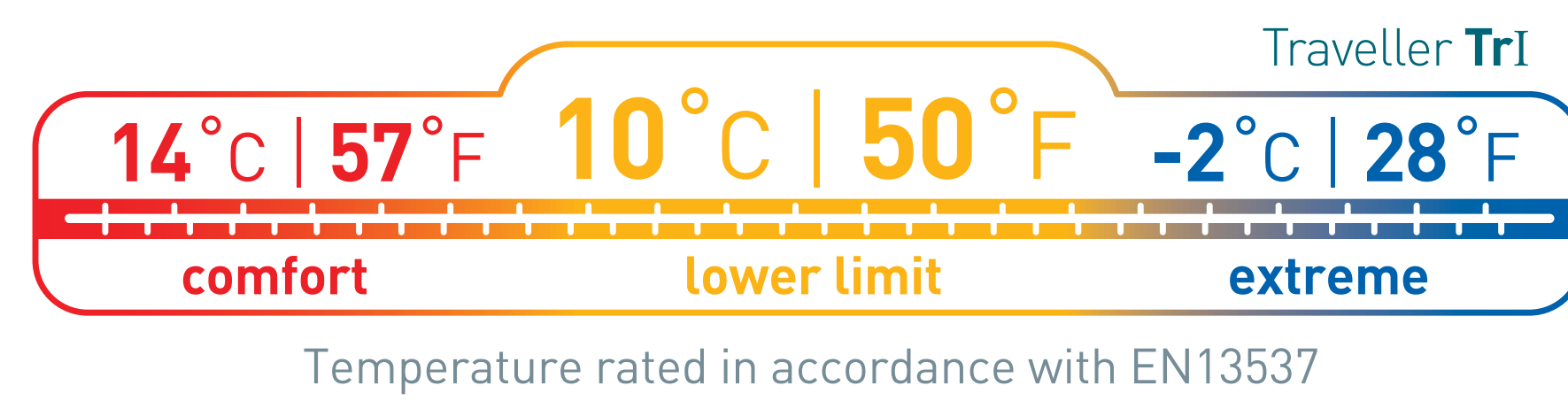

## TRII

Regular	Long
155cm   61"	168cm   66"
141cm   55"	154cm   61"
105cm   41"	118cm   46"
<183cm   6' MAX USER HEIGHT	<198cm   6'6"



PRODUCT NAME	CODE	SIZE	MAX USER HEIGHT	WEIGHT	FILL WEIGHT	COMPRESSED SIZE	STORAGE	BAFFLE CONSTRUCTION	RRP
Traveller Tri	ATR1-R	Regular	< 183 cm	420g	200g	ø11.5 x 15cm   1.6L	3XS / 2.5L	Box quilted sewn through baffles	
	ATR1-L	Long	< 198 cm	500g	240g	ø13 x 18cm   2.4L	2XS / 3.3L		
Traveller TriI	ATR2-R	Regular	< 183 cm	645g	350g	ø15.5 x 24cm   4.5L	XS / 6L	Narrow horizontal box wall baffles	
	ATR2-L	Long	< 198 cm	755g	420g	ø18 x 23cm   5.8L	S / 10L		

- DESIGNED FOR: Unisex design
- ZIPS: Full length YKK #3 side zip, two sliders
- PAIRING: This bag IS designed to pair ONLY with another Traveller
- SHAPE: Tapered rectangular / quilt
- FEATURES: Shoulder and foot drawcords cinch the bag tight to retain maximum warmth
- NECK DRAFT TUBE:
- SECURITY POCKET:



# Trek TK



For campers, travelers and occasional backpackers, the Trek series offers more room and ventilation than a conventional mummy-shaped sleeping bag.

These light, compressible sleeping bags can be cinched down in colder conditions or opened up to form a full-flat quilt in warmer weather: flexibility which makes them ideal long-distance traveling companions.

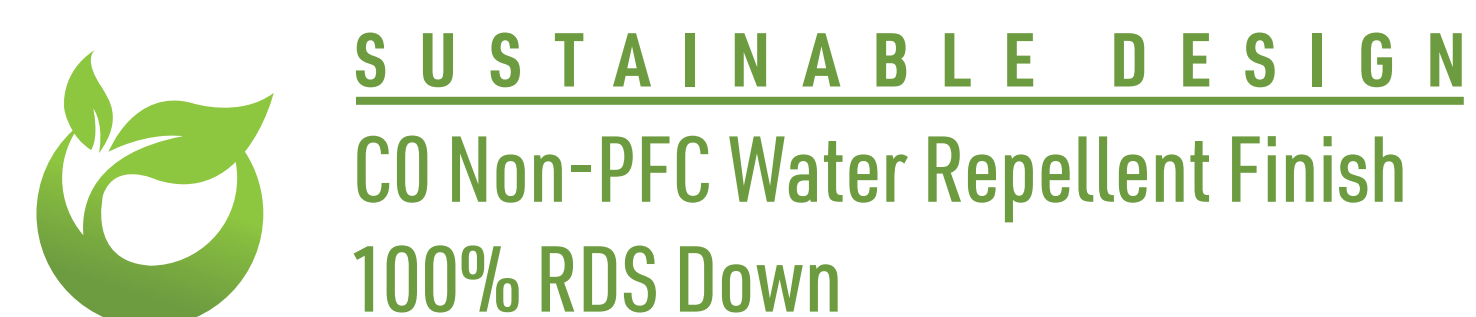

# Journey Jo



The Journey is the ideal women's specific sleeping bag for a variety of pursuits, from backpacking to travel to car-camping across multiple seasons.

Thermolite insulation in the footbox and extra down throughout keeps women sleepers warm, while the side and footbox zippers can be opened up for ventilation when the mercury climbs.

ENGINEERED FOR WOMEN

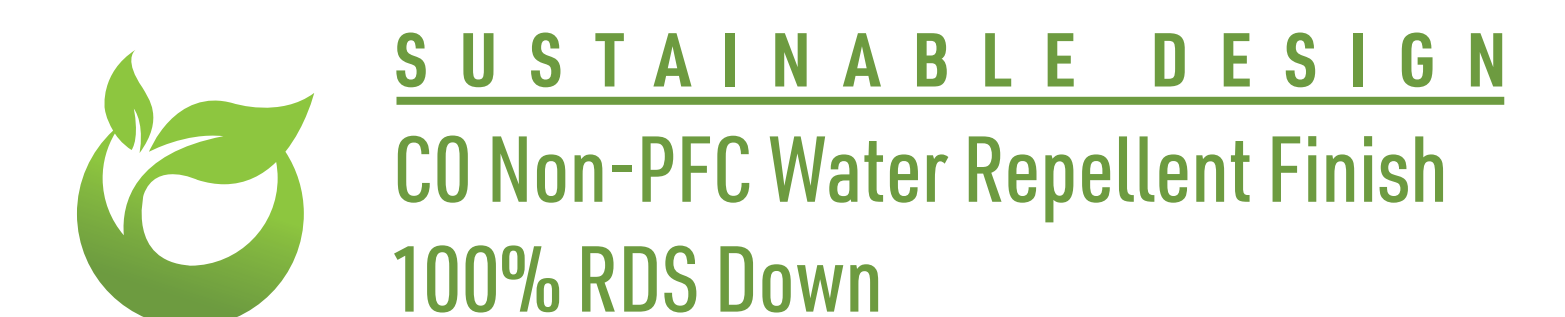



# Trek Tk

Regular	Reg Wide	Long
152cm   60"	172cm   68"	162cm   64"
146cm   57"	161cm   63"	157cm   62"
102cm   40"	122cm   48"	108cm   43"
<183cm   6'	<183cm   6' MAX USER HEIGHT	<198cm   6'6"

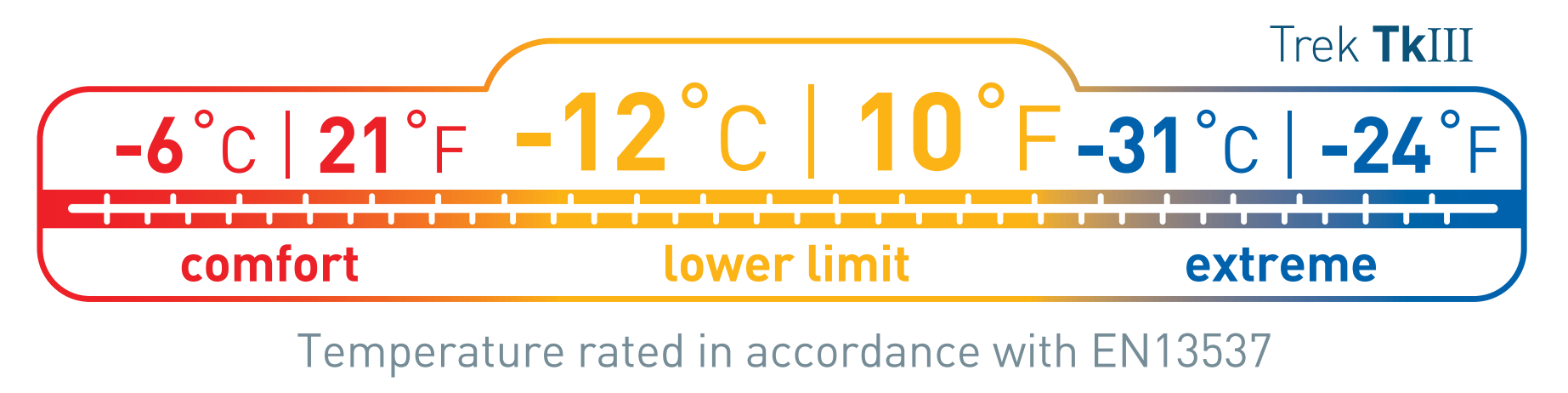
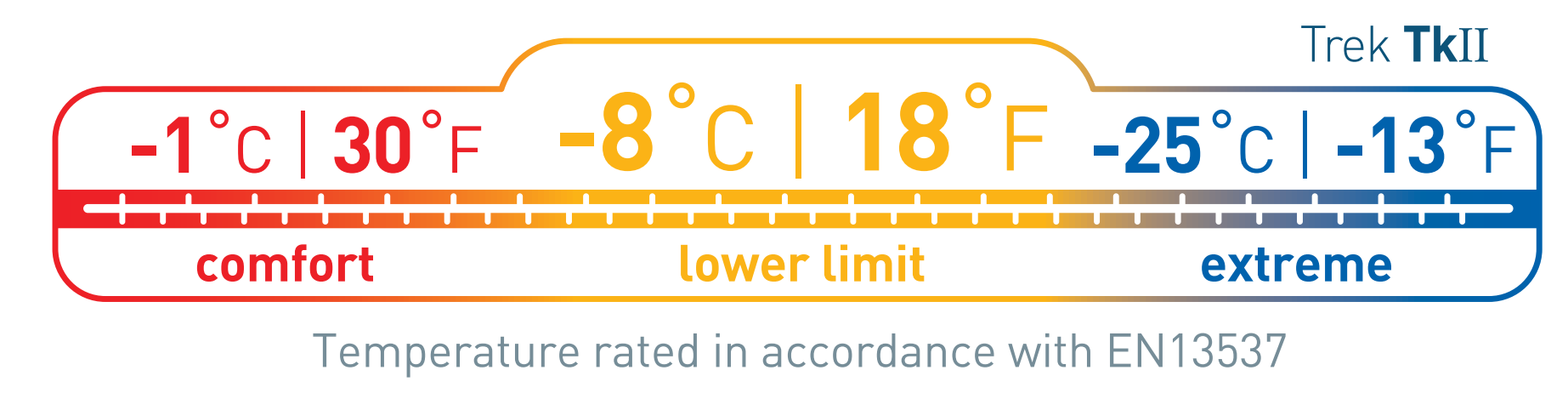
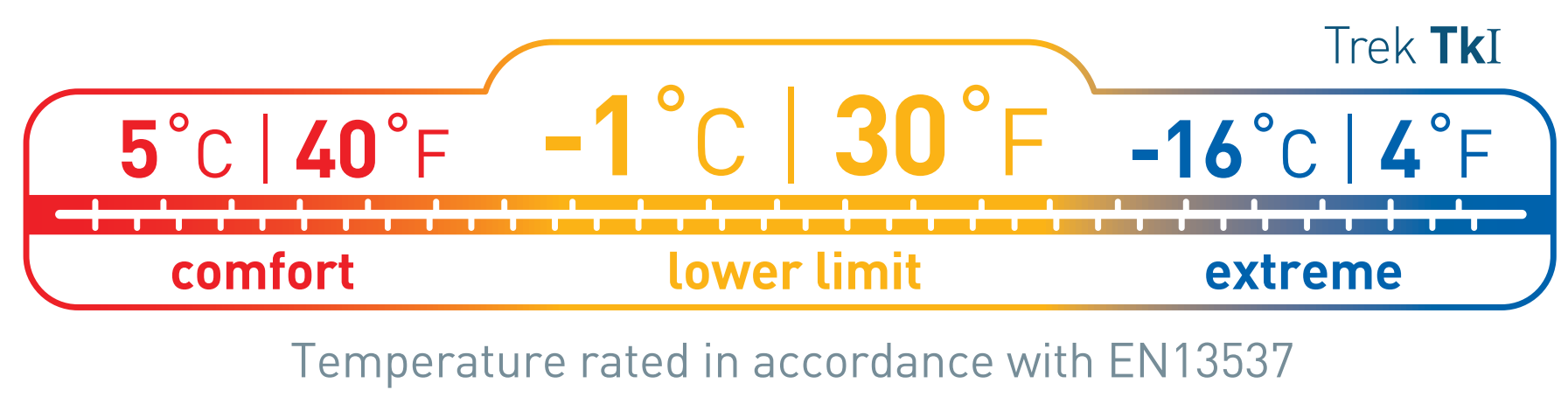

PRODUCT NAME	CODE	SIZE	MAX USER HEIGHT	WEIGHT	FILL WEIGHT	COMPRESSED SIZE	STORAGE	BAFFLE CONSTRUCTION	RRP
Trek TkI	ATK1-R	Regular	< 183 cm	760g	350g	ø18.5 x 17cm   4.6L	S / 10L	Vertical chest baffles, horizontal baffles lower half and base, box wall baffle construction on top and sewn through on base	
	ATK1-RW	Regular Wide		920g	450g	ø18.5 x 23cm   6.2L			
	ATK1-L	Long	< 198 cm	850g	400g	ø18.5 x 21cm   5.5L			
Trek TkII	ATK2-R	Regular	< 183 cm	980g	500g	ø18.5 x 23cm   6.1L	M / 14L	Vertical chest baffles, horizontal baffles lower half and base, box wall baffle construction throughout	
	ATK2-RW	Regular Wide		1160g	600g	ø21 x 21cm   7.4L			
	ATK2-L	Long	< 198 cm	1080g	560g	ø21 x 21cm   7.3L			
Trek TkIII	ATK3-R	Regular	< 183 cm	1190g	700g	ø21 x 24cm   8.4L			
	ATK3-L	Long	< 198 cm	1310g	780g	ø21 x 29cm   10L			

DESIGNED FOR	Unisex design
ZIPS	Full length YKK #5 side zip, two sliders. YKK #5 foot opening zip
PAIRING	This bag IS designed to pair with another
SHAPE	Tapered rectangular
FEATURES	Full length zipper provides maximum versatility, including the option to use as a quilt in warmer conditions
NECK DRAFT TUBE	TkI-II: <input type="checkbox"/> TkIII: <input checked="" type="checkbox"/>
SECURITY POCKET	<input checked="" type="checkbox"/>



# Journey Jo

Regular	Long
148cm   58"	152cm   60"
148cm   58"	152cm   60"
118cm   46"	122cm   48"
<183cm   6' MAX USER HEIGHT	<198cm   6'6"

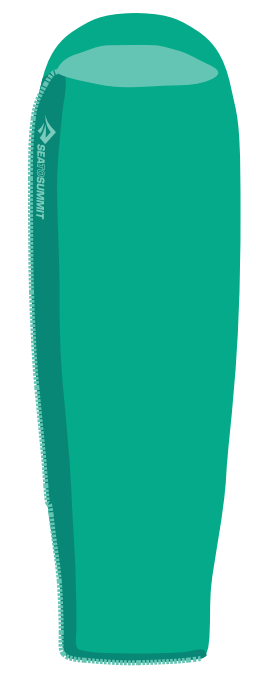

Temperature rated in accordance with EN13537

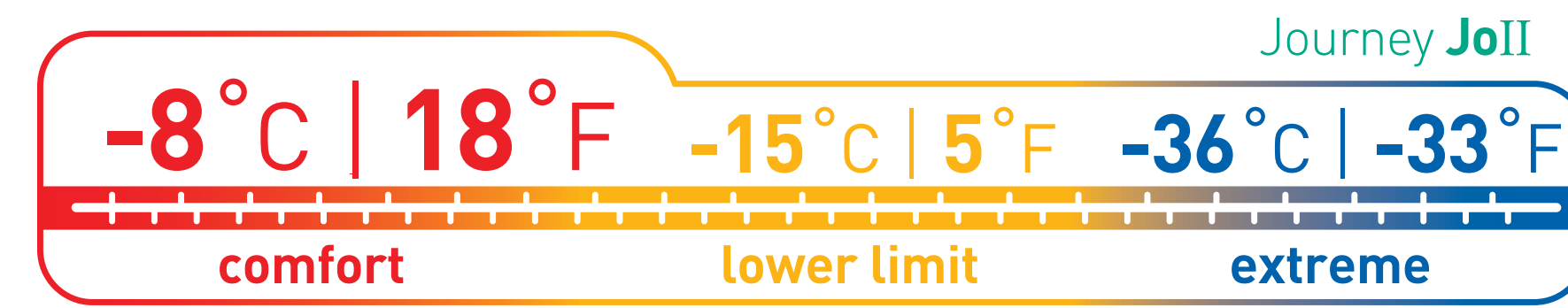

Temperature rated in accordance with EN13537



PRODUCT NAME	CODE	SIZE	MAX USER HEIGHT	WEIGHT	FILL WEIGHT	COMPRESSED SIZE	STORAGE	BAFFLE CONSTRUCTION	RRP
Journey JoI	AJ01-WR	Regular	< 170 cm	960g	500g	ø18.5 x 23cm   6.2L	S / 10L	Vertical chest baffles, horizontal baffles lower half and base, box wall baffle construction throughout	
	AJ01-WL	Long	< 183cm	1050g	560g	ø18.5 x 28cm   7.4L			
Journey JoII	AJ02-WR	Regular	< 170 cm	1180g	700g	ø21 x 24cm   8.4L	M / 14L		
	AJ02-WL	Long	< 183cm	1290g	780g	ø21 x 29cm   9.9L			

- DESIGNED FOR: Women's specific design
- FEATURES: Extra down overall, THERMOLITE® panels in foot area
- ZIPS: Full length YKK #5 side zip, two sliders. YKK #5 foot opening zip
- ZIPS: Unzips to allow use as a quilt in warmer conditions
- PAIRING: This bag IS designed to pair with another
- SHAPE: Tapered rectangular
- NECK DRAFT TUBE: JoI:  JoII:
- SECURITY POCKET:





# Treeline TL



Simple and durable, yet refined, this bag is your perfect companion for uncomplicated summer adventures.

While we've given this design a little extra room around the shoulders and hips for freedom of movement, the relaxed mummy shape still provides efficient warmth and heat retention when you need it.

 **ZIP COUPLING**  
BAGS ZIP TOGETHER

 **600+** Loft

 **SUSTAINABLE DESIGN**  
CO Non-PFC Water Repellent Finish  
100% RDS Down

 VIDEO





# Treeline TL

Regular	Long
155cm   61"	165cm   65"
136cm   54"	143cm   56"
103cm   41"	107cm   42"
<183cm   6' MAX USER HEIGHT	<198cm   6'6"

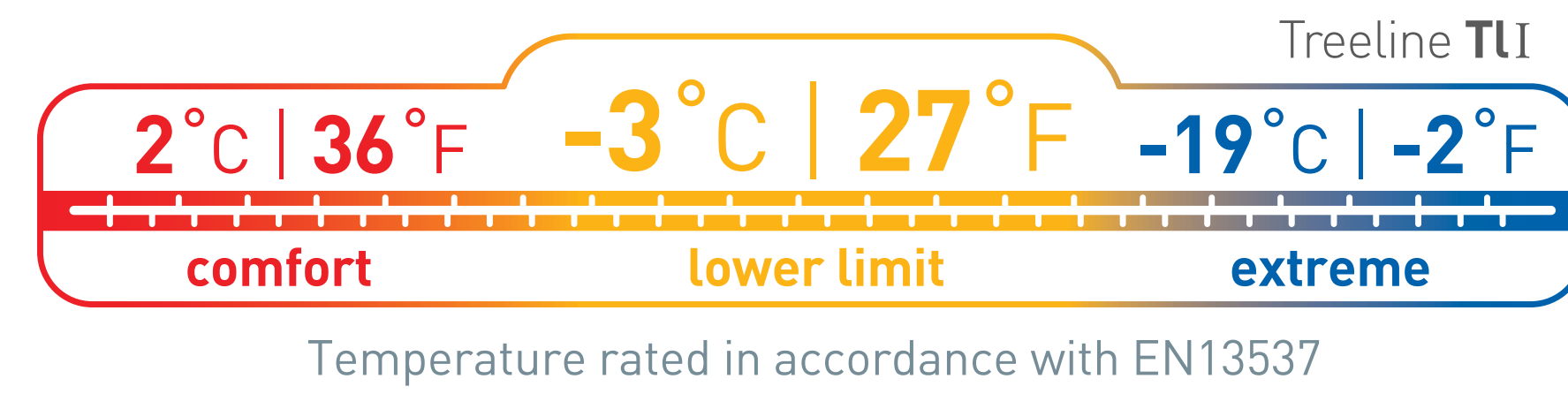

PRODUCT NAME	CODE	SIZE	MAX USER HEIGHT	WEIGHT	FILL WEIGHT	COMPRESSED SIZE	STORAGE	BAFFLE CONSTRUCTION	RRP
Treeline TL	ATL1-R	Regular	< 183 cm	970g	400g	5.4L	M / 14L	Horizontal baffles, box wall baffle construction throughout	
	ATL1-L	Long	< 198 cm	1120g	450g	6.1L			

DESIGNED FOR	Unisex design
ZIPS	Full length YKK #5 side zip, two sliders
PAIRING	This bag is designed to pair with another
SHAPE	Relaxed mummy
NECK DRAFT TUBE	
SECURITY POCKET	

# SYNTHETIC SLEEPING BAGS

Intended for use in wetter conditions, Sea to Summit's synthetic-insulated sleeping bags share many of the same technical features and ergonomic shapes as the down sleeping bag range.

Core to their performance is WaveLoft construction. Sheets of synthetic insulation are sewn in to form a 'W' cross-section, which maximizes loft for a given weight.



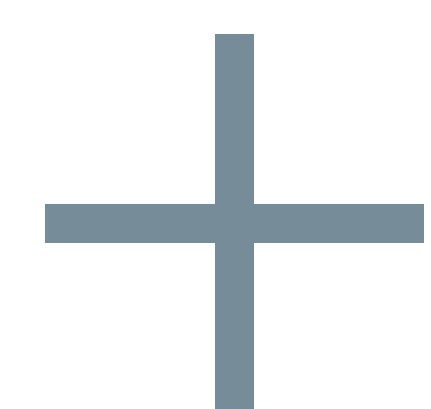

## OUR SYNTHETIC SLEEPING BAGS FEATURE:

### THERMOLITE®

#### THERMOLITE INSULATION

On our high-end bags we use a proprietary blend of THERMOLITE branded insulation, where fine denier hollow-core fibres provide higher loft and superior compressibility.

#### SOFTER LINING FABRICS

Soft-touch nylon fabric is smooth and comfortable next to skin.



#### WAVE LOFT CONSTRUCTION



WaveLoft construction uses thick layers of synthetic insulation looped together to gain extra loft and trap extra pockets of warm air for superior insulation.

#### SECURED LINING FABRIC

Lining fabric is secured to both the insulation and the shell to keep it secure, and to prevent the feeling of getting caught in a loose lining fabric.



# EXPLORE THE RANGE - SYNTHETIC BAGS

**THERMOLITE®**

SYNTHETIC INSULATION

Traverse **Tv**



Venture **Vt**



Trailhead **Th**



Quest **Qu**

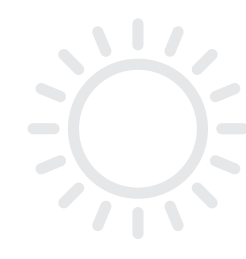

**TVII**  
-4C | 25F

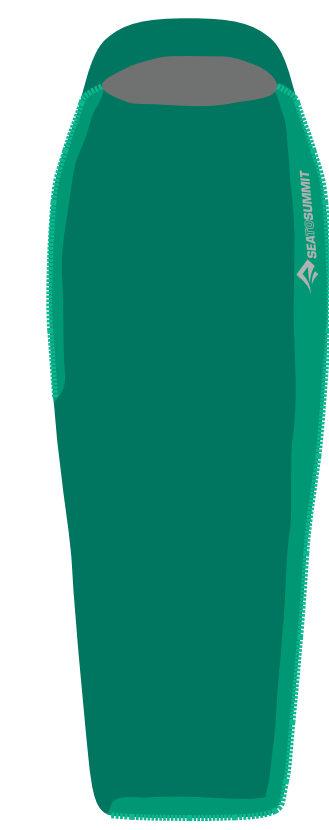

**TVIII**  
-10C | 14F

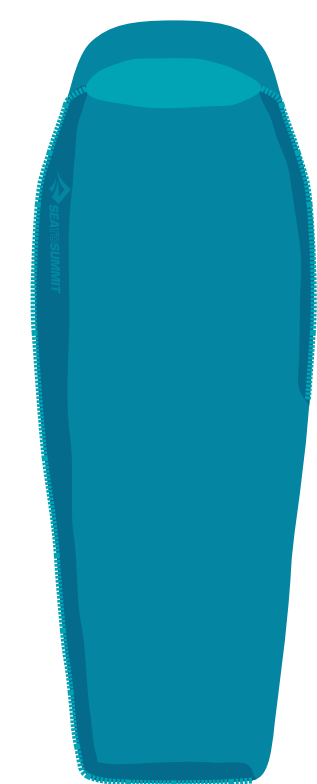

**VTII**  
0C | 32F

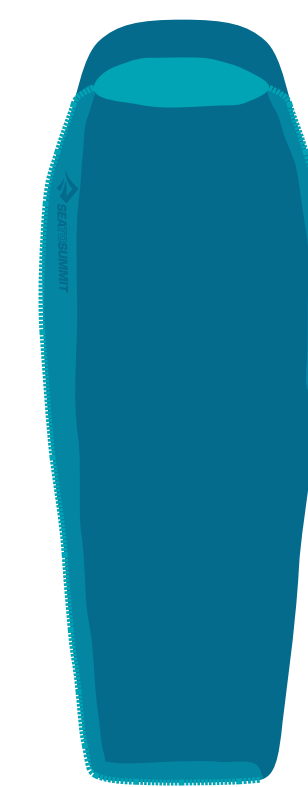

**VTIII**  
-5C | 23F



**THII**  
-1C | 30F



**THIII**  
-7C | 20F

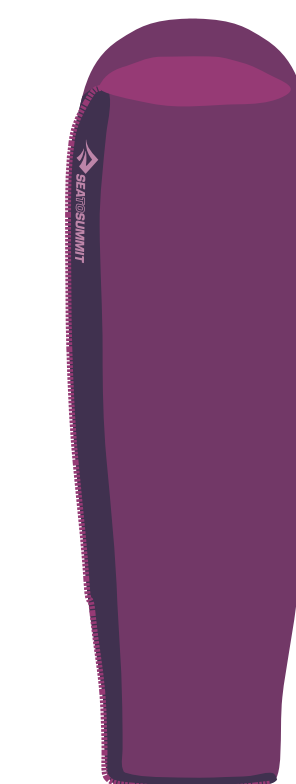

**QUI**  
3C | 37F

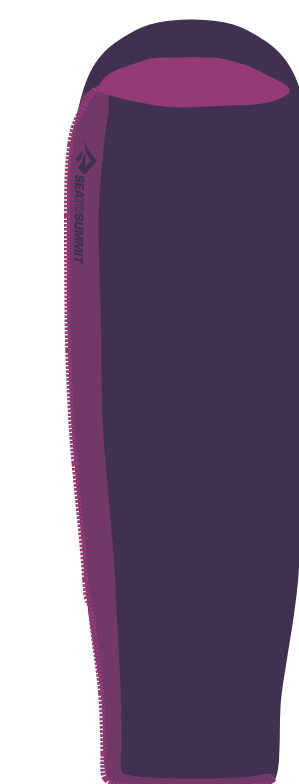

**QUII**  
-1C | 30F



# Traverse Tv



The Thermolite-insulated Traverse offers unmatched versatility and room to move in a lightweight, technical sleeping bag.

The Free-Flow zipper system, WaveLoft insulation construction and warmth retaining features give the Traverse true multiple-season flexibility.



**SUSTAINABLE DESIGN**  
CO Non-PFC Water Repellent Finish

# Venture Vt



The Venture is perfect for women looking for warmth and ventilation in a technical sleeping bag designed for use in variable weather.

WaveLoft construction using Thermolite insulation provides warmth in colder temperatures; the Free-Flow zipper system offers ventilation for warmer climates.

**ENGINEERED FOR WOMEN**



**SUSTAINABLE DESIGN**  
CO Non-PFC Water Repellent Finish



# Traverse Tv

Regular	Long
155cm   61"	165cm   65"
146cm   57"	156cm   61"
122cm   48"	129cm   51"
	
<183cm   6' MAX USER HEIGHT	<198cm   6'6"

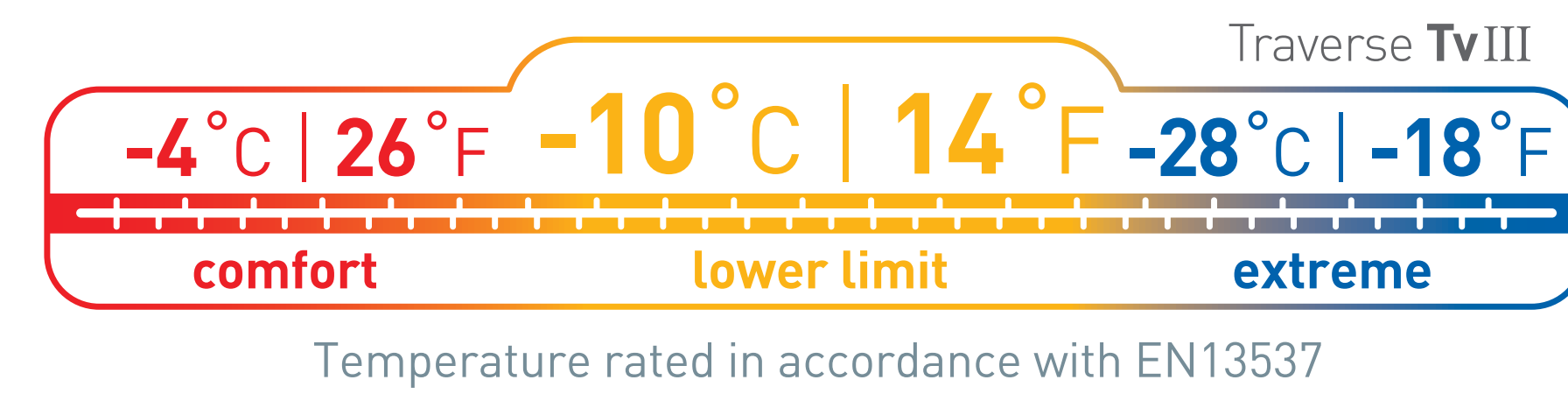
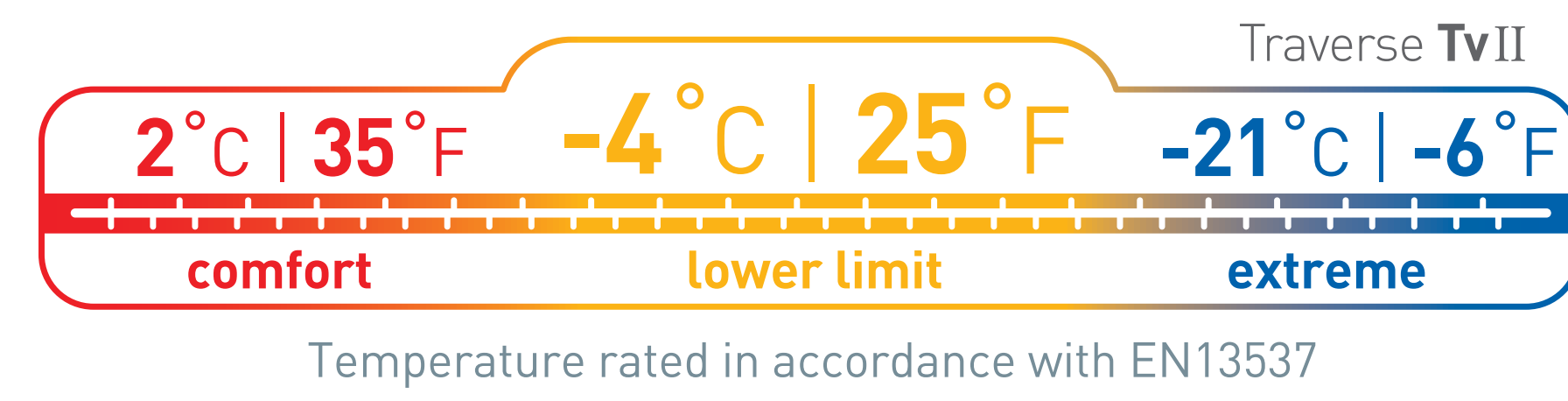

PRODUCT NAME	CODE	SIZE	MAX USER HEIGHT	WEIGHT	COMPRESSED SIZE	STORAGE	BAFFLE CONSTRUCTION	RRP
Traverse TvII	ATV1-R	Regular	< 183 cm	1130g	ø18.5 x 27cm   7.3L	S / 10L		
	ATV1-L	Long	< 198 cm	1270g	ø21 x 23cm   8.1L			
Traverse TvIII	ATV2-R	Regular	< 183 cm	1440g	ø21 x 28cm   9.8L	M / 14L	WaveLoft construction	
	ATV2-L	Long	< 198 cm	1670g	ø24 x 27cm   12.1L	L / 20L		

DESIGNED FOR	Unisex design
ZIPS	Full length YKK #5 side zip, two sliders. 1/2 length YKK #5 Free-flow zip. YKK #5 foot opening zip.
PAIRING	This bag IS designed to pair with another
SHAPE	Tapered rectangle
NECK DRAFT TUBE	TvII: <input type="checkbox"/> TvIII: <input checked="" type="checkbox"/>
SECURITY POCKET	<input type="checkbox"/>



# Venture Vt

Regular		Long	
148cm   58"		152cm   60"	
148cm   58"		152cm   60"	
118cm   46"		122cm   48"	
<183cm   6' MAX USER HEIGHT		<198cm   6'6"	

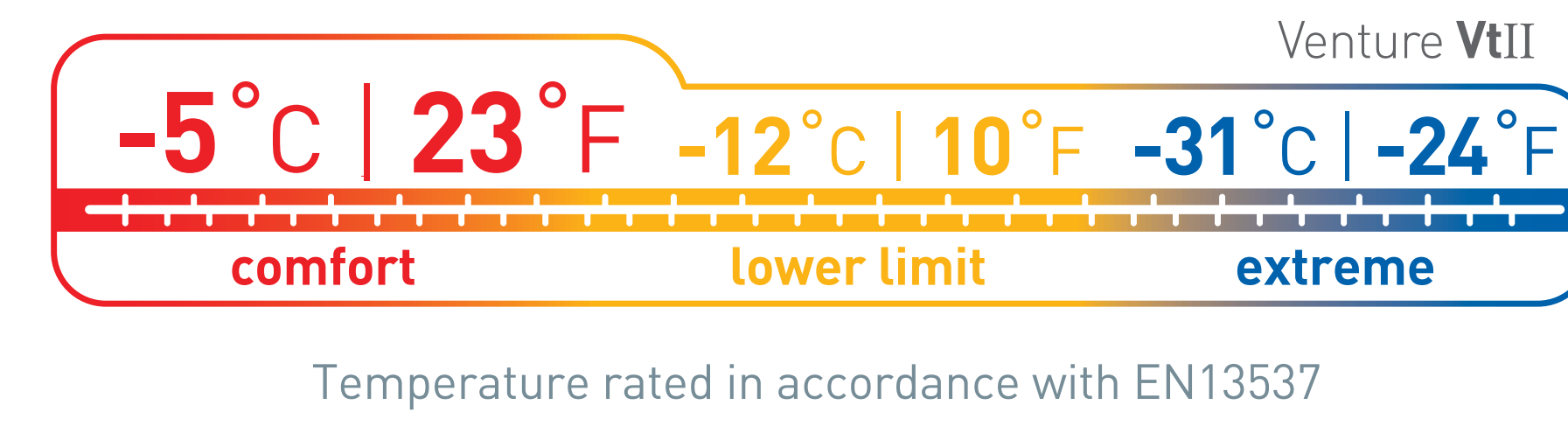
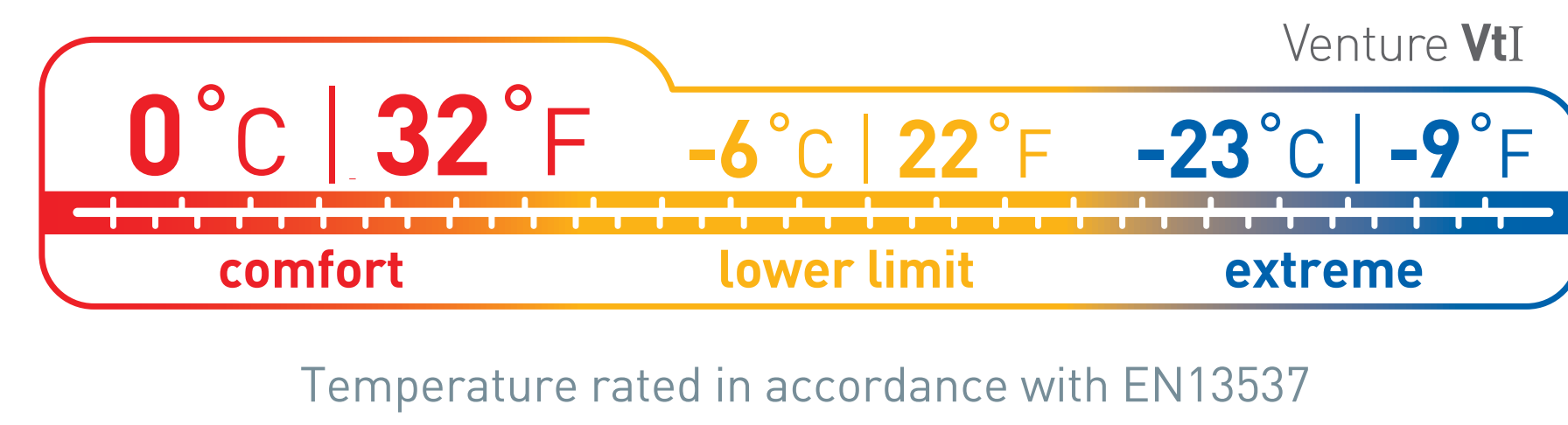

PRODUCT NAME	CODE	SIZE	MAX USER HEIGHT	WEIGHT	COMPRESSED SIZE	STORAGE	BAFFLE CONSTRUCTION	RRP
Venture VtI	AVT1-WR	Regular	< 170 cm	1090g	ø18.5 x 25cm   6.6L	S / 10L		
	AVT1-WL	Long	< 183cm	1240g	ø21 x 22cm   7.6L			
Venture VtII	AVT2-WR	Regular	< 170 cm	1380g	ø21 x 26cm   8.9L	M / 14L	WaveLoft construction	
	AVT2-WL	Long	< 183cm	1550g	ø24 x 25cm   11.5L	L / 20L		

- DESIGNED FOR: Women's specific design
- FEATURES: Thicker footbox insulation for increased warmth
- ZIPS: Full length YKK #5 side zip, two sliders. 1/2 length YKK #5 Free-flow zip. YKK #5 foot opening zip.
- PAIRING: This bag IS designed to pair with another
- SHAPE: Tapered rectangular
- NECK DRAFT TUBE:
- SECURITY POCKET:





# Trailhead Th



A refined take on the classic synthetic trail bag, our Trailhead is packed full of technical features in a no fuss, uncomplicated design.

The perfect feature-packed, value oriented synthetic bag for weekend warriors and new campers.



# Quest Qu



Quest is an ideal entry-level bag for women new to backpacking and camping

Cinch the drawcords tight in colder weather, or open the bag flat as a quilt in summer conditions.

ENGINEERED FOR WOMEN





# Trailhead Th

Regular	Long
148cm   58"	152cm   60"
148cm   58"	152cm   60"
118cm   46"	122cm   48"
	
<p>&lt;183cm   6' MAX USER HEIGHT &lt;198cm   6'6"</p>	

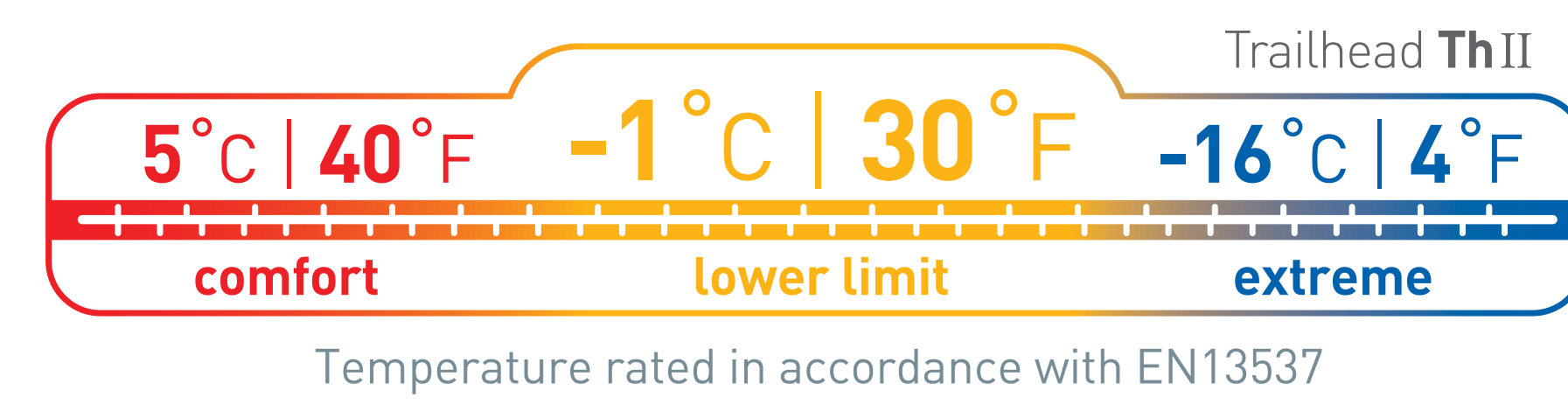

PRODUCT NAME	CODE	SIZE	MAX USER HEIGHT	WEIGHT	COMPRESSED SIZE	STORAGE	BAFFLE CONSTRUCTION	RRP
Trailhead ThII	ATH2-R	Regular	< 183 cm	1040g	ø18 x 34cm   7.1L	M/ 9L	WaveLoft construction	
	ATH2-RW	Regular Wide		1220g	ø21 x 40cm   8.0L			
	ATH2-L	Long	< 198 cm	1200g	ø21 x 40cm   9.3L	L / 15L		
Trailhead ThIII	ATH3-R	Regular	< 183 cm	1370g	ø21 x 40cm   10.2L		WaveLoft construction	
	ATH3-RW	Regular Wide		1550g	ø24 x 45cm   10.9L			
	ATH3-L	Long	< 198 cm	1530g	ø24 x 45cm   12.1L	XL / 20L		

- DESIGNED FOR: Unisex design
- ZIPS: YKK #5 full length side and foot zip, two sliders.
- ZIPS: Full length zipper allows bag to be used as a quilt
- PAIRING: This bag is NOT designed to pair with another
- SHAPE: Tapered rectangular
- NECK DRAFT TUBE
- SECURITY POCKET



# Quest Qu

Regular	Long
148cm   58"	152cm   60"
148cm   58"	152cm   60"
118cm   46"	122cm   48"
<183cm   6' MAX USER HEIGHT	<198cm   6'6"

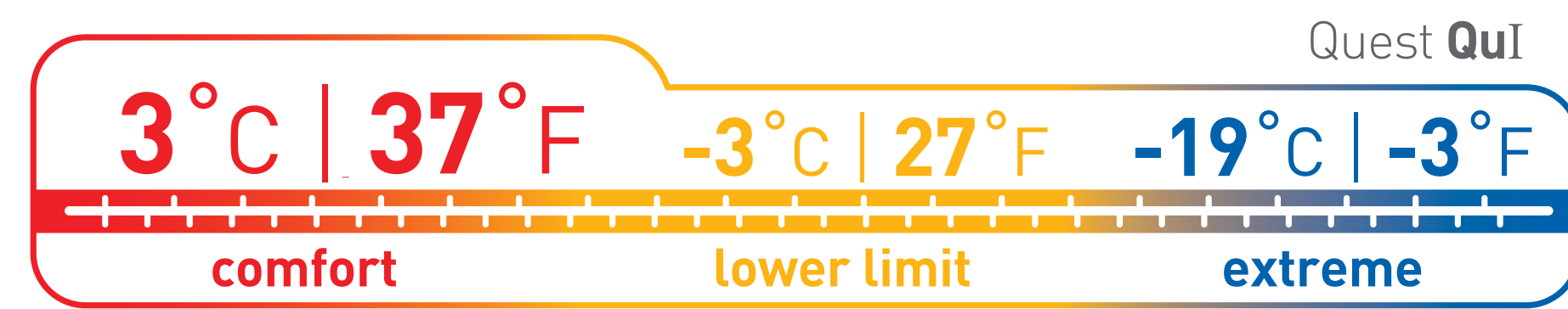
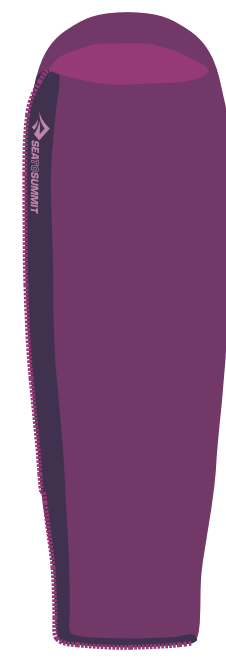

Temperature rated in accordance with EN13537

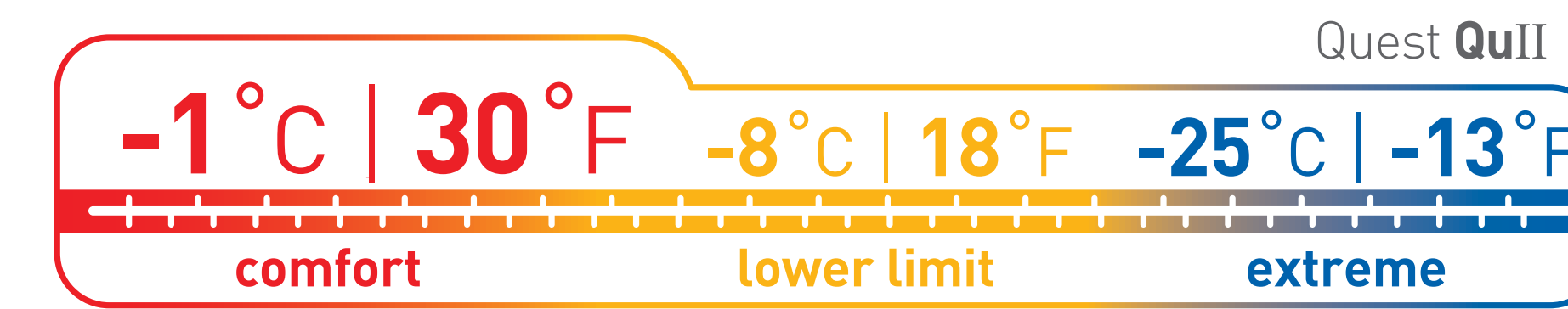

Temperature rated in accordance with EN13537



PRODUCT NAME	CODE	SIZE	MAX USER HEIGHT	WEIGHT	COMPRESSED SIZE	STORAGE	BAFFLE CONSTRUCTION	RRP
Quest QuI	AQU1-WR	Regular	< 170 cm	1030g	ø18.5 x 26cm   6.9L	S / 10L		
	AQU1-WL	Long	< 183cm	1160g	ø21 x 24cm   8.3L			
Quest QuII	AQU2-WR	Regular	< 170 cm	1340g	ø21 x 28cm   9.8L	M / 14L	WaveLoft construction	
	AQU2-WL	Long	< 183cm	1490g	ø24 x 25cm   11.2L	L / 20L		

- DESIGNED FOR: Women's specific design
- FEATURES: Thicker footbox insulation for warmer feet
- ZIPS: YKK #5 full length side and foot zip, two sliders.
- PAIRING: This bag is NOT designed to pair with another
- FEATURES: Full length zipper allows bag to be used as a quilt
- SHAPE: Tapered rectangular
- NECK DRAFT TUBE:
- SECURITY POCKET:



# QUILTS + COMFORTERS

Sea to Summit has a broad range of technical quilts and comforters that offer tremendous versatility in a range of conditions and environments.

Whether you're looking to add some coziness to your rooftop tent, extend the range of your sleeping bag or simply lighten your load on the next summer backpacking.



# EXPLORE THE RANGE - QUILTS + COMFORTERS

DOWN COMFORTERS

DOWN QUILTS

SYNTHETIC QUILTS

Tanami **Tm**



Tanami **TmI**  
10c | 50F

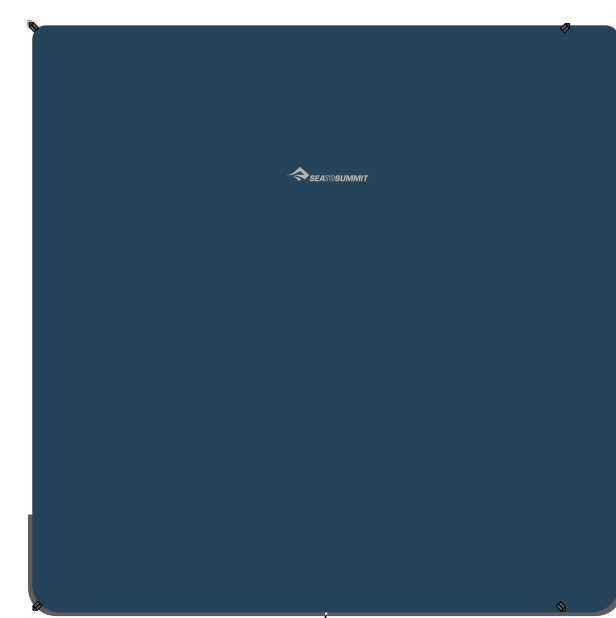

Tanami **TmII**  
2c | 35F

Ember **Eb**

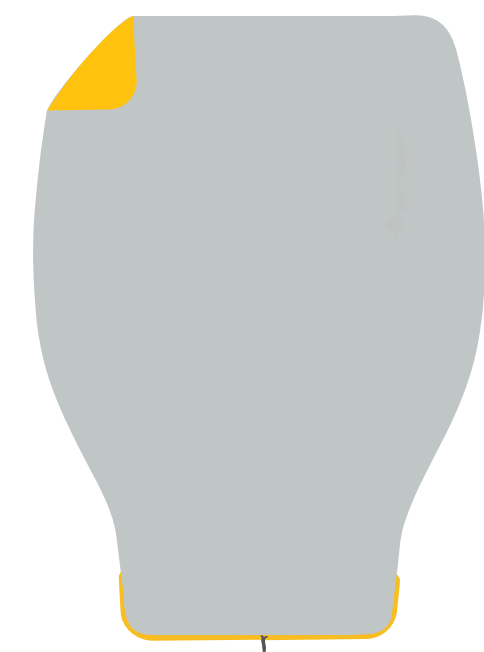

Ember **EbI**  
10c | 50F

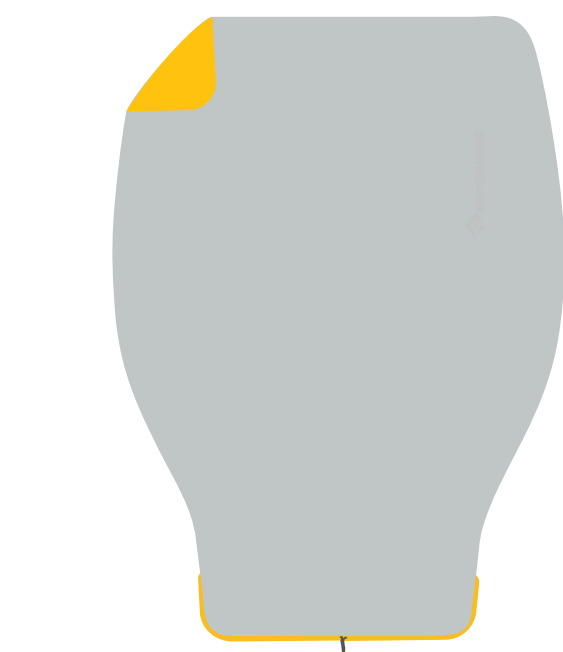
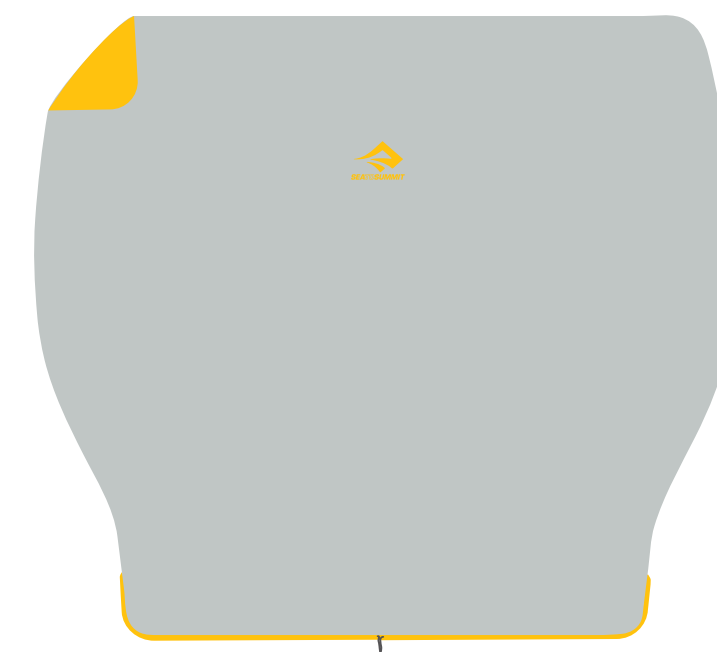

Ember **EbII**  
2c | 35F

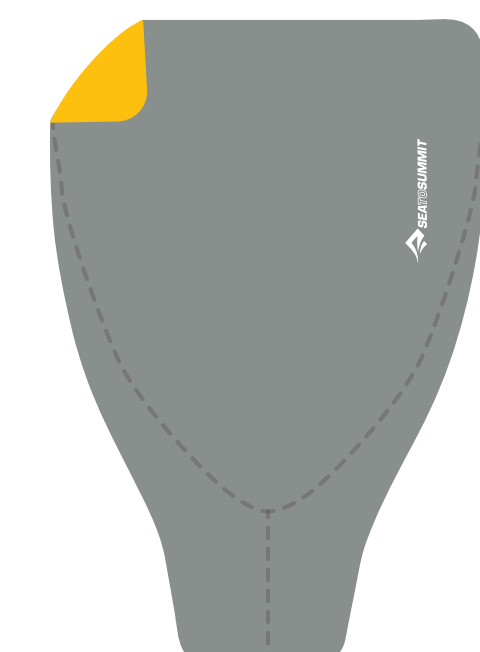

Ember **EbIII**  
-4c | 25F

Cinder **Cd**



Cinder **CdI**  
10c | 50F



Cinder **CdII**  
2c | 35F

Glow **GW**



Glow **GwI**  
10c | 50F



Glow **GwII**  
2c | 35F

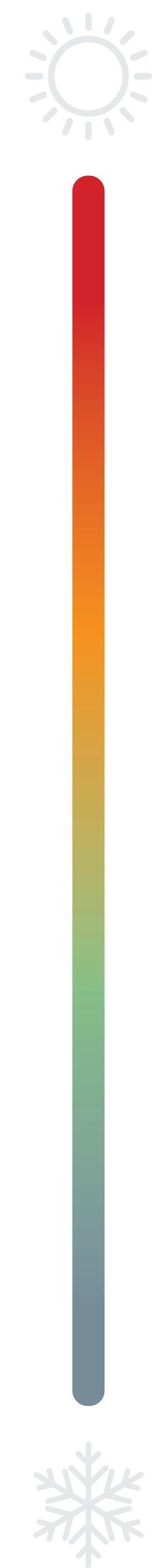



# Tanami Tm



A luxurious technical comforter perfect for life on the road.

The Tanami down comforter brings all the comfort of home to any outdoor adventure. Featuring high-loft 750+ ULTRA-DRY Down, in a traditional queen size with sewn-through quilted baffles in the Tml, and horizontal box baffles construction in the Tml.

The Tanami's soft, technical, and durable fabrics provide lightweight packability and luxurious warmth.

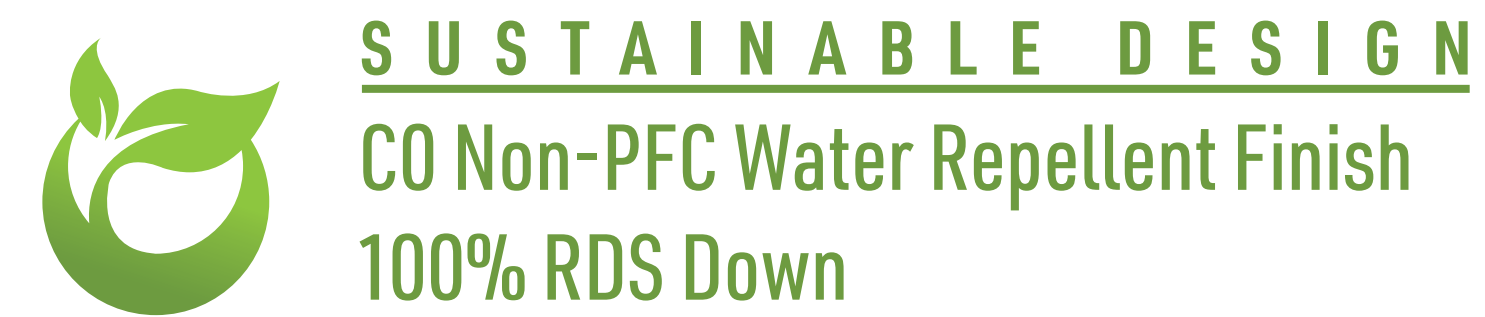



# Tanami Tm

**Queen**

210cm | 83"  
 210cm | 83"  
 210cm | 83"  
 <183cm | 6'



MAX USER HEIGHT

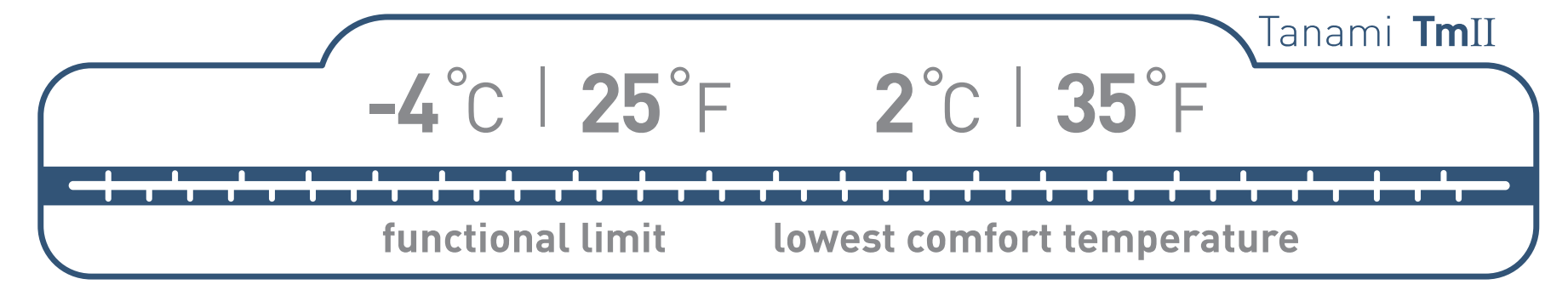
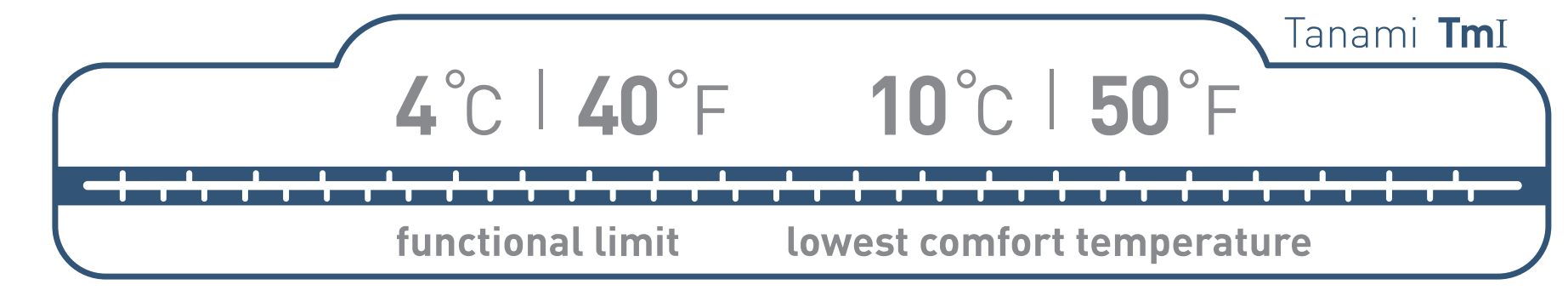

PRODUCT NAME	CODE	SIZE	MAX USER HEIGHT	WEIGHT	FILL WEIGHT	STORAGE CELL DIMENSIONS	BAFFLE CONSTRUCTION	RRP
Tanami TmI	ATM1-Q	Queen	< 183cm	815g	350g	38 x 22 x 16cm	Box quilted sewn through baffles	
Tanami TmII	ATM2-Q	Queen	< 183cm	1200g	700g	48 x 33 x 20cm	Narrow horizontal box wall baffles	

- DESIGNED FOR: Unisex design
- PAIRING: This quilt is NOT designed to pair with another
- SHAPE: Open rectangular quilt/comforter

NECK DRAFT TUBE

SECURITY POCKET



# Ember



Featherweight shell and liner fabrics, high-lofting down and functional design make the Ember quilt series incredibly light and versatile.

Ember quilts are the choice of thru-hikers, bikepackers and ultralight hikers looking for maximum warmth and minimum packed size.

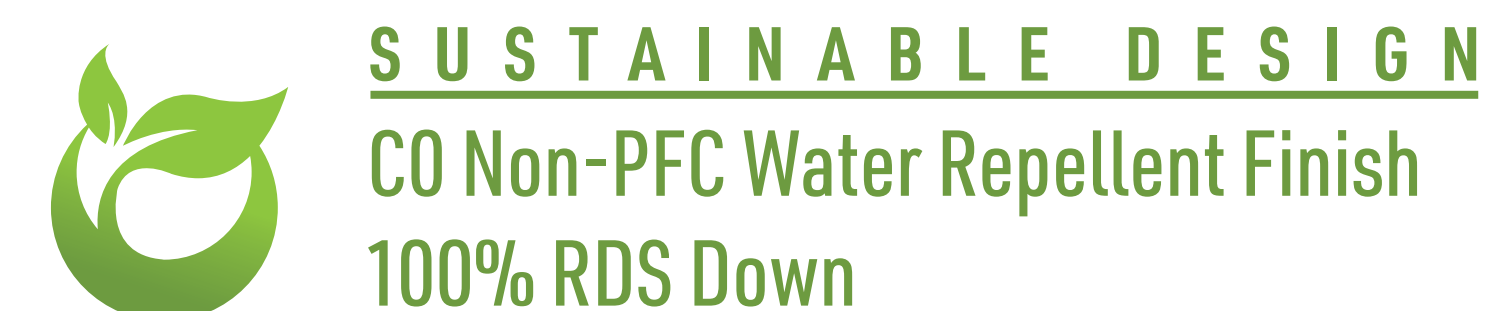





## Ember Eb

**EBI**

Regular	<b>DRAWCORD FOOTBOX</b>	Long	<b>DRAWCORD FOOTBOX</b>	Double
120cm   47"		140cm   55"		190 cm   75 in
150cm   59"		170cm   67"		210 cm   83 in
87cm   34"		97cm   38"		155 cm   61 in
<183cm   6' MAX USER HEIGHT		<198cm   6'6"	MAX USER HEIGHT	<183cm   6'

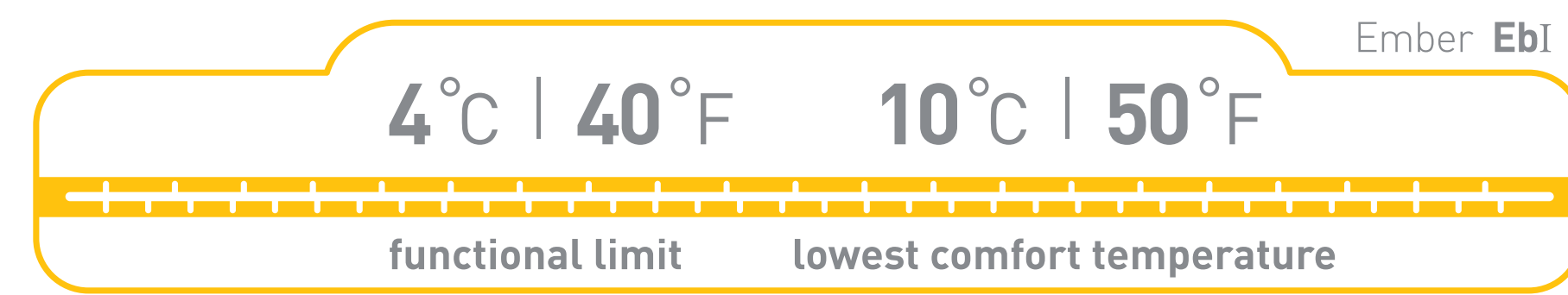
**EBII**

Regular	<b>DRAWCORD FOOTBOX</b>	Long
120cm   47"		140cm   55"
150cm   59"		170cm   67"
87cm   34"		97cm   38"
<183cm   6' MAX USER HEIGHT		<198cm   6'6"

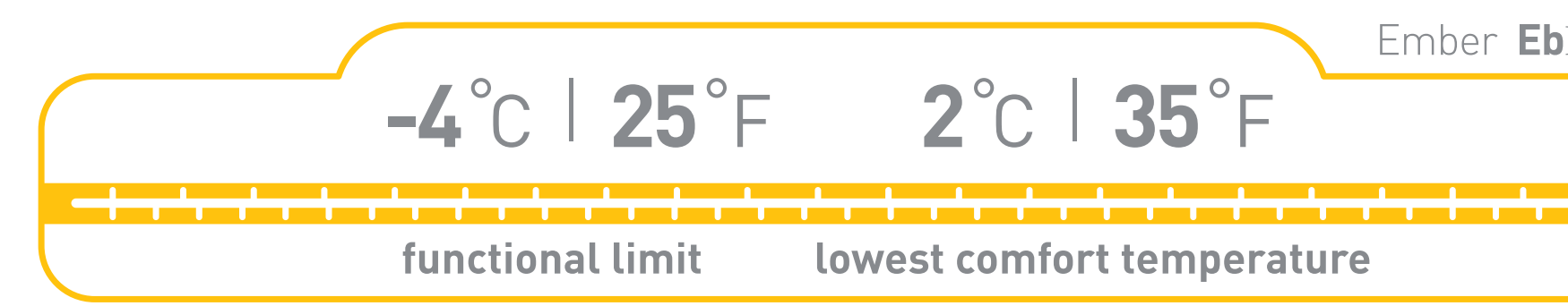
**EBIII**

Regular	<b>3D FOOTBOX</b>	Long
120cm   47"		140cm   55"
150cm   59"		170cm   67"
100cm   39"		110cm   43"
<183cm   6' MAX USER HEIGHT		<198cm   6'6"

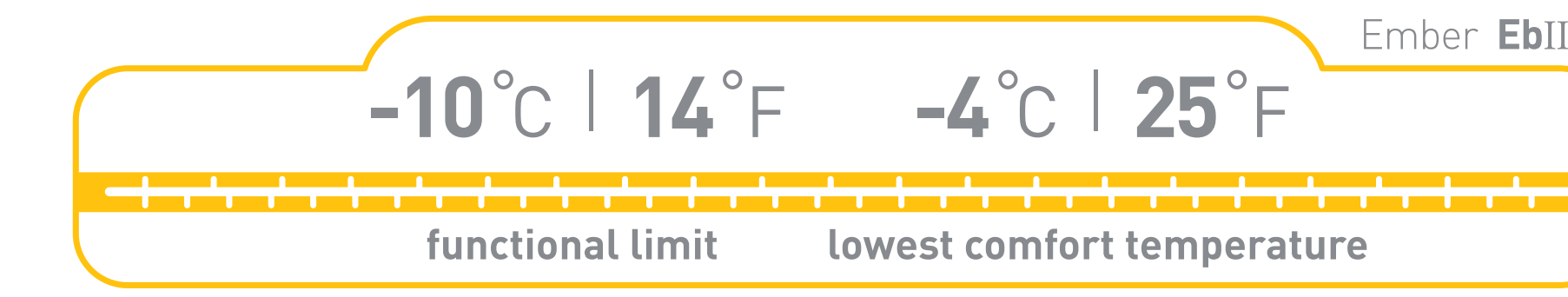

PRODUCT NAME	CODE	SIZE	MAX USER HEIGHT	WEIGHT	FILL WEIGHT	COMPRESSED SIZE	STORAGE	BAFFLE CONSTRUCTION	RRP
Ember Ebi	AEB1-R	AEB1-R	< 183 cm	420g	200g	ø13 x 14cm   1.8L	2XS / 3.3L	Box quilted sewn through baffles	
	AEB1-L	AEB1-L	< 198 cm	480g	230g	ø13 x 20cm   2.7L			
	AEB1-D	Double	< 183 cm	650g	350g	ø18.5 x 18cm   4.7L	S / 10L		
Ember EbII	AEB2-R	Regular	< 183 cm	600g	350g	ø15.5 x 20cm   3.7L	XS / 6L	Vertical chest baffles, horizontal baffles lower half, box wall baffle construction throughout	
	AEB2-L	Long	< 198 cm	680g	400g	ø15.5 x 26cm   4.9L			
Ember EbIII	AEB3-R	Regular	< 183 cm	725g	500g	ø18.5 x 20cm   5.4L	S / 10L	Vertical chest baffles, horizontal baffles lower half, box wall baffle construction throughout, sewn in footbox	
	AEB3-L	Long	< 198 cm	830g	575g	ø18.5 x 25cm   6.8L			

DESIGNED FOR	Unisex design
CLOSURE	Press stud closure
PAIRING	This quilt IS designed to pair with another
SHAPE	Ebi-II: Open tapered quilt/ mummy bag EbIII: Box foot tapered quilt/ mummy bag
NECK DRAFT TUBE	Ebi: <input type="checkbox"/> EbII-III: <input checked="" type="checkbox"/>
SECURITY POCKET	<input type="checkbox"/>
EXTRAS SUPPLIED	Removable straps to secure quilt to mattress with low profile quick release adjustable buckle



# Cinder Cd



Think outside the bag  
—a lightweight summer  
down quilt or extra warmth  
on top of your bag.



**SUSTAINABLE DESIGN**  
CO Non-PFC Water Repellent Finish  
100% RDS Down

# Glow GW



Light, packable standalone  
synthetic summer quilt or  
pair it with a sleeping bag  
to boost performance.



**SUSTAINABLE DESIGN**  
CO Non-PFC Water Repellent Finish



# Cinder Cd

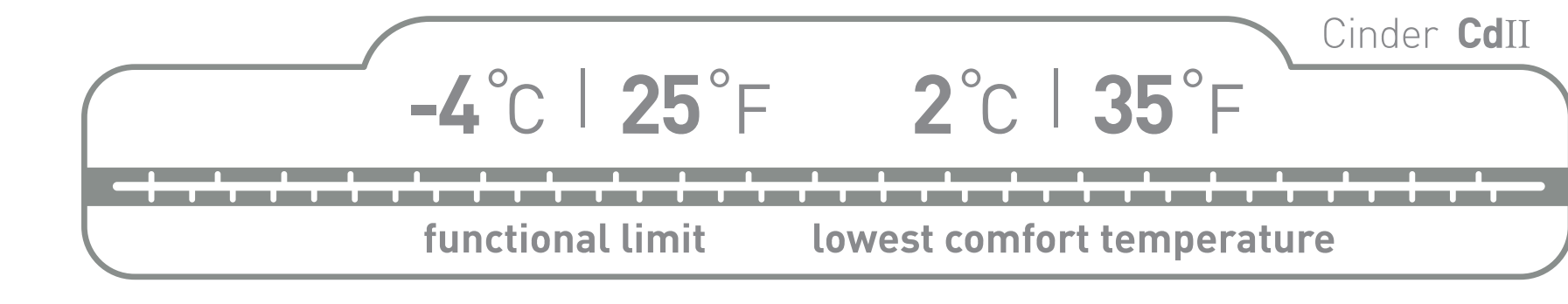
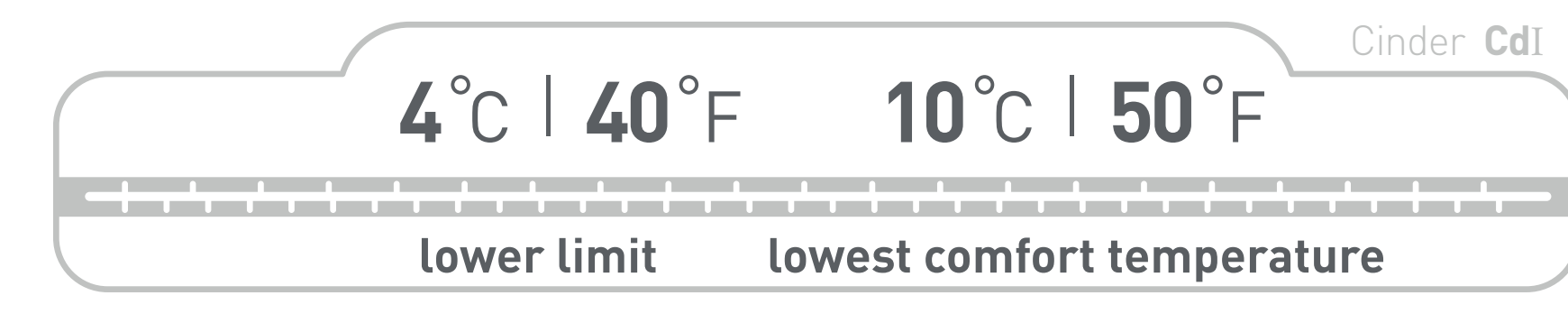
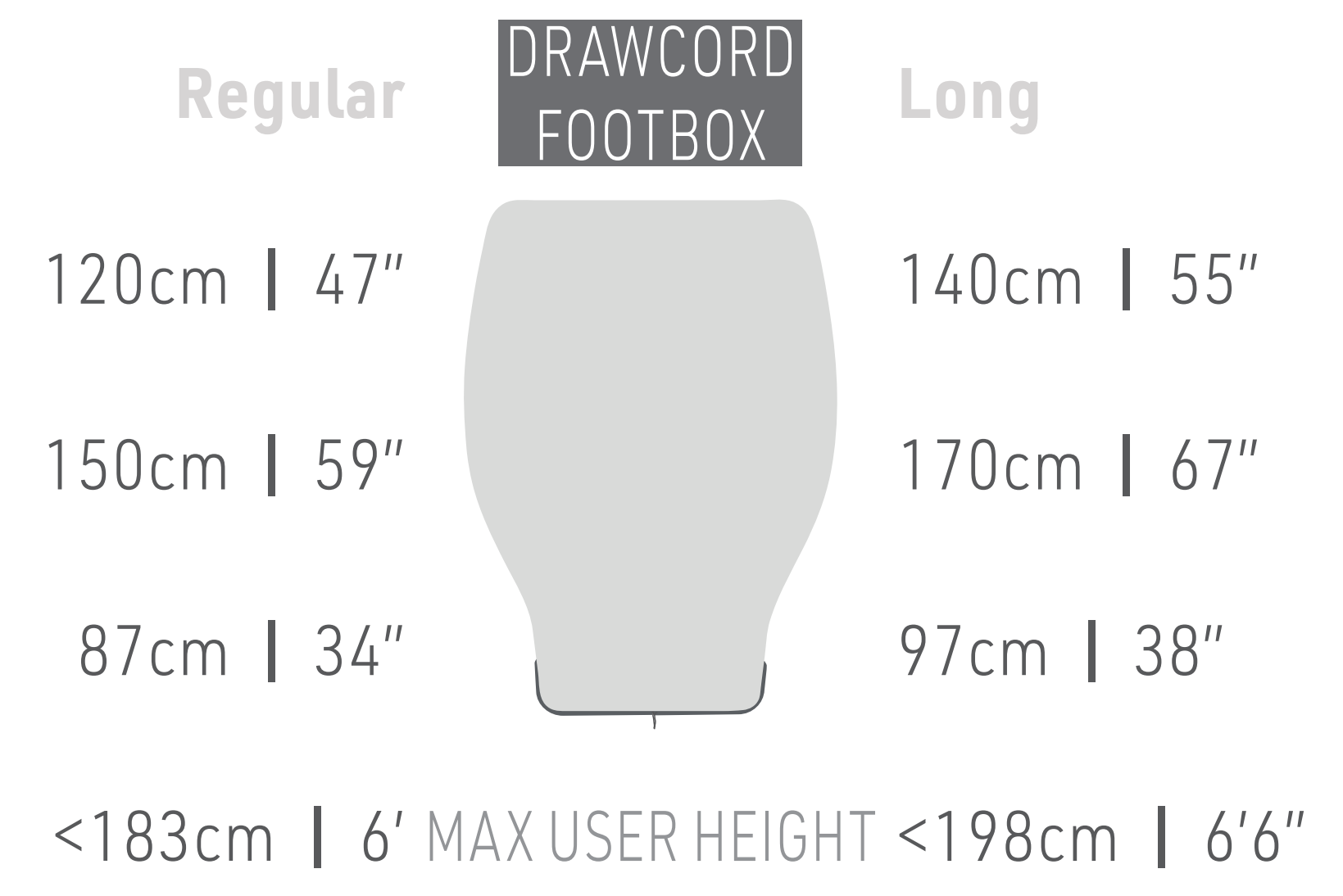

PRODUCT NAME	CODE	SIZE	MAX USER HEIGHT	WEIGHT	FILL WEIGHT	COMPRESSED SIZE	STORAGE	BAFFLE CONSTRUCTION	RRP
Cinder CdI	ACD1-R	Regular	< 198cm	480g	240g	ø15.5 x 12cm   2.3L	XS / 6L	Box quilted sewn through baffles	
	ACD1-L	Large	< 198cm	620g	300g	ø18.5 x 13cm   3.5L	S / 10L		
Cinder CdII	ACD2-R	Regular	< 198cm	660g	420g	ø18.5 x 17cm   4.6L	S / 10L	Vertical chest baffles, horizontal baffles lower half, box wall baffle construction throughout	
	ACD2-L	Large	< 198cm	790g	500g	ø21 x 17cm   5.7L	M / 14L		

- DESIGNED FOR: Unisex design
- CLOSURE: Press stud closure
- PAIRING: This quilt IS designed to pair with another
- SHAPE: Open tapered quilt/mummy bag
- NECK DRAFT TUBE: CdI:  CdII:
- SECURITY POCKET:
- EXTRAS SUPPLIED: Removable straps to secure quilt to mattress with low profile quick release adjustable buckle



# Glow Gw

**Regular** **DRAWCORD FOOTBOX** **Long**

120cm   47"		140cm   55"
150cm   59"		170cm   67"
87cm   34"		97cm   38"
<183cm   6' MAX USER HEIGHT <198cm   6'6"		

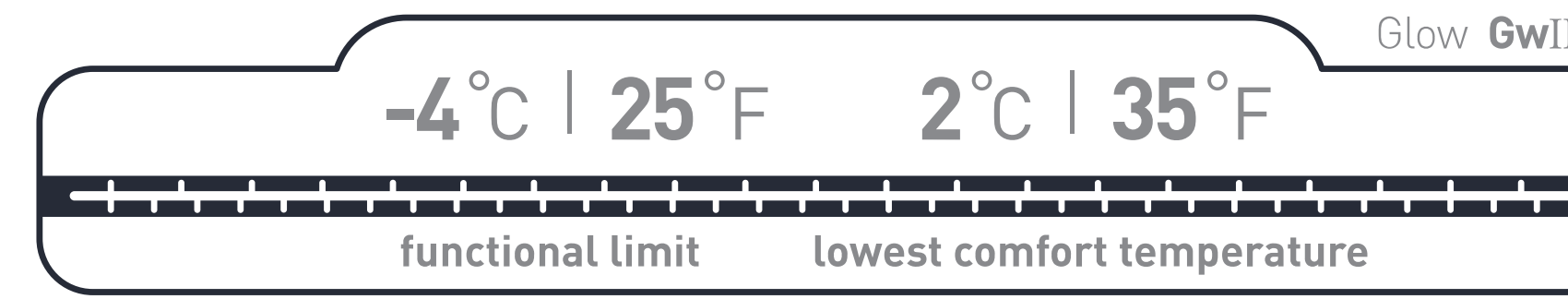
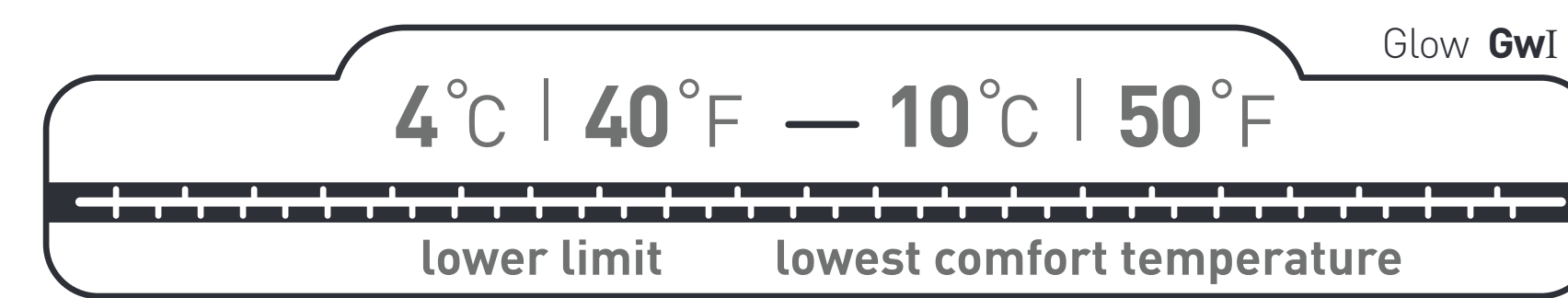

PRODUCT NAME	CODE	SIZE	MAX USER HEIGHT	WEIGHT	COMPRESSED SIZE	STORAGE	RRP
Glow GwI	AGW1-R	Regular	< 198cm	650g	ø15.5 x 18cm   3.4L	XS / 6L	
	AGW1-L	Long	< 198cm	820g	ø18.5 x 17cm   4.6L	S / 10L	
Glow GwII	AGW2-R	Regular	< 198cm	900g	ø21 x 20cm   6.9L	M / 14L	
	AGW2-L	Long	< 198cm	1030g	ø21 x 22cm   7.6L		

- DESIGNED FOR: Unisex design
- CLOSURE: Press stud closure
- PAIRING: This quilt IS designed to pair with another
- SHAPE: Open tapered quilt/mummy bag
- NECK DRAFT TUBE:
- SECURITY POCKET:
- EXTRAS SUPPLIED: Removable straps to secure quilt to mattress with low profile quick release adjustable buckle

# +

## OUR SLEEPING BAGS FEATURE:

### QUALITY MATERIALS



#### CO DWR

Non-PFC fabrics with CO treatment provide environmentally friendly resistance to condensation or other moisture.

#### INDEPENDENTLY TESTED

All of our sleeping bags are independently tested in Norway to the EN/ISO standard for published Sleeping Bag warmth.

#### TECHNICAL FABRICS

Are selected balancing weight, breathability, quietness, water resistance, and comfort for each model.

#### YKK ZIPPERS

YKK Zippers are strong and durable.

### DESIGN DETAILS



#### FREE FLOW ZIP SYSTEM

Our Free Flow Zip System offers greater versatility and comfort across a wider temperature range.



#### ZIP COUPLING

Most bags are designed to be zipped together to create double sized sleeping sacks.

#### INTERNAL POCKETS

Small Zippered Pockets inside your bag provide space for valuables or small electronics in freezing conditions.



#### QUILT LOCK SYSTEM

Every Sleeping Bag can combine with a quilt to increase warmth.

#### ZIPPER DRAFT TUBES

Zip Draft Tubes with anti-snap prevent cold leaching in via the zipper opening.

#### INTERNAL CORD TUNNELS

Our Cord Tunnels are buried within Draft Tubes to keep drawcords from irritating your face or neck.

#### CLEVER ADJUSTMENT

Hood and Collar Draft Tubes all have dual adjusters, one on each side, for even cinching and maximum warmth.

### STORAGE SOLUTIONS

#### AT HOME STORAGE

Zippered Storage Cell for keeping your bag lofty when packed away at home.

#### BETTER COMPRESSION

Three-strap "flip top" compression sacks for easy storage and packing (except Treeline).





## OUR DOWN SLEEPING BAGS FEATURE:

### QUALITY MATERIALS



#### RESPONSIBLE DOWN STANDARD (RDS)

The RDS is helping to shift the entire down and feather industry towards more humane animal rearing and handling practices. Overseen by the industry leading Textile Exchange, the RDS requires independent, third party assessments of all aspects of animal rearing and handling throughout the entire supply chain.

To find out more about how the RDS is improving animal welfare during down collection, please visit [responsibledown.org](https://responsibledown.org)

#### ULTRA-DRY DOWN

Ultra-Dry Down is a Non-PFC, permanent polymer treatment that absorbs 30% less moisture and dries 60% quicker than untreated down.

#### UNIQUE DOWN CERTIFICATE

Each bag includes a Batch Test Report from the International Down and Feather Laboratory to certify the loft and quality of down used.

#### MINIMUM FILL RATING

All down used in our bags exceeds the published loft that is specified for that model.

### DESIGN DETAILS

#### BESPOKE DESIGN

The baffle height in our bags is adjusted for each variant, so that the down insulation has the perfect amount of space in which to achieve maximum loft.

#### DIFFERENTIAL CUT

A differentially cut shell design allows the down to expand outward for better lofting and also reduces the chance of cold spots.

#### VERTICAL CHEST BAFFLES

Vertical Chest Baffles prevent down migration and cold spots, particularly for side sleepers.

#### SIDE BLOCK BAFFLES

Side Block Baffles prevents down shifting around, and maintains warmth where it is needed.

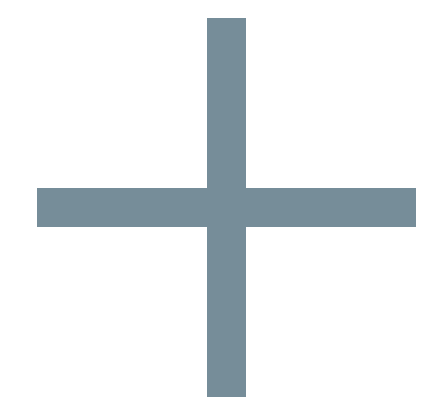

## OUR QUILTS INCLUDE:



### CO DWR

Non-PFC Fabrics with CO treatment provide environmentally friendly resistance to condensation or other moisture.



### NO WASTED WARMTH

A top drawcord helps pull your quilt in tight and press studs along the top edge allow it to be secured around your neck to help trap warmth.



### QUILT LOCK SYSTEM

Every Sleeping Bag can combine with a quilt to increase warmth.

### OPTIONAL FOOTBOX

A drawcord on the base of the quilt pulls tight to create a footbox, perfect for securing your mat and keeping your feet toasty warm.

### HAND POCKETS

Small pockets on the top corner of the quilt helps draw it closer around you, even when sleeping in a natural, side position.



### SECURE ATTACHMENT

Press Stud and Adjustable Strap System allows the quilt to be secured under your mat to retain maximum warmth.

# LINERS

A sleeping bag liner or travel liner is the foundation of any sleep system. Just like the sheets on your bed at home, it's the first point of contact between you and the rest of the system. For over 30 years Sea to Summit has offered liners designed to suit a wide range of users and environments.



## SOFT + COMFORTABLE

All our liners have great hand feel, and are soft and comfortable next to skin. Some are stretchy and knitted for people who move around during sleep and don't want to feel constricted. Others are more static, so that they don't tangle.

## CONVENIENT

Because they are acting as a 'sheet' between you and your sleeping bag, it means that you won't need to launder your bag as often (or at all), because all the grime, oil and sweat that you may exude during sleep is captured in your liner.

## EASY CARE

In between uses, you'll appreciate the fact that they are easy care, and can all be washed in a regular top loading washing machine. And they all come in a stuff sack or zippered pouch to minimise space and keep them small and compact when packed away.



# LINER OVERVIEW



PRODUCT	THERMOLITE® Reactor	Reactor Compact Plus	Reactor Extreme	Reactor Fleece	Premium Cotton Travel Liner	Silk + Cotton Travel Liner	Expander Liner	Premium Silk Travel Liner	COOLMAX® Adaptor
	PERFORMANCE LINERS				TRAVEL LINERS				
DIMENSIONS	210 x 90cm	210 x 90cm	210 x 90cm	200 x 70cm	MULTIPLE	MULTIPLE	MULTIPLE	MULTIPLE	MULTIPLE
WEIGHT	248g	263g	399g	380g	MULTIPLE	MULTIPLE	MULTIPLE	MULTIPLE	MULTIPLE
SIZE	Mummy (Box Foot)	Mummy	Mummy (Box Foot)	Mummy	Mummy (Hood)	Mummy (Hood)	Mummy (Hood)	Mummy (Hood)	Mummy (Hood)
					Mummy (Tapered)	Mummy (Tapered)		Mummy (Tapered)	
					Double	Double	Double	Double	
					Long	Long	Long	Long	
					Standard	Standard	Standard	Standard	
					Traveller	Traveller	Traveller	Traveller	Traveller
MATERIALS	80g/m <sup>2</sup> THERMOLITE®	80g/m <sup>2</sup> THERMOLITE® 110g/m <sup>2</sup> THERMOLITE® panels in core body and footbox	110g/m <sup>2</sup> THERMOLITE®	THERMOLITE® fleece	Cotton	30% silk, 70% cotton	Poly-cotton blend	AA-Grade ripstop silk, polyester/Lycra panels	Polyester
ADDED WARMTH	Up to 8°C	Up to 11°C	Up to 15°C	Up to 18°C	N/A	N/A	N/A	N/A	N/A
COLOURS									

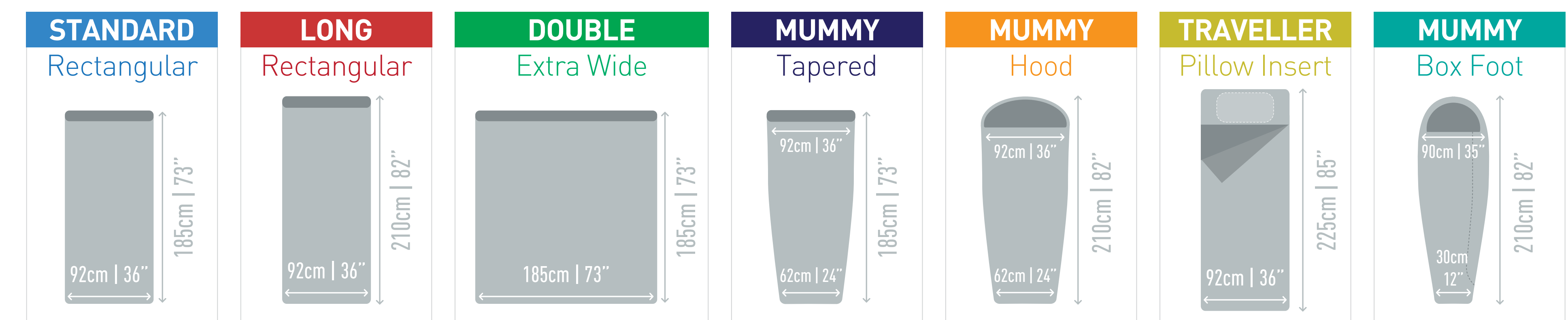



# REACTOR SERIES LINERS

Sea to Summit Reactor Series sleeping bag liners are your best choice for adding warmth to your bag.

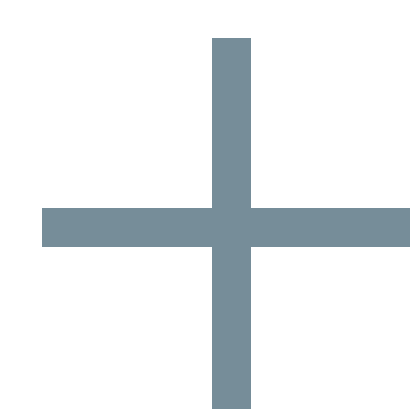

## OUR REACTOR SERIES LINERS FEATURE:

### EASE OF USE

Contrasting colour along the top edge makes it easier to find the opening.

### COMFORT

A knitted fabric stretches and moves with you as you sleep.

### WARMTH

THERMOLITE is a hollow core fibre with fantastic insulating properties, adding warmth and comfort to your bag.

### VERSATILITY

Add warmth in cold conditions, or use a stand alone bag on balmy summer nights.

### COMPACT + CONVENIENT

Packs into its own Ultra-Sil stuff sack.



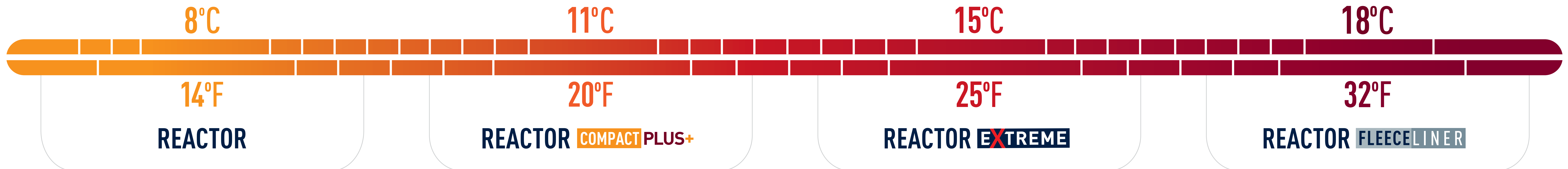

### THERMOLITE® REACTOR

Extend the comfort range of your sleeping bag with our most popular technical liner.

COLOUR



### THERMOLITE® REACTOR COMPACT PLUS

Perfect for cold-sleeping gram counters under six feet tall.

FEATURES

- Compact, shorter design is ideal for women and cold-sleepers under six feet

COLOUR



### THERMOLITE® REACTOR EXTREME

Ideal as part of a cold climate sleep system or standalone bag in warm weather.

SIZES REGULAR / LONG

COLOUR



### THERMOLITE® REACTOR FLEECE

It's so warm, you can use this fleece liner in your sleeping bag or on its own.

FEATURES

- Quarter zip makes it easy to get in and out

COLOUR





# TRAVEL LINERS



## SILK+COTTON TRAVEL LINER

A blend of soft cotton and luxurious silk creates an ideal travel liner.

### FEATURES

- Feels similar to a high-thread count cotton sheet



## PREMIUM COTTON TRAVEL LINER

High thread count 100% premium cotton liner for travel adventures.

### FEATURES

- High thread count cotton for comfort and durability



## PREMIUM STRETCH KNIT EXPANDER

This liner is lightweight, breathable, durable and ideal for use while camping or in hostels.

### FEATURES

- Stretch knit fabric that moves with you as you sleep



## PREMIUM SILK TRAVEL LINER WITH STRETCH PANELS

A touch of travelling luxury—premium silk liner with stretch panels for extra comfort.

### FEATURES

- Unique Comfort Stretch Panels allow the liner to move with you when you sleep

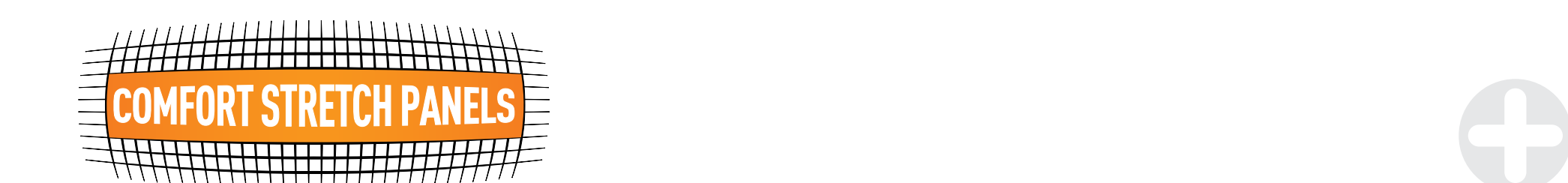



# TRAVEL LINERS



## COOLMAX® ADAPTOR

When the temperature increases our Adaptor liner helps to wicks moisture away from your skin keeping you more comfortable as you sleep.

### FEATURES

- Also works fantastically well as a regular sleeping bag liner in cooler conditions
- Contrasting colour along top edge makes it easier to find the opening

COLOUR





## REACTOR LINERS

PRODUCT NAME	CODE	SIZE	ADDED WARMTH	DIMENSIONS	WEIGHT	MATERIALS	COLOUR	RRP
THERMOLITE® Reactor	AREACTOR	Mummy (box foot)	Up to 8°C	210 x 90cm	248g	80g/m <sup>2</sup> THERMOLITE®		
Reactor Compact Plus	AREACTPL	Mummy	Up to 11°C	210 x 90cm	263g	80g/m <sup>2</sup> THERMOLITE® 110g/m <sup>2</sup> THERMOLITE® panels in core body and footbox		
Reactor Extreme	AREACTEX	Mummy (box foot)	Up to 15°C	210 x 90cm	399g	110g/m <sup>2</sup> THERMOLITE®		
Reactor Extreme Long	AREACTEXLONG			235 x 90cm	422g			
Reactor Fleece	AREACTFLEECE	Mummy	Up to 18°C	200 x 70cm	380g	THERMOLITE® fleece		

## TRAVEL LINERS

PRODUCT NAME	CODE	SIZE	DIMENSIONS	WEIGHT	MATERIALS	COLOUR	RRP
Silk+Cotton Travel Liner	ASLKCTNDBL	Double	185 x 185cm	274g	30% silk, 70% cotton		
	ASLKCTNHODD	Mummy (Hood)	210 x 92cm	140g			
	ASLKCTNLONG	Long	185 x 92cm	156g			
	ASLKCTNMUMMY	Mummy (Tapered)	185 x 92cm	130g			
	ASLKCTNSTD	Standard	185 x 92cm	142g			
	ASLKCTNYHA	Traveller	225 x 92cm	168g			
Premium Cotton Travel Liner	ADBLOS	Double	185 x 185cm	710g	Cotton		
	ALONGOS	Long	210 x 92cm	395g			
	AMUMMYOS	Mummy (Tapered)	185 x 92cm	325g			
	ASTDOS	Standard	185 x 92cm	350g			
	AYHAOS	Traveller	225 x 92cm	425g			
	AYHOOD	Mummy (Hood)	210 x 92cm	370g			



## TRAVEL LINERS

PRODUCT NAME	CODE	SIZE	DIMENSIONS	WEIGHT	MATERIALS	COLOUR	RRP
Expander Liner	AEXPDBL	Double	185 x 185cm	500g	Poly-cotton blend		
	AEXP Hood	Mummy (Hood)	210 x 92cm	300g			
	AEXPLONG	Long		350g			
	AEXPSTD	Standard	185 x 92cm	248g			
	AEXPYHA	Traveller	225 x 92cm	380g			
Premium Silk Travel Liner	ASILKCSDB	Double	185 x 185cm	210g	AA-Grade ripstop silk, polyester/Lycra panels		
	ASILKCS Hood	Mummy (Hood)	210 x 92cm	132g			
	ASILKCSLONG	Long		145g			
	ASILKCSMUMMY	Mummy (Tapered)	185 x 92cm	125g			
	ASILKCSSTD	Standard		130g			
	ASILKCSYHA	Traveller	225 x 92cm	154g			
COOLMAX® Adaptor	ACMAX	Mummy (Hood)	210 x 92cm	248g	Polyester		
	ACMAXYHA	Traveller	225 x 92cm	328g			

# SLEEPING MATS

There is one simple reason we design and construct sleeping mats the way we do: to give you a great night's sleep, night after night.

To achieve this, we have created innovative designs that are more comfortable, and we pioneered materials and manufacturing techniques that are measurably more reliable. You may not see the results of the countless nights we spent working on the mats, but you can rest easy knowing that we achieved our goal.

Because a great sleep is the start to a great day.



# SLEEPING MATS (AIR SPRUNG CELL) OVERVIEW



PRODUCT	Etherlight XT AIR	Etherlight XT INSULATED	Etherlight XT INSULATED	Etherlight XT INSULATED	Etherlight XT INSULATED	Ultralight AIR	Ultralight INSULATED	Ultralight INSULATED	Comfortlight INSULATED	Comfortlight INSULATED	Comfortplus INSULATED	ComfortplusXT INSULATED
	SINGLE LAYER DESIGN								HYBRID DESIGN		DUAL LAYER DESIGN	
SHAPE												
R-VALUE												



# Etherlight XT ○○○

## SINGLE LAYER DESIGN

**Ether** light XT AIR

**Ether** light XT INSULATED



AIR SPRUNG CELL

TPU LOOPS

30/40D Nylon



REFLECTS RADIANT HEAT



PREVENTS CONVECTIVE HEAT TRANSFER

Etherlite XT Insulated mats combine all the benefits of the Etherlite XT Air with the addition of:

**Our Etherlight Mat design creates a thicker mat, without increasing overall weight.**



The innovative Ether Light Air Sprung Cell construction brings stability and comfort to the world of thicker air mats, while reducing overall weight. Enjoy a plush sleeping experience, regardless of the position you sleep in.

Ether light XT  
AIR



R-value  
ASTM F3340-18  
**1.2**

Thickness  
**10cm | 4in**

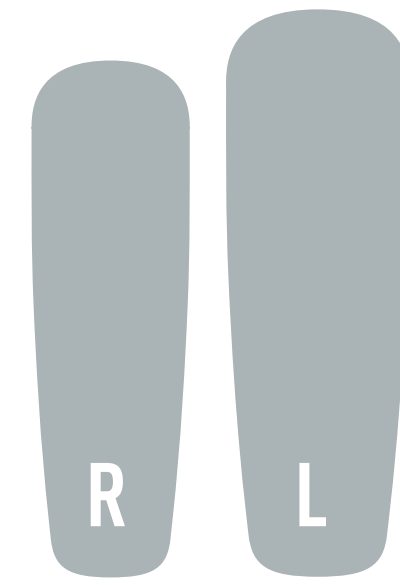

Ether light XT  
INSULATED



R-value  
ASTM F3340-18  
**3.2**

Thickness  
**10cm | 4in**

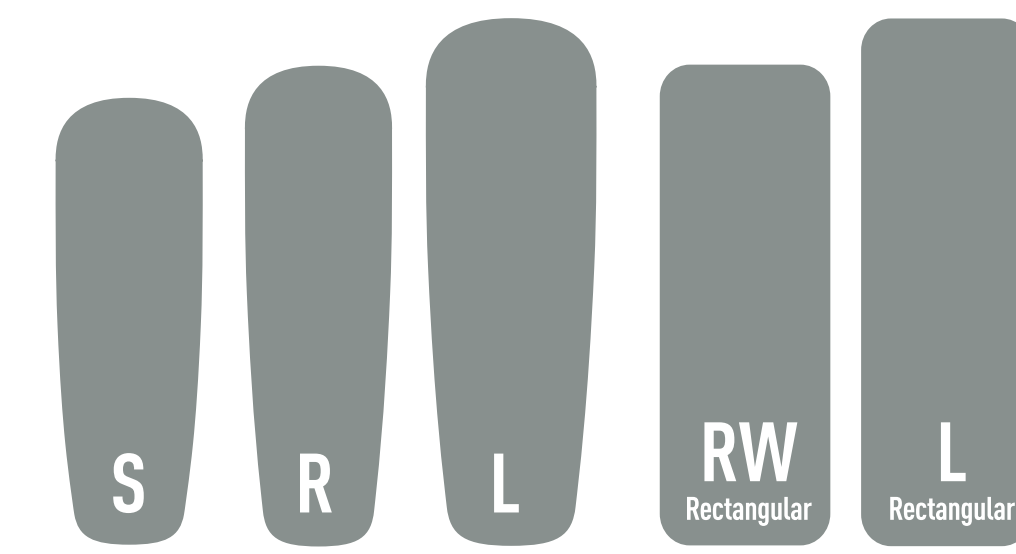

Exkin® PLATINUM  
**THERMOLITE®**

Ether light XT  
INSULATED



R-value  
ASTM F3340-18  
**3.5**

Thickness  
**10cm | 4in**

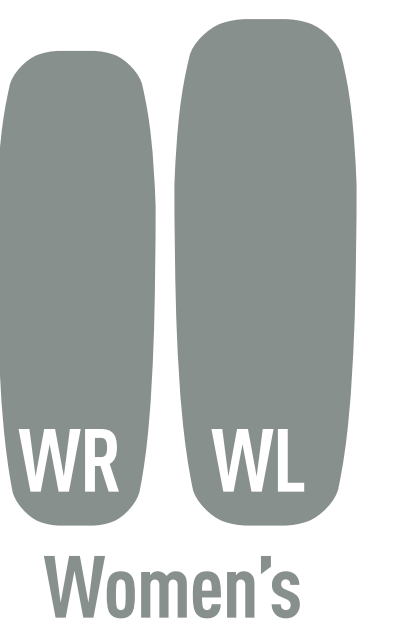

Exkin® PLATINUM  
**THERMOLITE®**



# Etherlight XT EXTREME

## SINGLE LAYER DESIGN

Ether Light XT EXTREME

Ether Light XT EXTREME

Extra Thick  
and Extra Warm.

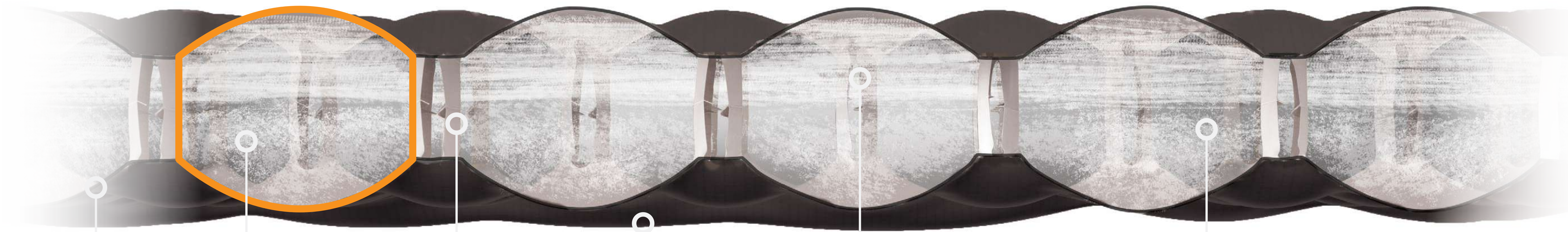

AIR SPRUNG CELL

TPU LOOPS

30/40D Nylon

**THERMOLITE**

PREVENTS CONVECTIVE HEAT TRANSFER +

THERMOLITE HIGH LOFT BOTTOM LAYER



Designed with extreme conditions in mind, our unique 'dual-density' Thermolite insulation minimizes both internal convection and internal air movement, making the Ether Light Extreme suitable for use in very cold environments.

Ether light XT  
EXTREME



R-value  
6.2  
ASTM F3340-18

Thickness  
10cm | 4in

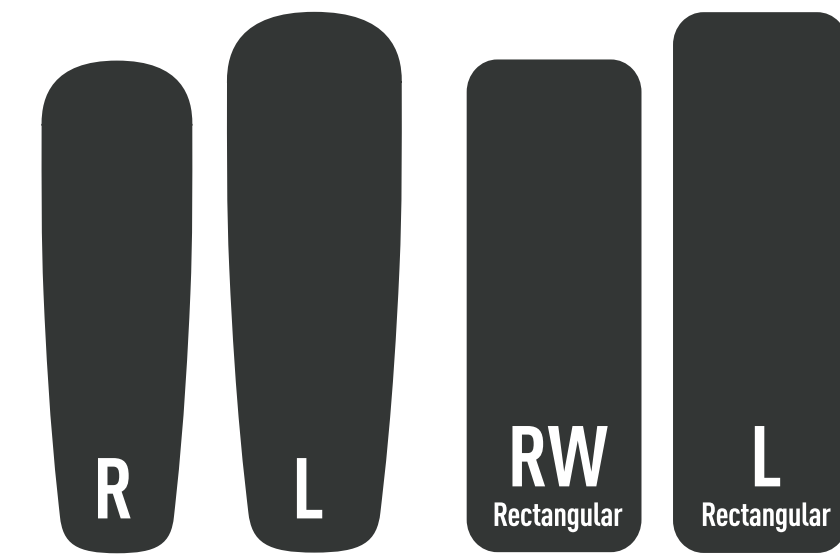

THERMOLITE



Ether light XT  
EXTREME



R-value  
6.3  
ASTM F3340-18

Thickness  
10cm | 4in

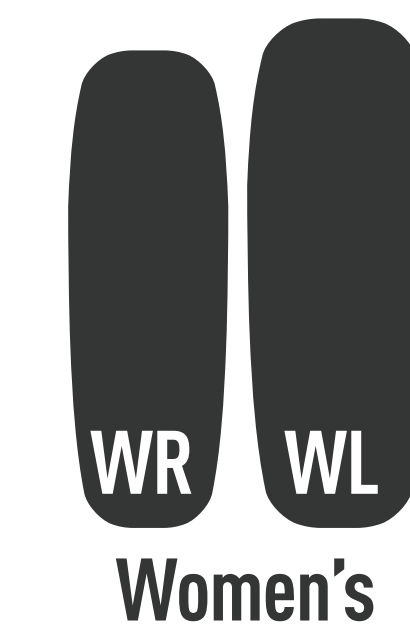

THERMOLITE





# Ultra light ○○○

## SINGLE LAYER DESIGN

**Ultra light** AIR

**Ultra light** INSULATED



A single layer of medium resolution cells for minimal packed size and weight.



The Ultralight series combines Air Spring Cell stability, Sea to Summit durability, and low overall weight. If you need a mat that will provide a generous level of comfort at a modest weight, look no further.



Ultralight



Ultralight Insulated

Ultra light AIR



R-value **1.1**  
ASTM F3340-18

Thickness **5cm | 2 in**



Ultra light INSULATED



R-value **3.1**  
ASTM F3340-18

Thickness **5cm | 2 in**



Exkin<sup>®</sup> PLATINUM

THERMOLITE<sup>®</sup>

Ultra light INSULATED



R-value **3.5**  
ASTM F3340-18

Thickness **5cm | 2 in**

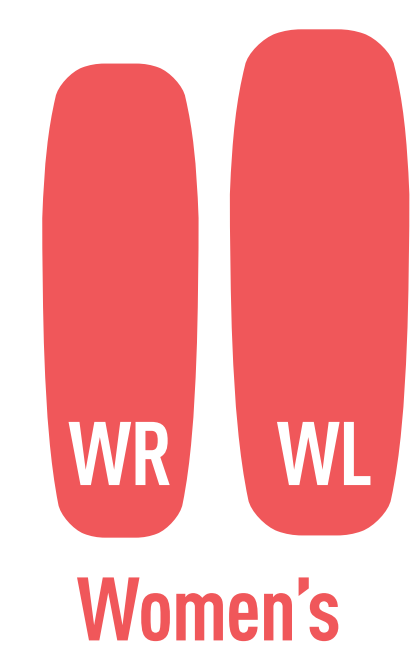

Exkin<sup>®</sup> PLATINUM

THERMOLITE<sup>®</sup>





# Comfort light

## HYBRID LAYER DESIGN

**Comfort light** INSULATED

**Comfort light** INSULATED



A double layer of high resolution cells in the torso for increased comfort, with a single layer of medium resolution cells in the head and legs for reduced weight.





The Comfort-Light mat uses a hybrid design that offers additional warmth and comfort, without a substantial increase in weight or bulk.



Comfort light Insulated

Comfort light  
INSULATED



R-value  
3.7  
ASTM F3340-18  
Torso double layer zone

Thickness  
6.3cm | 2½ in



Exkin® PLATINUM

THERMOLITE®



Comfort light  
INSULATED



R-value  
3.9  
ASTM F3340-18  
Torso double layer zone

Thickness  
6.3cm | 2½ in



Exkin® PLATINUM

THERMOLITE®





# Comfort plus

## DUAL LAYER COMFORT

Comfort **plus** INSULATED

Comfort **plus XT** INSULATED

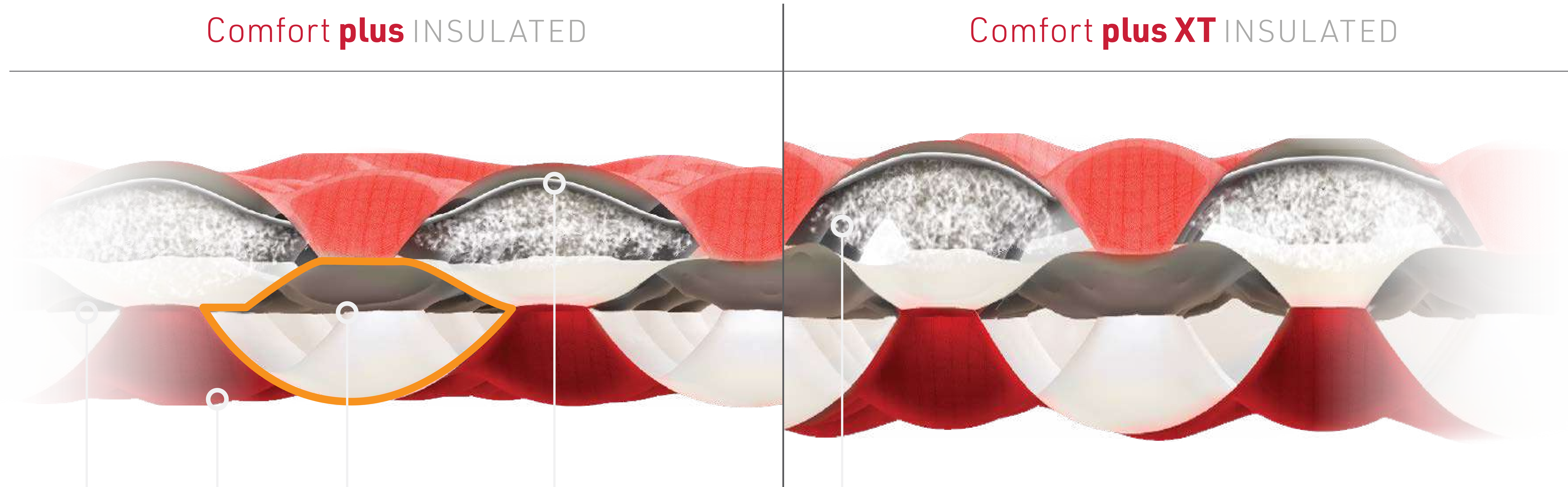

30/40D Nylon

AIR SPRUNG CELL



Comfort plus XT Insulated mats combine all the benefits of the Comfort plus Insulated but are extra thick.

Two layers of high resolution cells for all-over comfort and security-independent chambers allow the mat to function even if one layer is punctured.



The dual chamber design of the Comfort-Plus offers a more stable and comfortable platform than any other lightweight sleeping mat available.



Comfort Plus Insulated

**Comfort plus**  
INSULATED



R-value **4.0**  
ASTM F3340-18

Thickness  
**6.3cm | 2½ in**



**Exkin** PLATINUM

**THERMOLITE**



**Comfort plusXT**  
INSULATED

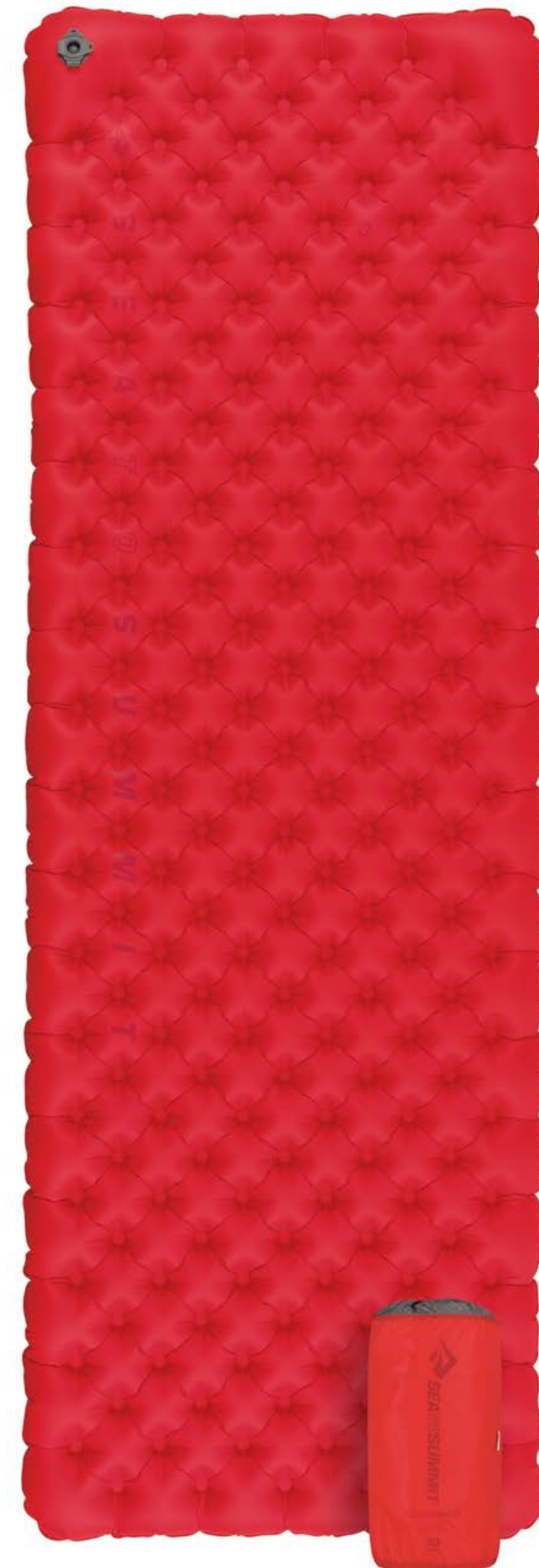

R-value **4.7**  
ASTM F3340-18

Thickness  
**8cm | 3 in**



**Exkin** PLATINUM

**THERMOLITE**





## ETHERLIGHT XT

PRODUCT NAME	CODE	SIZE	DIMENSIONS	PACKED DIMENSIONS	WEIGHT	COLOUR	RRP
Ether Light XT	AMELXTR	Regular	183 x 55cm	ø9 x 19cm			
	AMELXTL	Large	198 x 64cm	ø10 x 22cm	500g		
Ether Light XT Insulated	AMELXTINS_S	Small	168 x 55cm	ø11 x 24cm	470g		
	AMELXTINS_R	Regular	183 x 55cm		490g		
	AMELXTINS_L	Large	198 x 64cm	ø13 x 28cm	625g		
	AMELXTINS_RRW	Rectangular Reg. Wide	183 x 64cm	ø11 x 24cm	690g		
	AMELXTINS_RL	Rectangular Large	201 x 64cm	ø12 x 28cm	630g		
Ether Light XT Insulated Women's	AMELXTINS_WR	Regular	168 x 55cm	ø11 x 24cm	495g		
	AMELXTINS_WL	Large	183 x 64cm	ø12 x 28cm	600g		

## ETHERLIGHT XT EXTREME

PRODUCT NAME	CODE	SIZE	DIMENSIONS	PACKED DIMENSIONS	WEIGHT	COLOUR	RRP
Ether Light XT Extreme	AMELXTEXMR	Regular	183 x 55cm	ø17.5 x 24cm	720g		
	AMELXTEXML	Large	198 x 64cm	ø18.5 x 28cm	950g		
	AMELXTEXMRRW	Rectangular Reg. Wide	183 x 64cm		1050g		
	AMELXTEXMRL	Rectangular Large	201 x 64cm				
Ether Light XT Extreme Women's	AMELXTEXMWR	Regular	168 x 55cm	ø17.5 x 24cm	685g		
	AMELXTEXMWL	Large	183 x 64cm	ø18.5 x 28cm	870g		



## ULTRALIGHT

PRODUCT NAME	CODE	SIZE	DIMENSIONS	PACKED DIMENSIONS	WEIGHT	COLOUR	RRP
	AMULSAS	Small	168 x 55cm	ø7 x 17cm	345g		
Ultralight Mat	AMULRAS	Regular	183 x 55cm	ø7.5 x 17cm	395g		
	AMULLAS	Large	198 x 64cm	ø7.5 x 20cm	495g		
	AMULINS_XS	X Small	128 x 55cm	ø9 x 23cm	349g		
UltraLight Insulated Mat	AMULINS_S	Small	168 x 55cm	ø9.5 x 23cm	430g		
	AMULINS_R	Regular	183 x 55cm	ø10 x 23cm	480g		
	AMULINS_L	Large	198 x 64cm	ø10.5 x 26cm	595g		
UltraLight Insulated Mat Women's	AMULINS_WR	Regular	168 x 55cm	ø9.5 x 23cm	480g		
	AMULINS_WL	Large	184 x 64cm	ø10 x 23cm	580g		



### COMFORT LIGHT INSULATED

PRODUCT NAME	CODE	SIZE	DIMENSIONS	PACKED DIMENSIONS	WEIGHT	COLOUR	RRP
Comfort Light Insulated Mat	AMCLINS_S	Small	168 x 55cm	ø12 x 24cm	590g		
	AMCLINS_R	Regular	184 x 55cm	ø13.5 x 24cm	640g		
	AMCLINS_L	Large	201 x 64cm	ø13.5 x 27cm	755g		
Comfort Light Insulated Women's	AMCLINS_WR	Regular	168 x 55cm	ø13 x 24cm	585g		
	AMCLINS_WL	Large	183 x 64cm	ø13 x 27cm	715g		

### COMFORT PLUS INSULATED

PRODUCT NAME	CODE	SIZE	DIMENSIONS	PACKED DIMENSIONS	WEIGHT	COLOUR	RRP
Comfort Plus Insulated Mat	AMCPINS_R	Regular	184 x 55cm	ø14.5 x 24cm	845g		
	AMCPINS_L	Large	201 x 64cm	ø14.5 x 27cm	1045g		
Comfort Plus XT Insulated	AMCPXTINS_RRW	Rectangular Reg. Wide	183 x 64cm	ø17.5 x 28cm	1185g		
	AMCPXTINS_RL	Rectangular Large	201 x 64cm	ø17 x 28cm	1295g		



# AIR SPRUNG CELL MATS

Our award-winning Air Sprung Cell Sleeping Mats provide air cushioned comfort from the lumps and bumps beneath you.

## COMFORTABLE



### AIR SPRUNG CELLS

Stability equals greater comfort. A pattern of dot-welds creates hundreds of interconnected chambers called Air Sprung Cells. Just like a pocket spring mattress, this matrix of cells provides unmatched support while conforming to the contours of the sleeper.



### THERMOLITE® INSULATION

Designed for ultimate performance, THERMOLITE® is made from specially engineered fibres to achieve a high CLO value with low weight. The THERMOLITE® insulation lofts up inside the Air Sprung Cells to prevent convective heat loss from your warm body to the cold ground.



### EXKIN PLATINUM®

A very lightweight, quiet, non-woven fabric that has a thin metalised layer applied to the surface which reflects radiant heat back to the user.

## DURABLE



### EXTRUSION TPU LAMINATION

Ultra-Fresh® anti-microbial treatment added to the TPU formula prevents internal mould growth.

### DURABLE 30/40D NYLON FACE FABRIC

Lightweight, quiet and grippy 30/40D Nylon face fabric.

## EASY TO USE



### PILLOWLOCK SYSTEM

Pillow Lock attaches an Aeros pillow to mat.

### REPAIR KITS

All ASC Mats ship with a set of peel and stick repair patches that provide quick and permanent solutions to any unfortunate punctures.



### AIRSTREAM PUMPSACK

Includes an Airstream Pump that is integrated into the stuff sack for quick and easy inflation.

### MULTI-FUNCTION VALVE

Multi-function valve provides fast inflate, deflate and easy fine-tuning for personalised comfort.

# EXPLORE THE RANGE

	DELTA CORE-V			DELTA CORE					
	<b>Ultra light S.I.</b> SELF INFLATING 		<b>Camp mat S.I.</b> SELF INFLATING 	<b>Camp plus S.I.</b> SELF INFLATING 	<b>Comfort light S.I.</b> SELF INFLATING 		<b>Comfort plus S.I.</b> SELF INFLATING 		<b>Comfort deluxe S.I.</b> SELF INFLATING 
<b>R-Value</b> <small>ASTM F3340-18</small>	 2.6	 2.9	 4.2	 4.3	 3.1	 3.8	 4.1	 5.1	 6.5





Our lightest SI Mat that offers all of our class leading technology but with a minimal packed size.

**Ultra light S.I.**  
SELF INFLATING



R-value  
2.6  
ASTM F3340-18

Thickness  
2.5cm | 1 in



**Ultra light S.I.**  
SELF INFLATING



R-value  
2.9  
ASTM F3340-18

Thickness  
2.5cm | 1 in





The Camp Mat constructed with Delta V Core technology is a lightweight, durable, value oriented sleeping mat that offers all-season performance.

**Camp mat S.I.**  
SELF INFLATING



R-value **4.2**  
ASTM F3340-18

Thickness **3.8cm | 1½ in**



R L

VIDEO

The Camp Plus Mat offers plush comfort and extra warmth with Delta Core technology in a robust and durable design at a great value.

**Camp plus S.I.**  
SELF INFLATING



R-value **4.3**  
ASTM F3340-18

Thickness **7.5cm | 3in**



R L RW L  
Rectangular Rectangular

VIDEO

### DELTA CORE

Removes over 40% of the foam to reduce weight and bulk without compromising durability



### MULTI-FUNCTION SI VALVE

Flip-over multi-function valve for fast and easy inflation, deflation and fine-tuning of air pressure

### DURABILITY

Robust and abrasion resistant 75D polyester shell fabric with extrusion laminated TPU



The combination of lightweight fabrics and clever construction with Delta Coring technology provides 3 season warmth and extra comfort without adding extra weight or cost.

**Comfort light S.I.**  
SELF INFLATING

R-value **3.1**  
ASTM F3340-18

Thickness **5cm | 2 in**

S R L

VIDEO

**Comfort light S.I.**  
SELF INFLATING

R-value **3.8**  
ASTM F3340-18

Thickness **5cm | 2 in**

WR WL  
Women's

VIDEO





The Comfort Plus SI mat offers 3 inches of plush foam luxury for life on the road. To enhance the already sumptuous level of comfort, the upper surface features a stretch-knitted fabric. The series includes tapered, rectangular, double and also women's-specific models, all suitable for extended-season camping.

**Comfort plus S.I.**  
SELF INFLATING

R-value **4.1**  
ASTM F3340-18

Thickness **8cm | 3 1/8 in**

RW Rectangular, L, D, R, L

VIDEO

**Comfort plus S.I.**  
SELF INFLATING

R-value **5.1**  
ASTM F3340-18

Thickness **8cm | 3 1/8 in**

WR, WL Women's

VIDEO

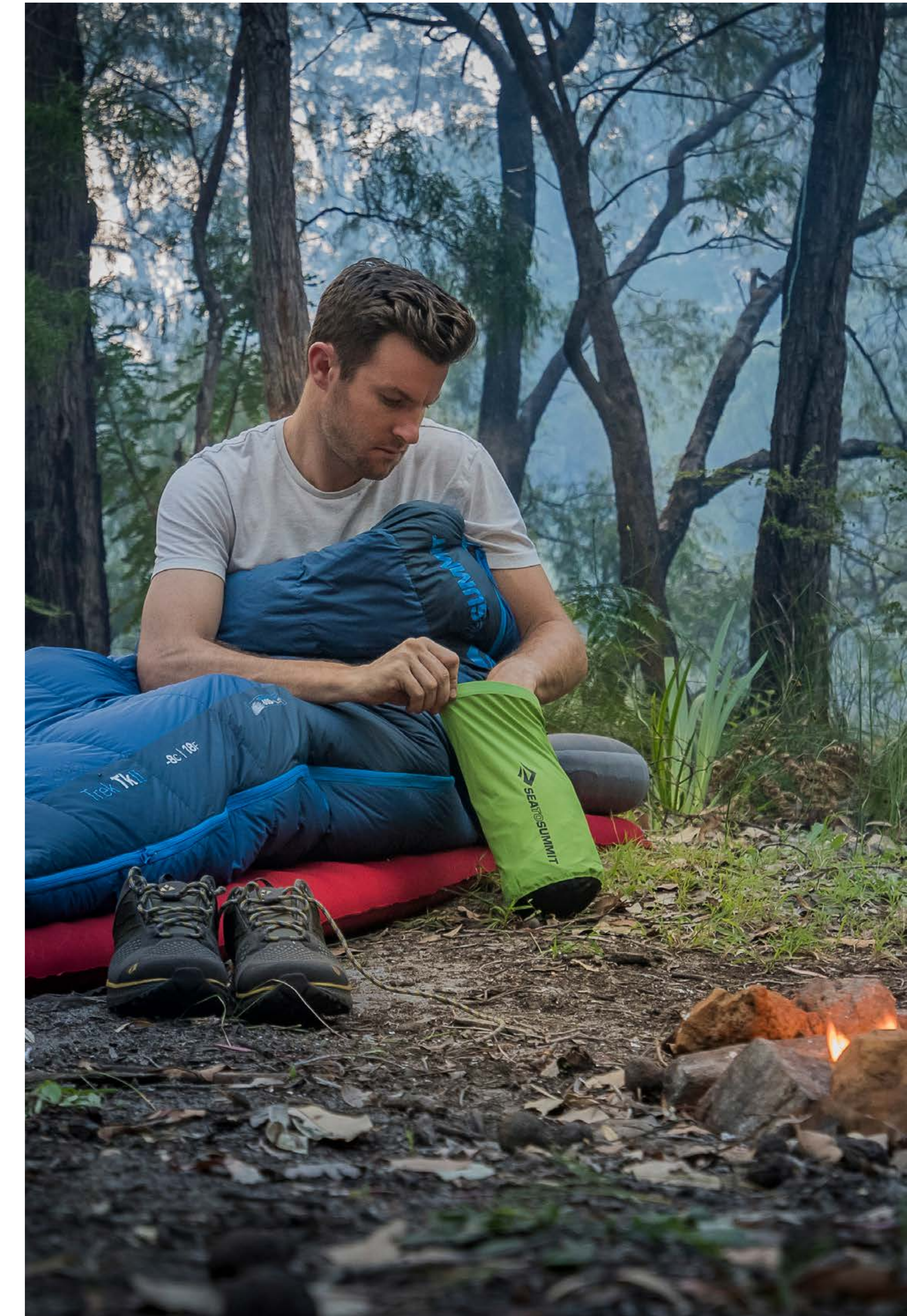



The ultimate in luxury for overlands and van lifers, the 4 inch thick Comfort Deluxe SI brings the comfort of home to wherever your travels take you. The stretch-knit upper surface is simply luxurious.

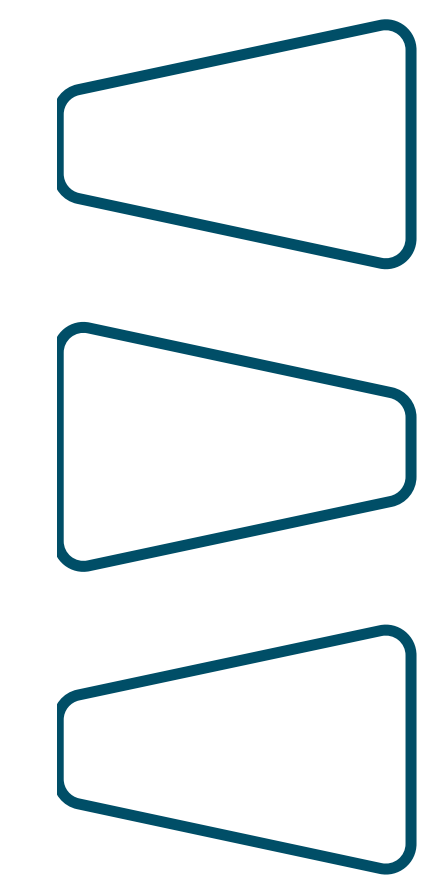

Comfort deluxe S.I.  
SELF INFLATING



R-value  
6.5  
ASTM F3340-18

Thickness  
10cm | 4 in

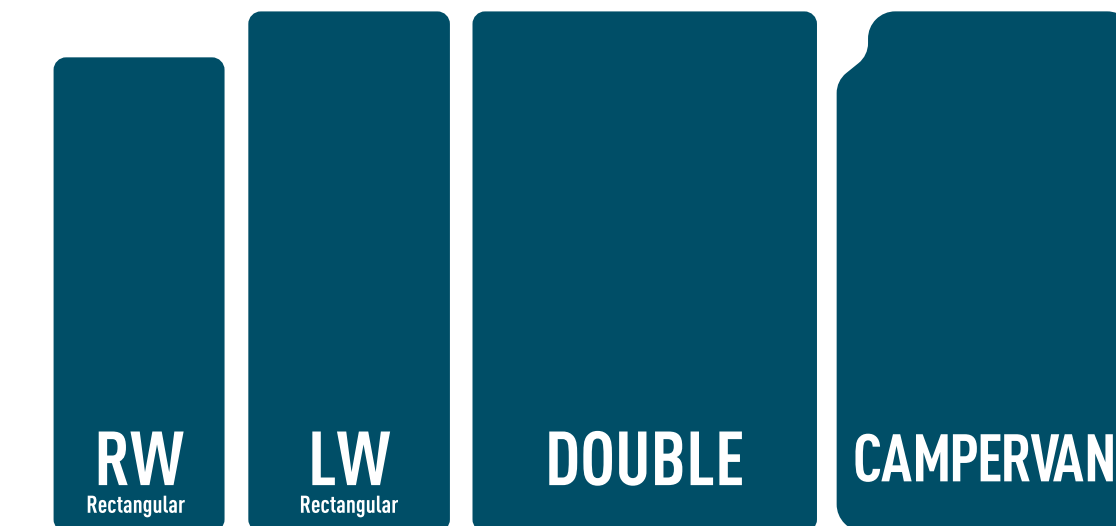

# SELF-INFLATING MATS

Our range of self-inflating mats provide consistent warmth along the full length of the mat in a compact and lighter, comfortable, easy-to-use package.

## COMFORT



### PILLOWLOCK SYSTEM

Pillow Lock attaches an Aeros pillow to mat.

### FOUR WAY STRETCH FABRICS

Four way stretch fabrics better conform to your body as you sleep.

### ANTI-SLIP SILICONE PRINT

Prevents your sleeping bag from slipping on the mat, or the mat from slipping on the tent floor.

## EASE OF USE

### REPAIR KITS

Both our Self Inflating and Air Sprung Cell mats include a small repair kit with repair patches.

### MULTI-FUNCTION REVERSIBLE VALVE

Specifically designed for Self-Inflating mats.

With a simple twist, our multi-function valve prevents reinflation while rolling your mat up. Twist it back for easy one-way inflation and fine tuning.

## LIGHTER WEIGHT

### DELTA CORE

The design leaves a solid layer of foam to bond with the fabric across the full length of the mat, making a far more durable finish.

Delta Core design leaves extra foam directly under the sleeper, providing better insulation.



### DELTA CORE-V

In our lighter models, Delta Core-V vertical coring technology is applied to remove 20% of the weight and bulk of the mat's polyurethane (PU) foam. We use sophisticated pressure-mapping data to define body contact areas which becomes the blueprint for our distinctive graduated core pattern.



DELTA CORE

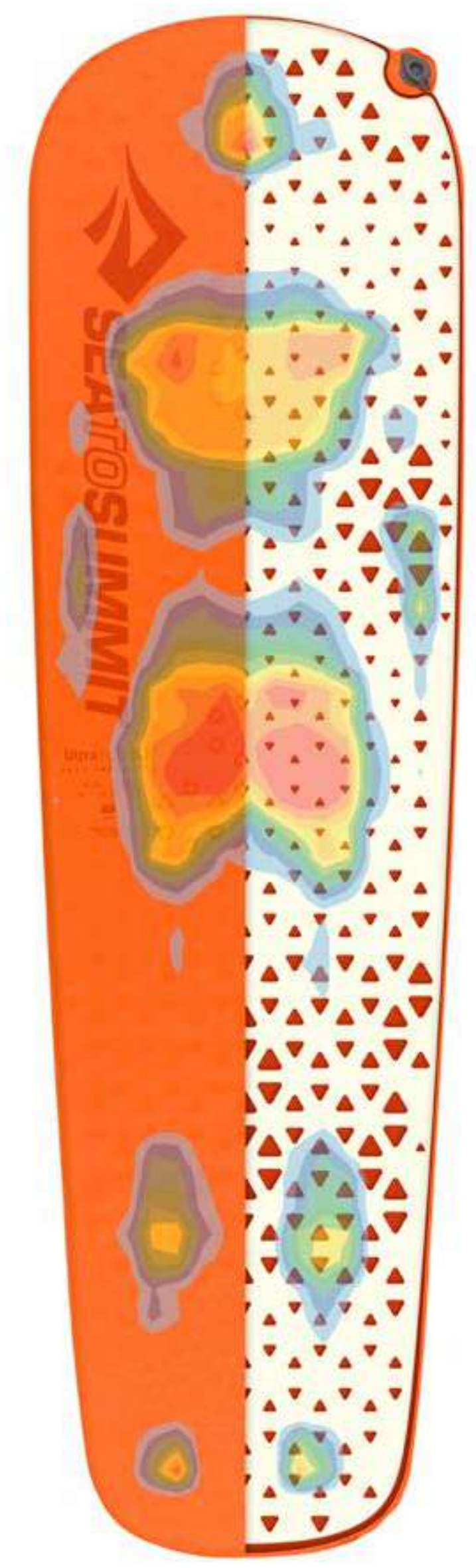

DELTA CORE-V



### ULTRALIGHT S.I.

PRODUCT NAME	CODE	SIZE	DIMENSIONS	PACKED DIMENSIONS	WEIGHT	COLOUR	RRP
Ultralight SI	AMSIULXS	X Small	125 x 51cm	ø10.5 x 26cm	395g		
	AMSIULS	Small	170 x 51cm	ø13 x 26cm	520g		
	AMSIULR	Regular	183 x 51cm	ø13.5 x 26cm	550g		
	AMSIULL	Large	198 x 64cm	ø14 x 13cm	720g		
Ultralight SI Women's	AMSIULWR	Regular	170 x 53cm	ø14 x 27cm	545g		
	AMSIULWL	Large	183 x 53cm	ø14.6 x 30cm	645g		

### CAMP MAT S.I.

PRODUCT NAME	CODE	SIZE	DIMENSIONS	PACKED DIMENSIONS	WEIGHT	COLOUR	RRP
Camp Mat SI	AMSIUMR	Regular	183 x 51cm	ø18.5 x 26cm   ø6 x 10 in	780g		
	AMSIUML	Large	198 x 64cm	ø19.7 x 33cm	1020g		
	AMSIUMRRW	Rect. Reg Wide	183 x 64cm	ø19.7 x 34cm	1115g		
	AMSIUMRL	Rect. Large	198 x 64cm	ø20.4 x 34cm	1180g		
Camp Plus SI	AMSIUMPLR	Regular	183 x 51cm	ø20.4 x 26cm	880g		
	AMSIUMPLL	Large	198 x 64cm	ø21.6 x 33cm	1185g		
	AMSIUMPLRRW	Rect. Reg Wide	183 x 64cm	ø20.4 x 34cm	1220g		
	AMSIUMPLRL	Rect. Large	201 x 64cm	ø21.6 x 34cm	1355g		



### COMFORT LIGHT S.I.

PRODUCT NAME	CODE	SIZE	DIMENSIONS	PACKED DIMENSIONS	WEIGHT	COLOUR	RRP
Comfort Light SI	AMSICLS	Small	170 x 51cm	ø14.5 x 26cm	595g		
	AMSICLR	Regular	183 x 51cm	ø15.3 x 26cm	650g		
	AMSICLL	Large	198 x 64cm	ø16.5 x 33cm	880g		
Comfort Light SI Women's	AMSICLWR	Regular	170 x 53cm	ø16.5 x 27cm	665g		
	AMSICLWL	Large	183 x 58cm	ø17.8 x 30cm	775g		

### COMFORT PLUS S.I.

PRODUCT NAME	CODE	SIZE	DIMENSIONS	PACKED DIMENSIONS	WEIGHT	COLOUR	RRP
Comfort Plus SI	ASM2067-01051908	Regular	183 x 51cm	ø19.1 x 26cm	970g		
	ASM2067-01061909	Large	198 x 64cm	ø20.4 x 33cm	1300g		
	ASM2067-01321911	Rect. Large	201 x 64cm	ø21.6 x 34cm	1470g		
	ASM2067-01291910	Rect. Regular Wide	183 x 64cm		1380g		
	ASM2067-01221912	Double	183 x 128cm	ø24.8 x 66cm	2635g		
Comfort Plus SI Women's	ASM2067-05331513	Regular	170 x 53cm	ø20.4 x 27cm	950g		
	ASM2067-05341514	Large	183 x 58cm	ø21.6 x 30cm	1130g		

### COMFORT DELUXE S.I.

PRODUCT NAME	CODE	SIZE	DIMENSIONS	PACKED DIMENSIONS	WEIGHT	COLOUR	RRP
Comfort Deluxe SI	ASM2065-01291605	Regular Wide	183 x 64cm	ø20.4 x 64cm	1995g		
	ASM2065-01461606	Large Wide	201 x 76cm	ø22.3 x 76cm	2645g		
	ASM2065-01221607	Double	201 x 132cm	ø32.5 x 65cm	4445g		
	ASM2065-01361608	Camper Van	201 x 115cm	ø30 x 60cm	3650g		





### MAT COUPLER KIT LOOPS

Stop sleeping in the crack—secure your two Sea to Summit mats together.

#### FEATURES

- Simple to use
- Low profile design stays flat for comfortable positioning



### AIRSTREAM PUMP SACK

Storage by day, pump by night—inflate your air mat in seconds.

#### FEATURES

- Works with the multi-function valve on both ASC and SI mats.

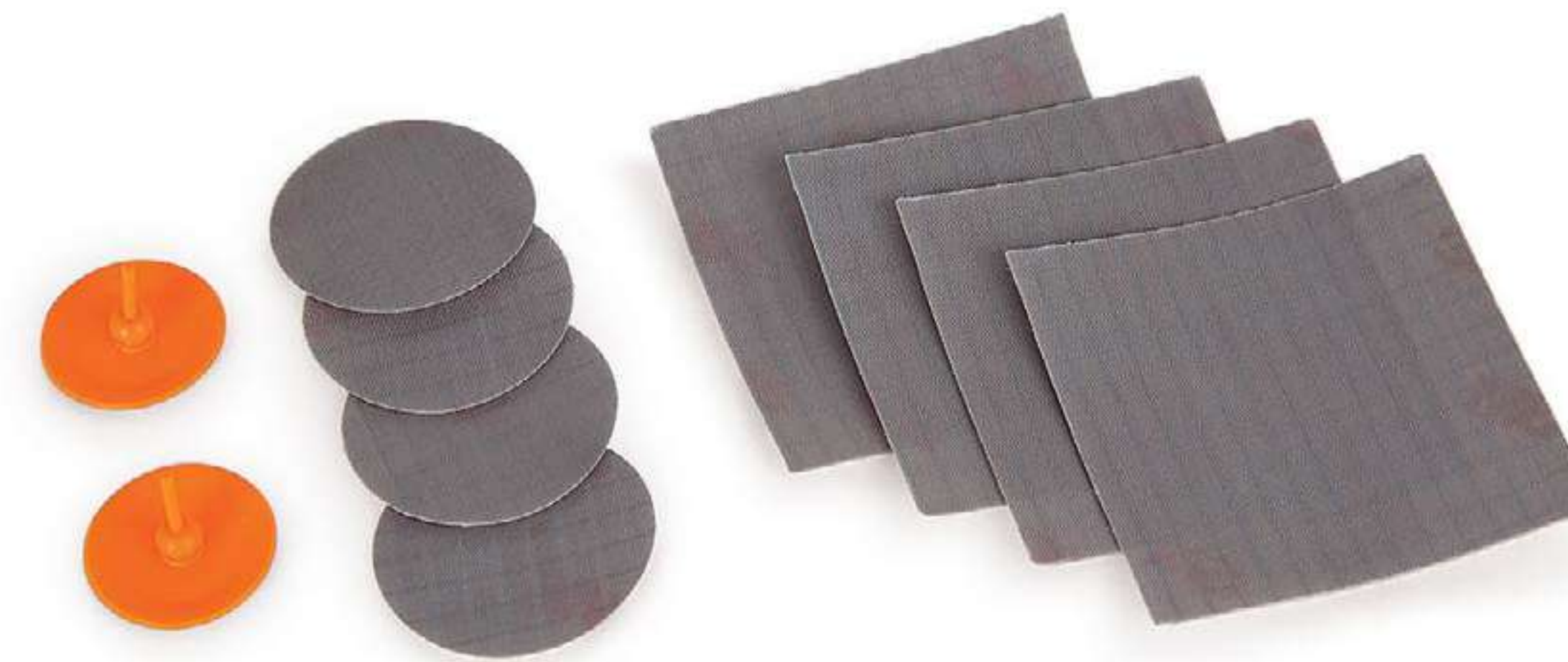

### AIR MAT REPAIR KIT

Punctures happen—repair your Sea to Summit air mat with ease.





## AIR CHAIR

Air mat transformer: chair by day and sleeping mat by night

### FEATURES

- Converts your Sea to Summit Sleeping Mat into a comfortable camp chair
- Reinforced pole sleeve with puncture-proof synthetic rubber caps for added strength
- Upgraded side release Field Repair Buckles with stainless steel pin on side straps for durability and high break-strength
- Durable 70D base with 2000mm waterhead protects your mat from rough or wet ground



SIZES R / L COLOUR



## AIR SEATS

So packable you won't notice the addition to your bag, but so useful you'll never leave home without it. Our Air Seat is the perfect way to add a little comfort to whatever you're sitting on. Available in both a standard and an insulated version.

### FEATURES

- Super-fast inflate and deflate with our multi-function low profile mini-valve



COLOURS



## S.I. SEAT

A compact seat companion that quickly inflates to provide extra comfort and support for any adventure.

### FEATURES

- Our patented low-profile multi-function mini-valve provides fast inflate, deflate and easy fine-tuning



COLOURS





### SLEEPING MAT ACCESSORIES

PRODUCT NAME	CODE	SIZE	DIMENSIONS	WEIGHT	MATERIALS	RRP
Airstream Pump Sack	AMASD		63 x 26 x 20cm	62g	15D PU-coated, siliconised Nylon	
Mat Coupler Kit Loops	AMCK		270 x 2cm	17g	Nylon	
Air Mat Repair Kit	AMRK		5 x 5cm	10g	100% Nylon, 3M glue	
Air Chair	AMAIRCR	Regular	53 x 45cm	253g	70D PU-coated Nylon, 30D PU-coated, siliconised CORDURA® Nylon	
	AMAIRCL	Large	60 x 48cm	260g		

### SEATS









PRODUCT NAME	CODE	DIMENSIONS	COLLAPSED DIMENSIONS	WEIGHT	COLOUR	RRP
Air Seat	AMAS	38 x 28 x 6cm	12 x 10 x 3cm	70g		
Air Seat Insulated	AMASINS			80g		
Self Inflating Seat	AMSIDS	40 x 30 x 3.8cm	ø7.5 x 17cm	104g		

# PILLOWS

Ultralight pillows to help you sleep better.



# EXPLORE THE RANGE

AEROS PILLOWS			FOAM PILLOWS
<p><b>PREMIUM</b></p>  <p>AEROS PREMIUM DELUXE</p>  <p>AEROS PREMIUM</p>  <p>AEROS PREMIUM TRAVELLER</p>  <p>AEROS PREMIUM LUMBAR SUPPORT</p>	<p><b>ULTRALIGHT</b></p>  <p>AEROS ULTRALIGHT DELUXE</p>  <p>AEROS ULTRALIGHT</p>  <p>AEROS ULTRALIGHT TRAVELLER</p>	<p><b>DOWN</b></p>  <p>AEROS DOWN</p>	 <p>FOAM CORE PILLOW</p>



# AEROS PILLOWS

Whether in transit or the back country, our Aeros range of lightweight and compact inflatable pillows will award you a comfortable sleep.

## OUR AEROS PILLOWS FEATURE:

### PILLOWLOCK COMPATIBLE

Easily secure your Aeros pillow to your Sea to Summit mat for a slip-free sleep—PillowLock patches are included with all our mats.

### MULTI-FUNCTION MINI VALVE

Featuring our unique mini-valve for easy inflation, deflation and fine tuning.

### LIGHTWEIGHT AND COMPACT

Often forgotten, always appreciated—they're so small and light the only decision to make is which one to choose.

### CONVENIENT STORAGE

Comes with a stuff sack or zippered pouch to make packing and storage so much easier.





# AEROS PREMIUM

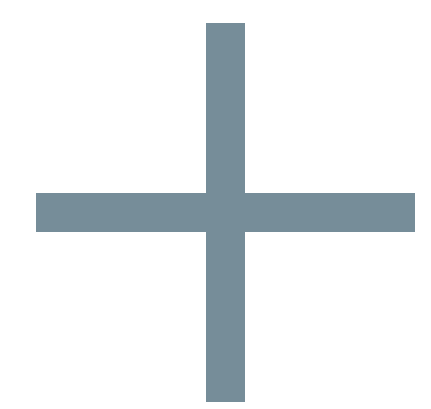

## OUR AEROS PREMIUM RANGE FEATURES:

### LUXURIOUS FEEL

Brushed, 50D polyester, stretch-knit face fabric for soft hand feel.

### COMFORTABLE

Synthetic fill between pillow case and TPU bladder increases comfort and wicks away perspiration.



## AEROS PREMIUM DELUXE

Dream big; pack small with this luxurious, lightweight and surprisingly compact full-size pillow.



## AEROS PREMIUM

A luxurious, high-performance pillow without the weight and bulk. Perfect for travel and camping where you can risk a couple more grams for a great night's sleep.

### FEATURES

- Scalloped bottom edge centres the pillow over your shoulder no matter whether you are sleeping on your back, side or sitting upright in a chair





## AEROS PREMIUM TRAVELLER

Take your transit comfort to a new level with our packable Premium Traveller Pillow.

### FEATURES

- Adjustable neck closure for additional support
- Ergonomic shape and enlarged ends reduce the need to bend your neck for support
- Narrows at the centre to fit snugly between your neck and headrest

COLOURS



VIDEO



## AEROS PREMIUM LUMBAR SUPPORT

Keep your lower back supported and comfortable in the air, at your desk or behind the wheel.

### FEATURES

- Includes an adjustable webbing strap to secure the pillow in place

COLOURS







# AEROS ULTRALIGHT

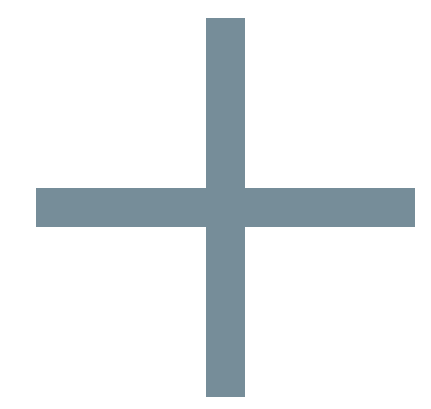

## OUR AEROS ULTRALIGHT RANGE FEATURES:

### LIGHT AND COMPACT

Made from 20D laminated polyether to be very light and compact.

### DURABLE

Laminated with abrasion-resistant high strength TPU with durable RF-welded construction.

### QUICK AND EASY

Inflate pillow in a couple of breaths with the multi-function mini-valve.

### COMFORTABLE

Stretch-knit fabric creates a more comfortable user experience.



## AEROS ULTRALIGHT DELUXE

Extremely comfortable, lightweight and surprisingly compact full-size pillow.

COLOURS



## AEROS ULTRALIGHT

Light, compact and comfortable support –the best 60g you'll ever add to your pack.

### FEATURES

- Scalloped bottom edge centres pillow over your shoulders whether sleeping on your back, side, or upright in a chair

SIZES R / L

COLOURS





## AEROS ULTRALIGHT TRAVELLER

Add a little extra comfort to our next transit with this ultralight neck pillow.

### FEATURES

- Adjustable neck closure for additional support
- Ergonomic shape and enlarged ends reduce the need to bend your neck for support
- Narrows at the centre to fit snugly between your neck and headrest

COLOURS



## AEROS DOWN

Light, warm and comfortable, our Aeros Down Pillow is the lightest fully-featured down pillow on the market.

### FEATURES

- Premium down cushion-top for comfort and warmth

SIZES R / L / DLX

COLOURS





## FOAM CORE PILLOW

Compact comfort for the outdoors, our Foam Core Pillow offers the traditional feel of your favourite pillow at home. Firmly stuffed with upcycled foam off-cuts from our SI Sleeping Mats, our Foam Core Pillow is compressed and stored with a simple hook-and-loop fastener. Styled to perform just like your favourite pillow at home, our Foam Core Pillow is the perfect compact camp pillow.

### FEATURES

- Compresses to less than 20% of its maximum size

SIZES R / L / DLX

COLOURS  

 VIDEO 



Handy integrated pocket



Stuffed with upcycled foam off-cuts



Rolling hook-and-loop closure





## AEROS PREMIUM PILLOWS

PRODUCT NAME	CODE	SIZE	DIMENSIONS	COLLAPSED DIMENSIONS	WEIGHT	MATERIALS	PILLOWLOCK COMPATIBLE	COLOUR	RRP
Aeros Premium Deluxe	APILPREMDLX	Deluxe	36 x 56 x 14cm	12 x 11 x 5.5cm	195g	50D polyester knit fabric, TPU bladder, polyfill under contact surface			
Aeros Premium	APILPREMR	Regular	34 x 24 x 11cm	ø7 x 8.5cm	79g				
	APILPREML	Large	42 x 30 x 13cm	ø8 x 10.5cm	114g				
Aeros Premium Traveller	APILPREMYHA	Traveller	39 x 29 x 11cm	9 x 7 x 4.5cm	93g				
Aeros Premium Lumbar Support	APILPREMLMB	Lumbar	42 x 28 x 11cm	12.5 x 7.5 x 5cm	136g				

## AEROS ULTRALIGHT PILLOWS

PRODUCT NAME	CODE	SIZE	DIMENSIONS	COLLAPSED DIMENSIONS	WEIGHT	MATERIALS	PILLOWLOCK COMPATIBLE	COLOUR	RRP
Aeros Ultralight Deluxe	APILULDLX	Deluxe	36 x 56 x 14cm	12 x 10 x 3cm	130g	Laminated 20D polyester stretch knit and high strength TPU			
Aeros Ultralight	APILULR	Regular	36 x 26 x 12cm	ø5.5 x 7.5cm	60g				
	APILULL	Large	44 x 32 x 14cm	ø5.5 x 8.5cm	70g				
Aeros Ultralight Traveller	APILULYHA	Traveller	39 x 29 x 11cm	9 x 7 x 4.5cm	70g				



## AEROS DOWN

PRODUCT NAME	CODE	SIZE	DIMENSIONS	COLLAPSED DIMENSIONS	WEIGHT	MATERIALS	PILLOWLOCK COMPATIBLE	COLOUR	RRP
Aeros Down	APILDOWNR	Regular	34 x 24 x 12cm	ø6.5 x 8cm	70g	50D polyester knit fabric, TPU bladder, 10D Nylon upper face fabric, quality down filling			
	APILDOWNL	Large	42 x 28 x 12cm	ø7 x 9cm	95g				
	APILDOWNDLX	Deluxe	59 x 38 x 12cm	ø8 x 14cm	190g				

## FOAMCORE PILLOWS

PRODUCT NAME	CODE	SIZE	DIMENSIONS	COLLAPSED DIMENSIONS	WEIGHT	MATERIALS	PILLOWLOCK COMPATIBLE	COLOUR	RRP
FoamCore Pillow	APILFOAMR	Regular	34 x 24 x 13cm	ø10 x 27cm	220g	50D polyester knit fabric, polyfill under contact surface, PU foam			
	APILFOAML	Large	42 x 30 x 13cm	ø11 x 32cm	300g				
	APILFOAMD LX	Deluxe	56 x 36 x 15cm	ø12 x 37cm	450g				

# HAMMOCKS

Hang happy and free with our range of technical hammocks.



# EXPLORE THE RANGE

## HAMMOCK SETS



PRO  
HAMMOCK SET

## HAMMOCK ACCESSORIES

HAMMOCK TARP



HAMMOCK  
BUG NET



HAMMOCK  
TREE PROTECTOR

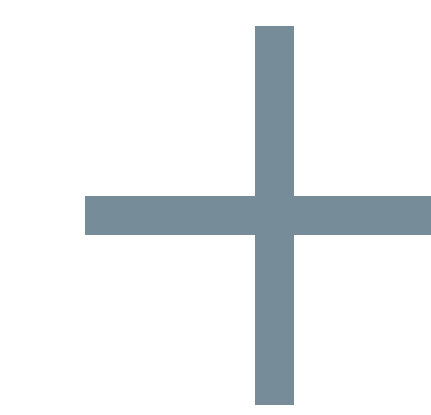

### OUR HAMMOCK SETS FEATURE:

#### STRONG AND DURABLE

Webbing loop bar-tacked five times at each end for added security.

#### LIGHTWEIGHT AND BREATHABLE

Highly breathable Nylon fabrics that are incredibly strong for their weight.

#### QUICK AND EASY

Quick-connect buckle system provides super fast set-up and adjustment.

#### CONVENIENT STORAGE

A water resistant compression sack made from 30D Ultra-Sil fabric for minimising space when packed away.

#### ALL-IN-ONE STORAGE

Suspension Straps are included with every set, and neatly pack away in the compression sack.

# HAMMOCK SETS

More compact in your pack, easier to pitch, more comfortable to sleep in. Our hammock sets feature an innovative suspension system with quick setup buckles, super-breathable fabrics, and built-in compression sacks.







## PRO HAMMOCK SET

The perfect hammock to take with you on globetrotting adventures or backcountry hikes.

SIZES SINGLE / DOUBLE

COLOURS   





**15D ULTRA-SIL**

### HAMMOCK TARP

Remain high and dry without adding excess weight or bulk to your lightweight and compact hammock setup.

FEATURES

- Five strong and durable tie-out points each hold the tip of a trekking pole
- Asymmetric design reduces weight while still providing multiple setup options

COLOURS



### HAMMOCK TREE PROTECTOR

Protect our environment with these easy-to-use hammock tree protectors.

FEATURES

- Compact and light: fits inside hammock compression bag
- Wider webbing spreads the weight of the hammock across a broader area, lessening the potential for damage to tree bark



### HAMMOCK BUG NET

Easy setup and effective protection from bugs for your hammock.

FEATURES

- Large right-angle zip opens wide for easy access
- Enjoy the view with high-visibility black mesh
- Uninterrupted star-gazing

TRIM COLOUR





## HAMMOCK SETS

PRODUCT NAME	CODE	SIZE	DIMENSIONS	COLLAPSED DIMENSIONS	WEIGHT	MATERIALS	COLOUR	RRP
Pro Hammock Set	AHAMSETS	Single	300 x 150cm	ø10 x 17cm	560g	70D ripstop Nylon fabric, high tenacity 15mm polyester webbing suspension straps, steel buckles		
	AHAMSETD	Double	300 x 150cm		670g			

## HAMMOCK ACCESSORIES

PRODUCT NAME	CODE	DIMENSIONS	COLLAPSED DIMENSIONS	WEIGHT	MATERIALS	COLOUR	RRP
Hammock Tarp	AHAMTARP	360 x 280cm	ø8 x 19cm	350g	15D PU coated, siliconised Nylon		
Hammock Bug Net	AHAMBUG	295 x 120 x 80cm	ø11 x 21cm	380g	Polyester mesh		
Hammock Tree Protector	AHAMTP	150 x 3.8cm	ø9.5 x 4cm	135g	Polyester webbing, steel buckles		

# CAMP KITCHEN





# CAMP KITCHEN

OVERLANDERS, THRU-HIKERS,  
BACKPACKERS – INVITE YOUR  
BUDS TO YOUR CAMP KITCHEN.  
YOUR TASTE BUDS, THAT IS.

## INNOVATIVE COOKWARE AND TABLEWARE

Our pots feature quality materials and innovative details to ignite your inner, outdoor gourmet. Pair them with our dinnerware – which doubles up as food prep products – and you have the basis of simple yet soul-satisfying camp meals.

## SUPPORTS LEAVE NO TRACE ETHICS

We're committed to Leave No Trace outdoor ethics. Our folding sinks and buckets make it easy to move and use water away from streams, while our clean-up kits and biodegradable soaps make food waste management simple and straightforward.

## FUNCTION-SPECIFIC MATERIALS

Our durable and innovative camp kitchen range is engineered for all outdoor adventures. Our clever functionality elevates them far beyond 'plastic camp tableware', to part and parcel of an integrated food preparation system.



CAMP CLEAN UP

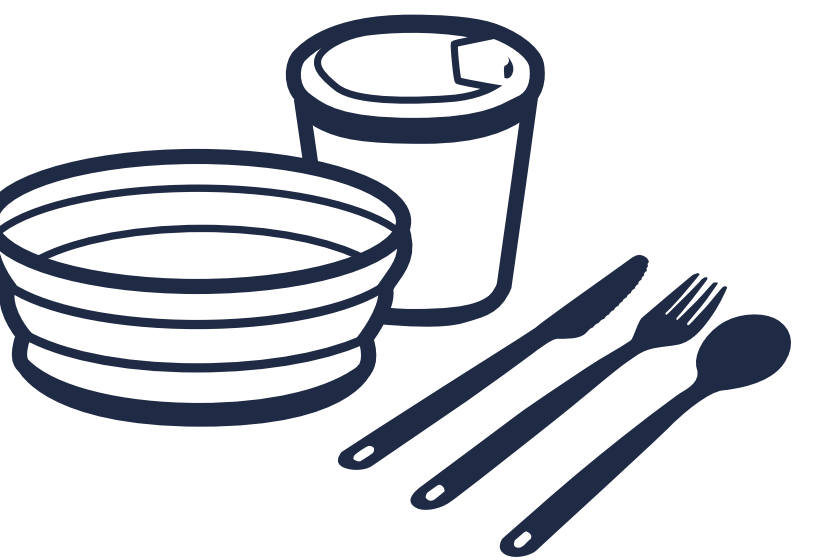

DINNERWARE

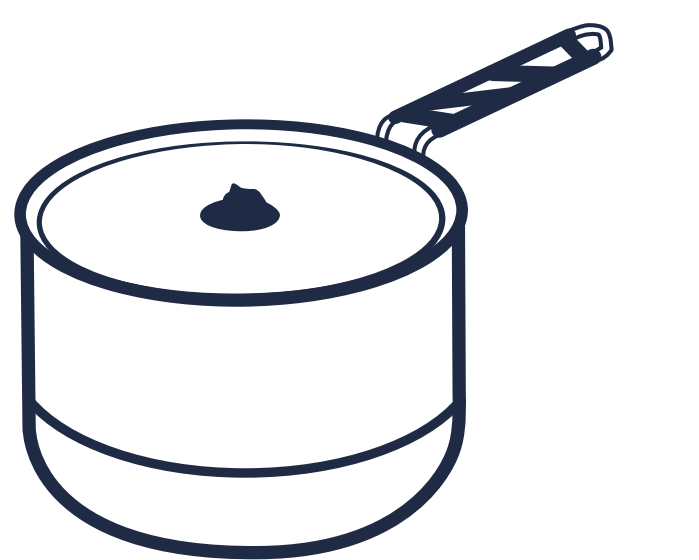

COOKWARE

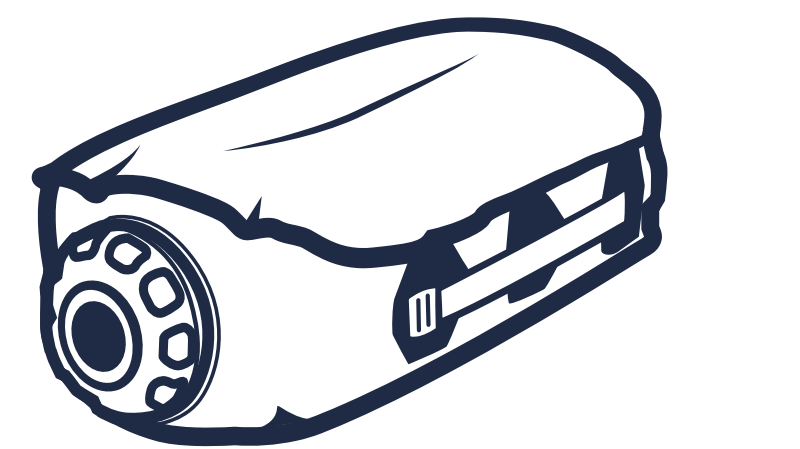

WATER TRANSPORT

# CAMP CLEAN UP

Often overlooked but essential to any camp kitchen system. Our range of camp kitchen clean up solutions make it easy to keep your camp clean and neat with minimal impact on the environment. Makes getting clean almost as much fun as getting dirty.





# EXPLORE THE RANGE

## CAMP CLEAN UP



CAMP KITCHEN  
POT SCRUBBER & SOAP



ULTRA-SIL  
KITCHEN SINK



ULTRA-SIL  
FOLDING BUCKET



TRASH  
DRY SACK



CAMP KITCHEN  
CLEAN-UP KIT



KITCHEN  
SINK



FOLDING  
BUCKET



### CAMP KITCHEN POT SCRUBBER & SOAP

Palm-sized polypropylene scrubber with Nylon bristles, an integrated scraper and 50ml bottle of our concentrated and biodegradable Wilderness Wash.

2 PIECE SET



### CAMP KITCHEN CLEAN-UP KIT

A convenient, lightweight all-in-one washing kit for your camp kitchen.

6 PIECE SET INCLUDES

- Pot Scrubber
- 50ml Wilderness Wash
- 10L Kitchen Sink
- Double sided Wash Cloth
- DryLite Dish Towel
- Nylon Zip Pouch







### ULTRA-SIL KITCHEN SINK

Small enough to fit in a pocket and light enough to barely leave a trace on a set of scales.

SIZES 10L

**30D ULTRA-SIL**



### KITCHEN SINK

Now you can take everything on your next camping adventure—including a collapsible Kitchen Sink that really works!

#### FEATURES

- Stainless steel stiffening ring prevents sink from tipping over or collapsing when full
- For use with hot water (up to 60°C) and detergent

SIZES 5L / 10L / 20L

**70D WATERPROOF FABRIC**





## ULTRA-SIL FOLDING BUCKET

Ultra-lightweight collapsible bucket for carrying water.

### FEATURES

- 10L capacity—ideal for transporting water back to camp
- Not freestanding

SIZES 10L

30D ULTRA-SIL



## TRASH DRY SACK

The outdoors is not a garbage can. Pack out your rubbish cleanly and neatly with this specially designed roll-top dry sack.

### FEATURES

- Waterproof, non-wicking roll-top closure for mess-free carrying
- Line with (biodegradable) garbage bag for easy cleaning and disposal
- Minimum garbage bag size: 40 x 60cm



70D WATERPROOF FABRIC



## FOLDING BUCKET

Completely collapsible lightweight yet durable free-standing bucket.

### FEATURES

- Free-standing on level surfaces
- Additional handle on base for easy pouring
- Fully welded construction

SIZES 10L / 20L







210D WATERPROOF FABRIC

420D WATERPROOF FABRIC





## CLEAN UP SOLUTIONS

PRODUCT NAME	CODE	SIZE	DIMENSIONS	WEIGHT	RRP
 Camp Kitchen Pot Scrubber & Soap	ACK011071-120105	2 piece set	8 x 6.5 x 3cm	95g	
 Camp Kitchen Clean-Up Kit	ACK011071-122103	6 piece set	13 x 3 x 21cm (packed)	270g	
 Ultra-Sil Kitchen Sink	AUSSINK10	10L	ø37 x 11cm	42g	
	ASINK5	5L	ø22 x 15cm	98g	
 Kitchen Sink	ASINK10	10L	ø30 x 13cm	127g	
	ASINK20	20L	ø40 x 20cm	188g	
 Ultra-Sil Folding Bucket	AUSFB10	10L	ø20 x 25cm	23g	
	AFB10	10L	ø22 x 26cm	80g	
 Folding Bucket	AFB20	20L	ø27 x 34cm	110g	
 Trash Dry Sack	ATRASHDS	10L	44 x 34 x 5cm	100g	

# DINNERWARE

We know meals are an important part of your journey. That's why our dinnerware is specifically designed for use on adventures: Rugged yet light, ergonomic to use without any unnecessary bulk.





# EXPLORE THE RANGE

## CUTLERY + UTENSILS



ALPHA CUTLERY



DELTA CUTLERY



CAMP CUTLERY



TITANIUM CUTLERY

## DINNERWARE



DELTA SERIES DINNERWARE



DELTALITE SERIES DINNERWARE



X-SERIES COLLAPSIBLE DINNERWARE



X-SEAL & GO COLLAPSIBLE CONTAINERS



# ALPHALIGHT CUTLERY

Ultra-lightweight and durable, hard anodised aluminium cutlery.

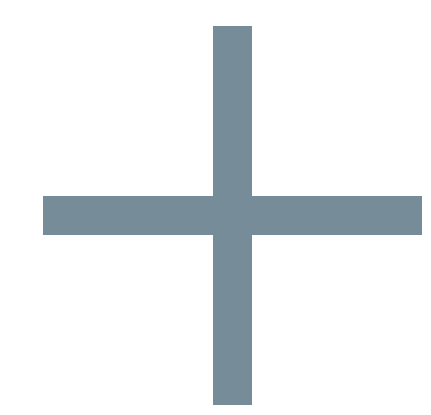

## OUR ALPHALIGHT CUTLERY FEATURES:

### TOUGH AND LIGHTWEIGHT

Hard-anodised aluminium utensils.

### SMOOTH FINISH

Smooth matte finish for a comfortable feel.

### HANDY

Comes with a mini carabiner to keep pieces together.

**BPA FREE**



## ALPHALIGHT CUTLERY



## ALPHASET CUTLERY 3PC SET

Light and strong hard-anodised aluminium 3-pc cutlery set with built-in hex tools.





# DELTA CUTLERY

Hard-wearing, functional and mouth-friendly camp cutlery.

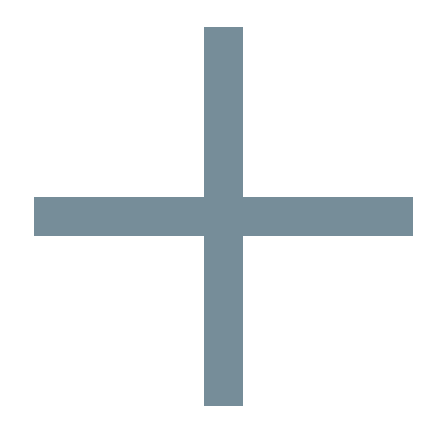

## OUR DELTA CUTLERY FEATURES:

### CLEVER AND PRACTICAL

Multi-functional ergonomic design, with knife, fork and spoon set designed to fit inside the Delta Bowl.

### STRONG AND DURABLE

Food-grade glass-reinforced polypropylene.

### EASY CLEAN

Odour and stain resistant.

### DISHWASHER SAFE

**BPA FREE**



## DELTA CUTLERY SET

### FEATURES

- Included carabiner securely clips pieces together and doubles as a hang tool
- Sharp, part-serrated, part-flat knife

COLOURS



## DELTA SPORK WITH SERRATED KNIFE

### FEATURES

- Serrated spreader knife integrated in handle

COLOURS



## DELTA LONG HANDLED SPOON

### FEATURES

- Longer reach for deeper containers
- Large capacity spoon-equal to 10ml/0.33fl oz (one dessert spoon)

COLOURS



# CAMP CUTLERY

Lightweight, all purpose  
BPA-free Camp Cutlery.

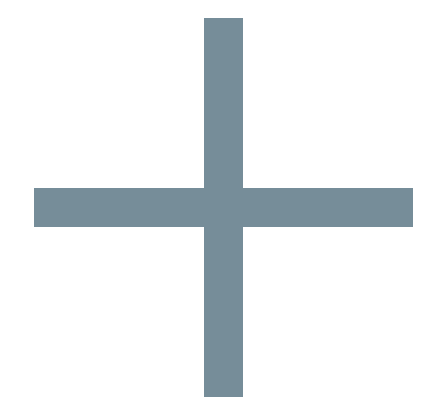

## OUR CAMP CUTLERY FEATURES:

### LIGHT, STRONG AND DURABLE

Made from BPA-free polypropylene glass composite.

### COMPACT PACKING

Shaped handles allow cutlery to neatly nest together for compact packing.

### FULL-SIZED DESIGN

Easy to use bare handed or gloved.

### EASY ORGANISATION

Small carabiner-compatible holes at each end.

### DISHWASHER SAFE

**BPA FREE**



CAMP CUTLERY



CAMP CUTLERY SET

Includes fork, knife and spoon clipped together with a custom aluminium carabiner for organised packing.







# TITANIUM CUTLERY

Exceptional strength to weight means your cutlery won't bend anymore than your back will carrying it.



## OUR TITANIUM CUTLERY FEATURES:

### TOUGH AND LIGHTWEIGHT

Made from 100% titanium.

### MOUTH FRIENDLY SHAPE

### ANODISED FINISH

### HANDY CARABINER

Comes with a mini carabiner to keep pieces together.

**BPA FREE**



TITANIUM SPORK



TITANIUM CUTLERY SET 3PC





### ALPHALIGHT CUTLERY





PRODUCT NAME	CODE	SIZE	WEIGHT	COLOUR	RRP
	ACUTALSPK	Spork	13g		
AlphaLight Cutlery	ACUTALSPKL	Long Spork	14g		
	ACUTALSPNL	Long Spoon			
AlphaLight Cutlery Set	ACUTALSET2	2 Piece	21g		
	ACUTALSET3	3 Piece	41g		
AlphaSet Cutlery Set	ACUTASET3	3 Piece	42g		

### DELTA CUTLERY

PRODUCT NAME	CODE	SIZE	WEIGHT	COLOUR	RRP
Delta Cutlery Set	ADCUTSET	3 Piece	29g		
Delta Spork with Serrated Knife	ADSPORK	Spork	12g		
Delta Long Handled Spoon	ADLSP00N	Long Spoon			



### CAMP CUTLERY

PRODUCT NAME	CODE	SIZE	WEIGHT	COLOUR	RRP
	ACUTKNIFE	Knife	9g		
	ACUTFORK	Fork	10g		
 Camp Cutlery	ACUTSPOON	Spoon	12g		
	ACUTSPORK	Spork	10g		
	ACUTTEA	Teaspoon	7g		
 Camp Cutlery Set	ACUTL	3 Piece	31g		

### TITANIUM CUTLERY

PRODUCT NAME	CODE	SIZE	WEIGHT	RRP
Titanium Spork	ACUTTSPK	Spork	17g	
 Titanium Cutlery Set	ACUTTSET3	3 Piece	40g	



# DELTA SERIES

Lightweight and durable with intuitive design details—there's a solution for all your camp dining needs.



## OUR DELTA RANGE FEATURES:

### PROTEX BASE

Protex hex pattern base reduces weight and disperses surface temperature.

### LIGHTWEIGHT

Lightweight, durable and easy-care.

### CLEVER DESIGN

Steep sides on our plates and bowls prevent food slopping over the sides, while the curvature of the base matches perfectly with the Delta Spoon and Spork.

### FOOD-GRADE

BPA-free, glass reinforced polypropylene is microwaveable and dishwasher safe.

### THUMB GRIP

Keeps your fingers out of your food and doubles as a carabiner hang loop.

**BPA FREE**



### DELTA PLATE

Keep your food on your plate and your fingers burn-free—a cleverly designed camp plate with guard rails and heat-dispersing base.



COLOURS 



### DELTA BOWL + DELTA BOWL WITH LID

A lightweight, hard-wearing and functional camp bowl with deep sides and a heat-dispersing base for burn-free fingers.

BOWL WITH LID

- Lid keeps food inside and doubles as a chopping board or plate

COLOURS 



### DELTA INSULMUG

Not your ordinary camp mug—this one's designed to not burn your fingers. The ergonomic cool-grip rim eliminates the need for a hard-to-pack handle.

INSULMUG

- ThermoSkin insulation sleeve for a comfortable grip
- Sipping lid with secure seal and hang loop

COLOURS 





# DELTA CAMP SET



## DELTA CAMP SET

The Delta Camp Set combines all the lightweight and easy-to-clean essentials from our Delta range: a plate, bowl, mug and the 3-piece cutlery set. They come packaged in a handy gusseted mesh pouch allowing wet dishes to air dry and secures with an easy-to-use drawstring closure.

SUITS ONE PERSON  
SET INCLUDES

Delta Plate, Delta Bowl,  
Delta Mug, Delta  
Cutlery Set

COLOURS





# DELTALIGHT SERIES

Super-lightweight, easy-care and BPA-free dinnerware designed to nest.

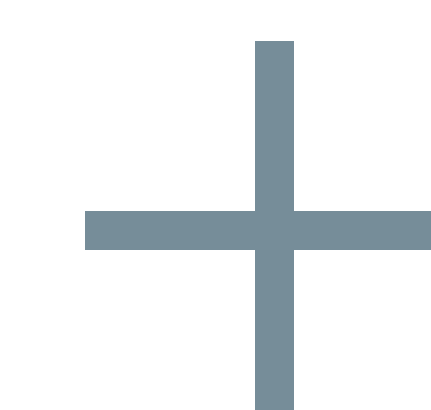

## OUR DELTALIGHT RANGE FEATURES:

### FOOD-GRADE

BPA-free, glass reinforced composite material is microwavable and dishwasher safe.

### CLEVER DESIGN

Steep sides on our plates and bowls prevent food slopping over the sides, while the curvature of the base matches perfectly with the Delta Spoon and Spork.

### ULTRALIGHT

Durable and easy-care.

### COMPACT PACKABILITY

DeltaLight Mugs and Bowls combine with AlphaPots and SigmaPots to create compact cooking and dining systems.



**BPA FREE**



## DELTALIGHT INSULMUG

With an easy-grip and generously-sized 350ml capacity, they come with removable silicone sipping lids and insulation sleeves.

### FEATURES

- Fluted ribbed walls for increased insulation when used with the sleeve and a comfortable grip when used without

COLOURS







# DELTALIGHT BOWL + CAMP SETS



## DELTALIGHT BOWL SET

SMALL SET INCLUDES

730ml bowl (charcoal)  
800ml bowl (pacific blue)

Nests inside 1.9L Alpha and Sigma Pots or outside 1.2L pots

LARGE SET INCLUDES

900ml bowl (charcoal)  
1000ml bowl (pacific blue)

Nests inside 2.7L Alpha and Sigma pots or outside 1.2L pots



## DELTALIGHT CAMP SET 2.2

SUITS TWO PEOPLE SET INCLUDES

2 InsulMugs, 2 Bowls, 2 Delta Cutlery Sets & Storage Pouch

Nests inside 2.7L Alpha and Sigma Pots or outside 1.2L pots



## DELTALIGHT SOLO SET

SUITS ONE PERSON SET INCLUDES

Mug, Bowl, Delta Cutlery Set & Storage Pouch

Nests inside 2.7L Alpha and Sigma Pots or outside 1.2L pots



## DELTALIGHT CAMP SET 4.4

SUITS FOUR PEOPLE SET INCLUDES

4 InsulMugs, 4 Bowls & Storage Pouch

Nests inside 2.7L Alpha and Sigma Pots or outside 1.2L pots





### DELTA SERIES

PRODUCT NAME	CODE	DIMENSIONS	WEIGHT	MATERIALS	COLOUR	RRP
Delta Plate	ADPLATE	25 x 22.3 x 3cm	118g	Glass-reinforced polypropylene		
Delta Bowl	ADBOWL	19 x 16 x 5cm	86g			
Delta Bowl With Lid	ADBOWLLID	19 x 16 x 6cm	149g			
Delta InsulMug	ADINMUG	ø10.5 x 9cm	125g			
Delta Camp Set	ADSET	28 x 25.2 x 11cm	300g			

### DELTALIGHT SERIES

PRODUCT NAME	CODE	SIZE	PACKED DIMENSIONS	WEIGHT	MATERIALS	COLOUR	RRP
DeltaLight InsulMug	ADLTINMUG		ø8.8 x 9.5cm	78g	Glass-reinforced polypropylene, neoprene sleeve		
DeltaLight Bowl Set	AKI2008-05042102	Small	ø15.3 x 5.5cm	96g	Glass-reinforced polypropylene		
	AKI2008-05062101	Large	ø17.4 x 5.5 cm	143g			
DeltaLight Solo Set	ADLTSOLOSET	1 Person	ø19 x 9.5cm	170g	Glass-reinforced polypropylene, Nylon sleeve		
DeltaLight Camp Set 2.2	ADLTSET2.2	2 Person		383g			
DeltaLight Camp Set 4.4	ADLTSET4	4 Person	ø19 x 11cm	650g			

# X-SERIES DINNERWARE

Made from flexible silicone, this collapsible dinnerware range packs away flat.

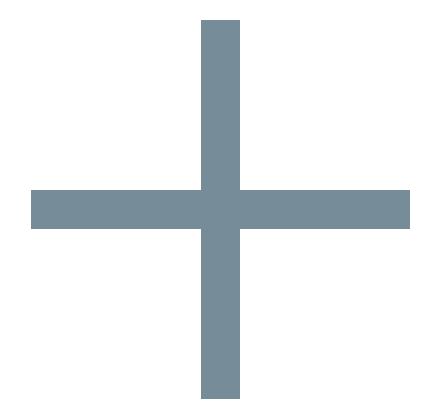

## OUR X-SERIES DINNERWARE FEATURES:

### FOOD GRADE

BPA-free, food grade flexible silicone sides.

### SUPER COMPACT

Each piece collapses to a fraction of its in-use size.

### EASE OF USE

Calibrated ridges act as a measuring cup.

FOOD GRADE  
HEAT RESISTANT  
SILICONE

BPA FREE





X-PLATE

X-MUG

XL-BOWL

X-CUP

X-BOWL

X-SHOT

**FOOD GRADE  
HEAT RESISTANT  
SILICONE**

**BPA FREE**

## X-SERIES DINNERWARE

### X-BOWLS + X-PLATE

- Cut resistant, stable base is great for chopping and cutting food

### X-CUP + X-MUG

- Nylon ring at the top maintains shape and prevents scalded fingertips

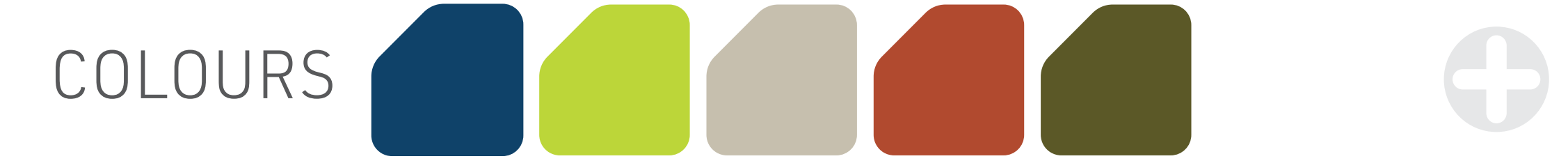



## COOL GRIP X-TUMBLER & X-MUG

Keep your fingers cool and your drink secure in your grasp. The innovative Cool Grip construction uses specially designed fins to keep your fingers protected from the heat of your drink—and the rigid rim keeps it sturdy and easy to drink out of.

### FEATURES

- Nests with other X-Series products

COLOURS  





# X-SETS

## X-SET 2-PIECE

Collapsible nesting bowl and mug set for a solo camper.

TWO PIECE SET INCLUDES

X-Mug, X-Bowl, & Storage Pouch



## X-SET 3-PIECE

Collapsible three-piece dinnerware set nests neatly in its own zippered pouch.

THREE PIECE SET INCLUDES

X-Mug, X-Bowl, X-Plate & Storage Pouch





# X-SEAL & GO

Perfect for any adventure on the road, on the trail, or at the office.

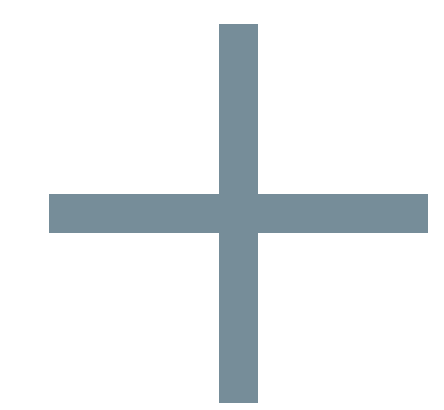

## OUR X-SEAL & GO RANGE FEATURES:

### QUICK CLOSE LIDS

Leakproof, sealable lid locks into place with a simple quarter turn.

### ERGONOMIC DESIGN

Cleverly designed lids and base have ergonomic grips for easy twisting.

### EASY CLEAN THREAD

Three individual threads make cleaning much easier.

### TINY PACK SIZE

Our 600ml/20oz X-Seal & Go collapses to 3/4in tall to save space in your bag.

### VOLUMETRIC MEASUREMENTS

Moulded on the inside of each container.

### CONVENIENT

Microwave and dishwasher safe.

FOOD GRADE  
HEAT RESISTANT  
SILICONE

BPA FREE



Small and Medium sizes fit inside Large and XLarge lids to create handy lunch kits

## X-SEAL & GO



SMALL



MEDIUM



LARGE



XLARGE

## X-SEAL & GO SETS



SET SMALL

1 Large / 1 Small



SET LARGE

1 XL / 1 Medium



## X-SERIES

PRODUCT NAME	CODE	DIMENSIONS	COLLAPSES TO	WEIGHT	MATERIALS	COLOUR	RRP
X-Shot	AXSHOT	ø6.5 x 6cm	1.2cm	24g	Food grade flexible silicone		
X-Cup	AXCUP	ø9.5 x 9.5cm		45g			
X-Mug	AXMUG	ø11 x 8cm		60gz			
X-Bowl	AXBOWL	ø15 x 6cm	1.5cm	80g	Food grade flexible silicone, Nylon 66		
XL-Bowl	AXLBOWL	ø15 x 5.5cm		110g			
X-Plate	AXPLATE	ø20 x 3.5cm		164g			
X-Mug Cool Grip	AXCGMUG	ø11 x 8cm	1.5cm	72g	Food grade flexible silicone, Nylon 66		
X-Tumbler Cool Grip	AXCGTUM	ø10.3 x 7.5cm		68g			

## X-SETS

PRODUCT NAME	CODE	COLLAPSES TO	WEIGHT	MATERIALS	COLOUR	RRP
X-Set: 2-Pce	AXSET2	1.5cm	180g	Food grade flexible silicone, Nylon 66		
X-Set: 3-Pce	AXSET3		364g			

## X-SEAL & GO

PRODUCT NAME	CODE	SIZE	DIMENSIONS	COLLAPSES TO	WEIGHT	MATERIALS	COLOUR	RRP
X-Seal & Go	AXSEALS	Small	ø9 x 7cm	2cm	60g	Food grade flexible silicone, Nylon 66 base, polypropylene lid		
	AXSEALM	Medium	ø11.4 x 8.5cm		90g			
	AXSEALL	Large	ø15.5 x 5cm	3cm	145g			
	AXSEALXL	XL	ø18.5 x 6cm		195g			
X-Seal & Go Set	AXSEALSETS	Small		3.5cm	205g			
	AXSEALSETL	Large			285g			



# COOKWARE

Modular systems designed for ergonomic and efficient cooking when in use—and space-saving when packed away.





# EXPLORE THE RANGE

## COOKING TOOLS + UTENSILS



CAMP KITCHEN  
FOLDING SERVING SPOON  
+ SPATULA



CAMP KITCHEN  
TOOL KIT

## COOKWARE + COOKWARE SETS



ALPHA SERIES



X-POT



ALPHA SETS



X-SETS



# FOLDING COOKING UTENSILS

Designed with the camp cook in mind, an ergonomic handle and strong, lightweight materials all add to the cooking experience.

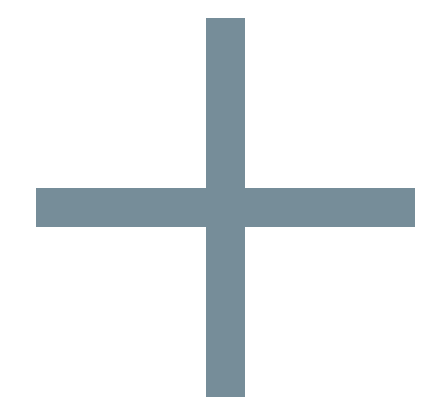

## OUR FOLDING COOKING UTENSILS FEATURE:

### STRONG AND LIGHTWEIGHT

Made with glass reinforced Nylon and food grade silicone.

### LIGHTWEIGHT

Perfect for fast-and-light backpacking trips.

### FLEX AND STRENGTH

Glass reinforced Nylon gives enough flex to flip pancakes and enough rigidity to scrape off burnt rice.

### ERGONOMIC DESIGN

Sturdy and easy to hold with a shape that's designed to scrape clean the sides of our cookware.

### PACKS UP SMALL

Simply fold the handle when the camp cooking is done—easily stows inside the 1.2L Alpha and Sigma Pots.

**BPA FREE**



## CAMP KITCHEN FOLDING SPATULA

This ultralight folding spatula flips pancakes as easily as it packs away.



## CAMP KITCHEN FOLDING SERVING SPOON

Prepare and cook delicious meals in the backcountry with this ultralight folding serving spoon.

### FEATURES

- 100ml volume and volumetric measurements for measuring ingredients





## CAMP KITCHEN TOOL KIT

This 10-piece cooking and wash kit is made for your backcountry camp kitchen.



10 PIECE KIT  
INCLUDES

- Folding Spatula
- Folding Serving Spoon
- Pot Scrubber
- 50ml Wilderness Wash
- 2x 50ml + 1x 100ml Reusable Spice/Oil Bottles
- Double Sided Washcloth
- DryLite Dish Towel
- Hangable Nylon Storage Roll





## COOKING TOOLS + UTENSILS

PRODUCT NAME	CODE	DIMENSIONS	PACKED DIMENSIONS	WEIGHT	MATERIALS	RRP
 Camp Kitchen Folding Spatula	ACK022021-040101	23.5 x 7.5 x 2cm	12 x 7.5 x 2cm	57g	Glass-reinforced Nylon	
Camp Kitchen Folding Serving Spoon	ACK022031-040102	23 x 6.5 x 4.5cm	12 x 6.5 x 2cm	66g	Glass-reinforced Nylon, Silicone	
 Camp Kitchen Tool Kit 10pc	ACK022011-122104		12 x 23.5 x 6cm	310g	Spatula: Glass-reinforced Nylon, Serving Spoon: Glass-reinforced Nylon; Silicone; Scrubber: Polypropylene + Nylon bristles; Wilderness Wash; Spice Bottles: HDPE; Towels: 80% Polyester-20% Nylon, Pouch: Nylon	



# ALPHA SERIES

Bringing performance and style to outdoor cookware, this versatile range of lightweight nesting pots and pans caters to a wide variety of users from extreme expeditioners and outdoor adventurers to family campers.

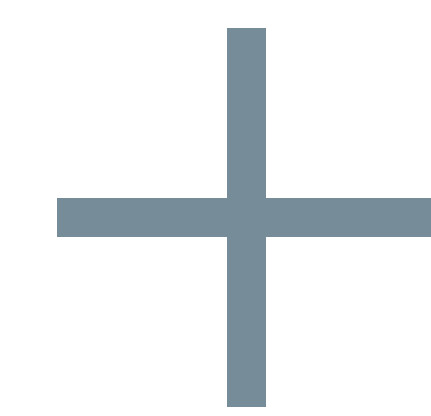

## OUR ALPHA SERIES POTS FEATURE:

### FULLY FEATURED LID

Easy flow strainer lid for efficient draining with integrated patent-pending LID KEEP to perch the lid out of dirt's reach.

### LIGHT AND SPACE-SAVING

A two pot, two-person cook set weighs just 765g and nests to ø19 x 13cm.

### PIVOT-LOCK

PIVOT-LOCK handle with ergonomic silicone grip for secure, easy operation.

### SMART COOKING

Graded volumetric scale for accurate measurement.

### EASY CLEAN

Large internal radius allows easy cleaning and matches the Delta cutlery profile.

### NESTING DESIGN

AlphaPots are compatible with DeltaLight dinnerware, SigmaPots and AlphaPans.

### FOOD SAFE SETS

DeltaLight dinnerware used in our Alpha Sets is microwave and dishwasher safe, and made from BPA-free, food-grade materials.



**BPA FREE**



**HARD ANODISED ALUMINIUM**



## ALPHAPAN

Flaunt your culinary flair and saute, scramble or stir-fry in the backcountry with our AlphaPans. The advanced PFOA-free coating provides non-stick performance with a durable and abrasion resistant finish.

### FEATURES

- Ergonomic flip-up handle with safety lock folds underneath the pan when not in use for compact stacking and storage
- 8in AlphaPan fits perfectly around the base of the 2.7L Alpha or Sigma Pots

SIZES 8IN / 10IN



## ALPHAPOT

High quality aluminium and anodising keep weight down, while the nesting design and locking handle keeps your gear neat and organised.

SIZES 1.2L / 1.9L / 2.7L / 3.7L





# ALPHA SETS



## ALPHASET 1.1

SUITS ONE PERSON  
SET INCLUDES

- 1x AlphaPot 1.2L
- 1x DeltaLight InsulMug
- 1x DeltaLight Bowl



## ALPHASET 2.2

SUITS TWO PEOPLE  
SET INCLUDES

- 1x AlphaPot 1.2L
- 1x AlphaPot 2.7L
- 2x DeltaLight InsulMugs
- 2x DeltaLight Bowls
- 1x Dishcloth



## ALPHASET 2.1

SUITS TWO PEOPLE  
SET INCLUDES

- 1x AlphaPot 1.9L
- 2x DeltaLight InsulMugs
- 2x DeltaLight Bowls



## ALPHASET 4.2

SUITS FOUR PEOPLE  
SET INCLUDES

- 1x AlphaPot 2.7L
- 1x AlphaPot 3.7L
- 4x DeltaLight InsulMugs
- 4x DeltaLight Bowls
- 1x Dishcloth







## ALPHAPOTS & PANS

PRODUCT NAME	CODE	SIZE	COLLAPSED DIMENSIONS	WEIGHT	MATERIALS	RRP
 AlphaPot	AKI3004-02380501	1.2L	ø16 x 10cm	187g	Hard-anodised aluminium alloy, stainless silicone grip handle, aluminium lid	
	AKI3004-02390502	1.9L	ø17 x 12cm	230g		
	AKI3004-02400503	2.7L	ø19 x 13cm	282g		
	AKI3004-02410504	3.7L	ø21 x 15cm	337g		
 AlphaPan	APOTAPAN8	8in	ø20 x 5cm	245g	Hard-anodised aluminium alloy, stainless steel silicone grip handle	
	APOTAPAN10	10in	ø26 x 5cm	335g		

## ALPHA SETS

PRODUCT NAME	CODE	COLLAPSED DIMENSIONS	WEIGHT	MATERIALS	RRP
AlphaSet 1.1	AKI5004-03122101	ø16 x 10cm	330g		
	AlphaSet 2.1	AKI5004-03122103	ø17 x 12cm	521g	Hard-anodised aluminium alloy, stainless steel handle, aluminium lid, glass-reinforced polypropylene dinnerware, neoprene mug sleeve
	AlphaSet 2.2	AKI5004-03122104	ø19 x 13cm	765g	
AlphaSet 4.2	AKI5004-03122105	ø21 x 15cm	1221g		



# X-POT

Collapsible pots for quick and easy backcountry cooking. Backpacker Magazine's Editors' Choice award was bestowed upon the X-Pot in 2015 for its innovation, space-saving capability and functionality.

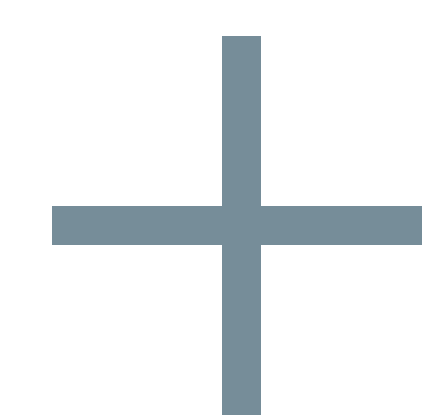

## OUR X-POTS FEATURE:

### SUPER COMPACT

Each piece collapses to a fraction of its in-use size.

### GREATER CONTROL

Translucent, durable plastic lid shortens boil time and allows finer temperature control.

### NESTING DESIGN

X-Series products collapse and nest inside each other to form compact cooking and dining sets.

### LIGHTWEIGHT AND DURABLE

Hard-anodised aluminium base provides uniform heat distribution.

### SMART COOKING

Measurements imprinted on the inside.

### EASY TRANSPORT

Silicone handles secure the lid to the pot for transport.



**BPA FREE**

**HARD ANODISED ALUMINIUM**

**FOOD GRADE HEAT RESISTANT SILICONE**





### X-POT

Our X-Pots are the perfect solution for consumers who are light on storage space but who still want to cook real food in the backcountry.

SIZES 1.4L / 2.8L / 4.0L

COLOURS



### X-PAN 8 INCH

This 8-inch pan offers a low profile, space-saving design that fits neatly together with the 2.8L X-Pot in a nesting pot/pan system.

#### FEATURES

- Stiff and non-corrosive stainless steel handles fold up for use and down for transport

COLOURS





## X-POT KETTLE

Is it a pot or is it a kettle? It's both—and now available in two sizes. The perfect all-in-one flat-pack solution for fast and light adventures.

### FEATURES

- A silicone strap secures the lid and handles during transport

SIZES 1.3L / 2.0L

COLOURS   



 VIDEO



## X-BREW COFFEE DRIPPER

For the environmentally minded backcountry barista: a collapsible coffee dripper with super-fine stainless steel filter—no need for single-use paper filters!

### FEATURES

- Makes up to two cups—just add coffee grounds and hot water

COLOURS 



 VIDEO





# X-SETS



## X-SET 11

SUITS TWO PEOPLE  
SET INCLUDES

- 2x X-Mugs
- X-Pot Kettle 1.3L



## X-SET 31

SUITS TWO PEOPLE  
SET INCLUDES

- 2x X-Mugs
- 2x X-Bowls
- X-Pot 2.8L



## X-SET 12

SUITS TWO PEOPLE  
SET INCLUDES

- 2x X-Mugs
- 2x X-Bowls
- X-Pot Kettle 2.0L



## X-SET 32

SUITS TWO+ PEOPLE  
SET INCLUDES

- X-Pot Kettle 1.3L
- X-Pan 8 Inch
- X-Pot 2.8L



## X-SET 21

SUITS ONE PERSON  
SET INCLUDES

- 1x X-Mug
- 1x X-Bowl
- X-Pot 1.4L





## X-SERIES COOKWARE

PRODUCT NAME	CODE	SIZE	DIMENSIONS	COLLAPSED DIMENSIONS	WEIGHT	MATERIALS	COLOUR	RRP
X-Pot	AXPOT1.4	1.4L	ø19 x 6.4cm	4cm	250g	Hard-anodised aluminium base, food-grade silicone side walls, Tritan strainer lid		
	AXPOT2.8	2.8L	ø21.3 x 11.5cm		365g			
	AXPOT4.0	4.0L	ø25.4 x 9.8cm	4.5cm	562g			
X-Pan 8 Inch	AXPAN8INCH		ø18 x 4cm		230g	Hard-anodised aluminium, silicone handles		
X-Pot Kettle	AXKET1.3	1.3L	ø15.3 x 9cm	3.5cm	186g	Hard-anodised aluminium base, food-grade silicone side walls, Tritan strainer lid		
	AXKET2.2	2.0L	ø19.5 x 11cm	4.5cm	290g			
X-Brew Coffee Dripper	AXBREW		ø11 x 9cm	2cm	85g	Food-grade silicone, stainless steel mesh		

## X-SETS

PRODUCT NAME	CODE	COLLAPSED DIMENSIONS	WEIGHT	MATERIALS	COLOUR	RRP
X-Set 11	AXSET11	4cm	316g	Hard-anodised aluminium, food-grade silicone side walls, Tritan lid, Nylon 66 rims / kettle handles		
X-Set 12	AXSET12	4.5cm	584g			
X-Set 21	AXSET21		394g			
X-Set 31	AXSET31	5cm	607g			
X-Set 32	AXSET32		779g			

# WATER TRANSPORT

Our home in Western Australia is one of the driest places in the world—when we plan our adventures, water transport is top of our list.

Designed to work well in the harshest environments, our water transport solutions are lightweight, collapsible, easy to operate and reliable.





# EXPLORE THE RANGE

## WATERCELLS



WATERCELL X



WATERCELL ST

## PACK TAPS



PACK TAP





Multi-function cap



Shower attachment



Fill handle



Adjustable webbing strap system



## WATERCELL X

Ditch the awkward jerry-can or plastic water container and embrace the Watercell X, your durable soft-sided water storage solution for any adventure.

We've provided multiple lash, carry and hang options, a cap that lets you fine-tune flow-control and a baffled design that makes for easy packing when full.

The wide-mouth opening is easy to fill and uses a standard thread to make it compatible with most common water filtration systems. And when not in use it folds away to a minimal size that barely takes up any room in your pack, kayak or vehicle.

### FEATURES

- Strong RF-welded 3D shape with internal baffle for ease of use and compact packing

SIZES 4L / 6L / 10L / 20L



tpü BPA FREE NON PFC





## WATERCELL ST

Minimalist, strong and pliable, your streamlined water storage solution for lightweight adventures.

### FEATURES

- Strong RF-welded 3D shape with internal baffle for ease of use and compact packing
- Screw-top standard wide-mouth opening

SIZES 4L / 6L / 10L



tpü

BPA FREE

NON PFC



## PACK TAP

Bulk water on tap—ideal for groups, sea kayaking or whenever you have to carry a lot of water.

### FEATURES

- Double layer, tough Mylar bladder
- Easy one-handed valve operation
- Bladder can be easily and cheaply replaced to maximise life span of product

SIZES 4L / 6L / 10L

COLOURS





## WATERCELLS

PRODUCT NAME	CODE	SIZE	DIMENSIONS	WEIGHT	MATERIALS	COLOUR	RRP
Watercell X	AWATCELX4	4L	28 x 21.5 x 10cm	172g	400D Nylon, TPU lining and cap		
	AWATCELX6	6L	35 x 23 x 10.5cm	196g			
	AWATCELX10	10L	42 x 28.5 x 12.5cm	245g			
	AWATCELX20	20L	51.5 x 37.5 x 16cm	336g			
Watercell ST	AWATCELST4	4L	28 x 21.5 x 10cm	126g	TPU		
	AWATCELST6	6L	35 x 23 x 10.5cm	148g			
	AWATCELST10	10L	42 x 28.5 x 12.5cm	188g			

## PACK TAPS

PRODUCT NAME	CODE	SIZE	DIMENSIONS	WEIGHT	MATERIALS	COLOUR	RRP
Pack Tap	APT4LT	4L	34 x 32cm	114g	300D polyester exterior, Mylar bladder		
	APT6LT	6L	36 x 38cm	124g			
	APT10LT	10L	41 x 43cm	192g			
Pack Tap Replacement Bladder	ABLA	4/6L			Mylar		
	ABLA10	10L					



# TRAVEL + COMMUTE



# TRAVEL + COMMUTE

TRAVEL BROADENS THE MIND.  
SMART TRAVEL DOES IT IN NICE,  
SLIM BAGS.

## MODULAR PACKING

Once you've used our garment mesh bags, packing cells or toiletry bags, you'll never look back. And you'll certainly never waste a moment of precious vacation time rummaging in a bag, or mopping up personal care product spills.

## PRODUCTS FOR 24/7 USE ACROSS SEVEN CONTINENTS

The perfect balance of weight, durability and packability, our Everyday Carry products are incredibly light and unbelievably useful.



EVERY DAY CARRY

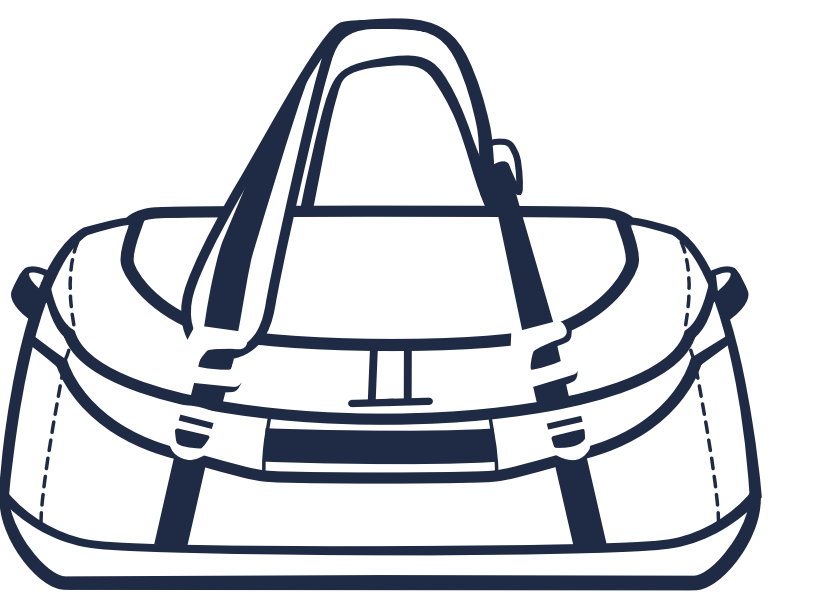

BAGS + LUGGAGE

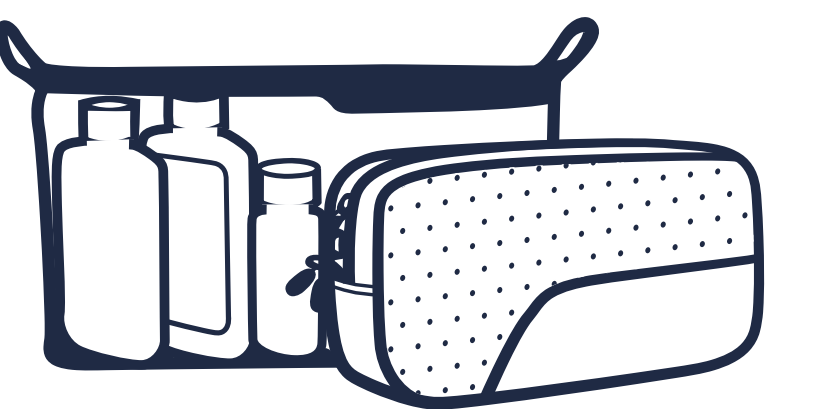

ORGANISATION

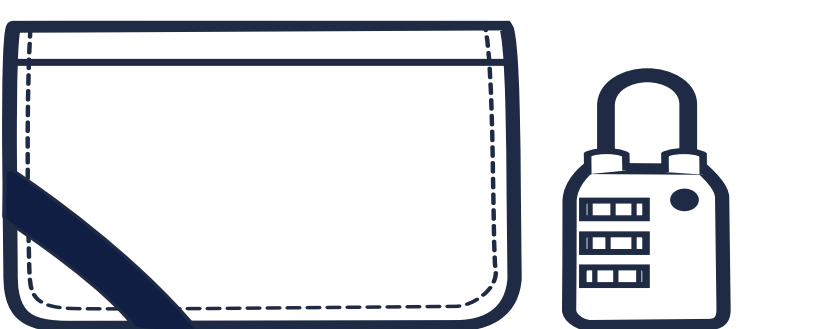

TRAVEL ACCESSORIES





# EVERY DAY CARRY

Small enough to easily fit in a short pocket, the beauty of the items in this range is their simplicity. Attention to detail and quality materials make these products as tough and versatile as they are packable.

Bike rides, impromptu thru-hikes shopping excursions, packing essentials for a day hike; wherever you go, these tiny packs and bags go with you.



# EXPLORE THE RANGE

PACKABLE BAGS			UMBRELLAS
<p>UPDATED</p>  <p>ULTRA-SIL SHOPPING BAG</p>	<p>UPDATED</p>  <p>ULTRA-SIL DAY PACK</p>	<p>UPDATED</p>  <p>ULTRA-SIL DRY DAY PACK</p>	 <p>ULTRA-SIL TREKKING UMBRELLA</p>  <p>POCKET UMBRELLA</p>



# PACKABLE BAGS

## The bag to take when you're not taking a bag...

We know lightweight better than anyone, and we've stripped our packable bags down to the bare minimum, all without compromising on strength and performance.



### OUR PACKABLE BAGS FEATURE:

#### SMALL

Exceptionally compact packable design.

#### EASY TO USE

Siliconised Nylon fabric for easy packing and water resistance.

#### STRONG AND DURABLE

Bar-tacked and reinforced stitching at key stress points.

#### SUPER COMPACT

Packs into an attached Ultra-Sil stuff sack.





## FOLD FLAT POCKET SHOPPING BAG

Our Fold Flat Pocket Shopping Bag is light, strong and packable. Made with lightweight material with a simple foldable design, it's easy to always have on hand for quick stops to convenient stores, gyms and lunch bars.

### FEATURES

- Light and strong 70D Nylon packs up small
- Small handles for easy carrying

SIZE 9L

COLOURS 



**70D** WATERPROOF FABRIC



Packs down flat with its easy-to-fold design



Security snap at opening keeps contents in place



**UPDATED**

**ULTRA-SIL SHOPPING BAG**

Our reusable Ultra-Sil Shopping Bag can comfortably carry 12 bottles of wine.

COLOURS



**30D ULTRA-SIL** **NON PFC**

**SUSTAINABLE DESIGN**  
 • CO Non-PFC Water Repellent Finish  
 • bluesign® APPROVED main body fabric





# LIGHTWEIGHT PACKABLE BAGS



**UPDATED**

## ULTRA-SIL DAY PACK

Our award-winning Ultra-Sil Day Pack is a minimalist must-have that provides surprising versatility and performance for such a small package.

With a handy 20 litre capacity, it is equally at home as a summit pack on hiking adventures, as a sightseeing day pack while travelling, or for carrying an impromptu grocery shop while on foot or two wheels.

COLOURS



**30D ULTRA-SIL** **NON PFC**

**SUSTAINABLE DESIGN**  
 • CO Non-PFC Water Repellent Finish  
 • bluesign® APPROVED main body fabric

**UPDATED**

## ULTRA-SIL DRY DAY PACK

An ultralight daypack that is waterproof and that stows away in its own tiny stuff sack.

FEATURES

- 22 litre capacity
- Elasticised compression lacing system

COLOURS



**30D ULTRA-SIL** **NON PFC**

**SUSTAINABLE DESIGN**  
 • CO Non-PFC Water Repellent Finish  
 • bluesign® APPROVED main body fabric



# UMBRELLAS



## ULTRA-SIL TREKKING UMBRELLA

Keep dry and shaded on the trail with this compact and lightweight umbrella.

### FEATURES

- Large canopy size of 96cm
- UPF 50+ sun protection

### COLOURS

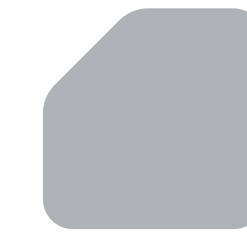

**30 D ULTRA-SIL**



## POCKET UMBRELLA

Be prepared and keep dry with this lightweight and compact mini umbrella.

### FEATURES

- Canopy diameter 83cm

### COLOURS





### LIGHTWEIGHT PACKABLE BAGS

PRODUCT NAME	CODE	VOLUME	WEIGHT	COLOUR	RRP
Fold Flat Pocket Shopping Bag	ATC012081-05	9L	34g		
Ultra-Sil Day Pack	ATC012021-06	20L	72g		
Ultra-Sil Dry Day Pack	ATC012051-07	22L	110g		
Ultra-Sil Shopping Bag	ATC012011-07	25L	46g		

### UMBRELLAS

PRODUCT NAME	CODE	DIMENSIONS	COLLAPSED DIMENSIONS	WEIGHT	MATERIALS	COLOUR	RRP
Ultra-Sil Trekking Umbrella	AUMBBK	ø98 x 58cm	ø5.7 x 24cm	280g	CORDURA® Nylon canopy with a water-shedding DWR		
TravellingLight Pocket Umbrella	AUMBMINI	ø84 x 52cm	ø4 x 18.5cm	150g			

# BAGS + LUGGAGE





## DUFFLE BAG

The Sea to Summit Duffel is a fully featured expedition duffel for hauling gear. It was designed to be more versatile, easier to use and more comfortable to carry than any other duffel at base camp.

### FEATURES



- Large lid for easy packing and fast access to gear
- Multi-functional handles provide three versatile carry options
- Dual-zipper is super durable and anti-theft
- High strength hooks allow quick change of handle position

SIZES 45L / 65L / 90L / 130L

COLOURS  



## DUFFLE BAGS

PRODUCT NAME	CODE	SIZE	DIMENSIONS	WEIGHT	MATERIALS	COLOUR	RRP
	ADUF45	45L	58 x 29 x 29cm	1650g			
 Duffel Bag	ADUF65	65L	66 x 33 x 33cm	1750g	Waterproof tarpaulin laminate, 1000D Nylon base, YKK double #10 zipper		
	ADUF90	90L	74 x 37 x 37cm	2050g			



# ORGANISATION



# EXPLORE THE RANGE

## PACKING ORGANISATION

UPDATED



ULTRA-SIL GARMENT MESH BAG

## TOILETRY CASES

UPDATED



HANGING TOILETRY BAG



CLEAR ZIPTOP POUCH



# PACKING SOLUTIONS

Whether your idea of travel is by plane, boat or car our range of travel accessories will help you organise and separate your clothes, shoes, toiletries and documents without taking up precious luggage space or adding weight.



## OUR PACKING ORGANISATION RANGE FEATURES:

### ULTRA-SIL FABRIC

Great for travel as it's water resistant.

### DURABLE ZIPS

with strong grab tags for easy, secure opening and closing.

### INTERNAL POCKETS

### 3D SHAPES

Fit the contours of modern luggage.

**30 D ULTRA-SIL**



**UPDATED**

## ULTRA-SIL GARMENT MESH BAG

Organise your garments, organise your travelling life.

### FEATURES

- Ultra-lightweight, packs flat when empty

SIZES S / M / L

COLOURS





# TOILETRY CASES

Ultra-lightweight and water resistant  
Ultra-Sil fabric keeps toiletry spills  
contained while internal zippered mesh  
pockets ensure that you stay organised—  
all without adding bulk.

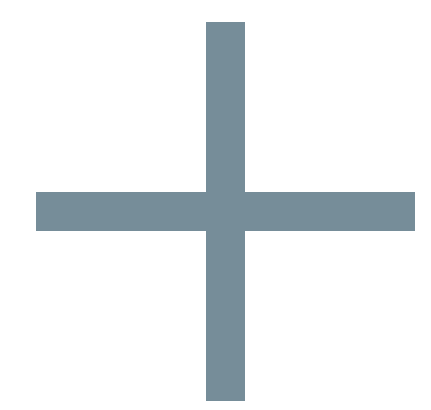

## OUR TOILETRY CASE RANGE FEATURES:

### ULTRA-SIL

Great for travel as it's water resistant.

### DURABLE ZIPS

with strong grab tags for easy,  
secure opening and closing.

### INTERNAL POCKETS

and dividers for organisation.

### 3D SHAPES

Fit the contours of modern luggage.

**30D** ULTRA-SIL



**UPDATED**

## ULTRA-SIL HANGING TOILETRY BAG

Hangs in your bathroom, on a  
tree branch or off your wing mirror  
for ease of access.

### FEATURES

- Shatterproof detachable mirror included

SIZES S / L

COLOURS   





### TPU CLEAR ZIPTOP POUCH KIT

TSA-friendly clear zip top pouch with leak-proof reusable bottles.

FEATURES

- Welded construction with leak-resistant zipper
- Includes 3 x 100mL and 3 x 50mL Sea to Summit leak-proof bottles

COLOURS





### PACKING ORGANISATION

PRODUCT NAME	CODE	SIZE	DIMENSIONS	WEIGHT	MATERIALS	COLOUR	RRP
Ultra-Sil Garment Mesh Bag Small	ATC022031-04	Small	25 x 19 x 9cm	60g	30D Siliconised CORDURA®, mesh		
	ATC022031-05	Medium	35 x 25 x 9cm	86g			
	ATC022031-06	Large	40 x 30 x 9cm	110g			

### TOILETRY CASES

PRODUCT NAME	CODE	SIZE	DIMENSIONS	WEIGHT	MATERIALS	COLOUR	RRP
Ultra-Sil Hanging Toiletry Bag	ATC023011-04	Small	40 x 23 x 6cm	80g	30D Ultra-Sil		
	ATC023011-06	Large	52 x 25 x 8cm	114g			
TPU Clear Ziptop Pouch Kit	ATLTPUCZTP		20 x 11 x 4.5cm	110g	TPU film, water-resistant zipper, PE bottles		

# EXPLORE THE RANGE

## TRAVEL SECURITY

UPDATED



RFID TRAVEL WALLETS

## TRAVEL COMFORT

UPDATED



EYE SHADES



## TRAVEL COMFORT



**UPDATED**

### EYE SHADE

Our TravellingLight EyeShade is ideal for airplane travel, daytime napping or when you're lucky enough to experience the midnight sun.

#### FEATURES

- Delicate, contoured microfibre lining for sleeping comfort
- Nose baffle and easy to adjust strap ensure a perfect fit and light-free sleep
- Washable and reusable
- Set of ear plugs included







## NECK POUCH RFID

Keep your valuables close and your credit cards safe from digital skimmers with RFID-protection.

### FEATURES

- Adjustable and comfortable webbing neck strap
- Small: compact passport size featuring two pockets



## NECK WALLET RFID

RFID proof neck wallet for organisation and security.

### FEATURES

- Five pockets
- Soft, comfortable webbing neck strap





## TRAVEL WALLET RFID

A lightweight, RFID-proof way to keep your travel life sorted.

### FEATURES

- Small: Four credit card slots and two separated bank note sleeves
- Medium: Seven credit card slots, two sleeves, pen holder, zippered coin pouch and an external pocket for boarding pass or itinerary—also fits a passport
- Large: Eight credit card slots, two large sleeves, pen holder, zippered coin pouch and an external pocket for boarding passes.

SIZES S / M / L

COLOURS

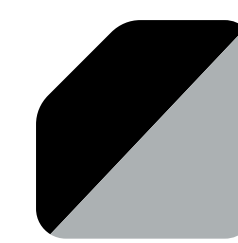

## CARD HOLDER RFID

Slim-profile card holder for protecting your information from digital skimmers.

### FEATURES

- Four internal card sleeves





## TRAVEL SECURITY - RFID

PRODUCT NAME	CODE	SIZE	DIMENSIONS	WEIGHT	MATERIALS	COLOUR	RRP
	ATC033061-04	Small	11 x 9 x 2cm	56g			
Ultra-Sil Wallet RFID	ATC033061-05	Medium	17.5 x 10.5 x 2cm	93g	30D siliconised CORDURA®, copper-nickel film		
	ATC033061-06	Large	23 x 11 x 2cm	112g			
Ultra-Sil Card Holder RFID	ATC033061-13		9.5 x 7 x 0.5cm	14g	210D Nylon, copper-nickel film		
Ultra-Sil Neck Pouch RFID	ATC033071-04	Small	14.5 x 12.5 x 3cm	20g	30D siliconised CORDURA®, soft 3D mesh, copper-nickel film		
Ultra-Sil Neck Wallet RFID	ATC033071-05		21 x 13.5 x 1.5cm	40g	30D siliconised CORDURA®, soft 3D mesh, copper-nickel film		

## TRAVEL COMFORT

PRODUCT NAME	CODE	DIMENSIONS	WEIGHT	MATERIALS	COLOUR	RRP
Ultra-Sil Eye Shade	ATC032011-05	19.5 x 8cm	23g	Contoured microfibre lining		

# CARE + PROTECTION





# CARE + PROTECTION

## SMALL THINGS THAT MAKE A BIG DIFFERENCE

### TOWELS

Absorbent, packable and fast drying, our towels are available in a range of sizes making them perfect for all adventures.

### PERSONAL CARE

Whether it's cleaning wipes, liquid soaps, sanitisers, pocket laundry wash, shampoo, body wash or insect protection, we have you, quite literally, covered!

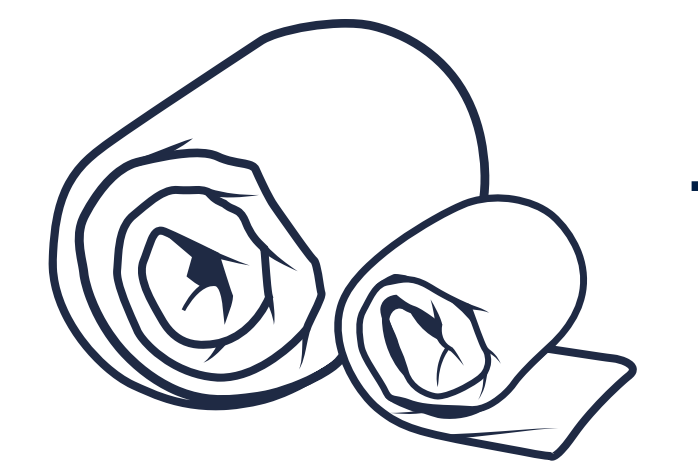

TOWELS



PERSONAL CARE

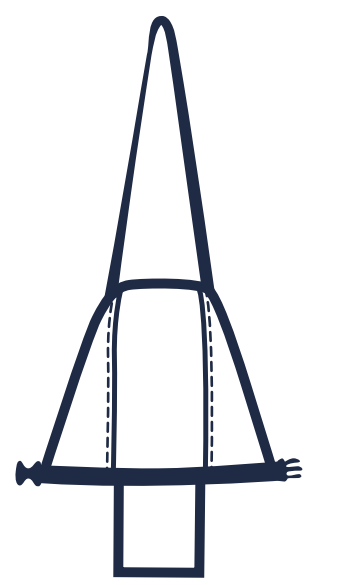

UTILITY + CONVENIENCE

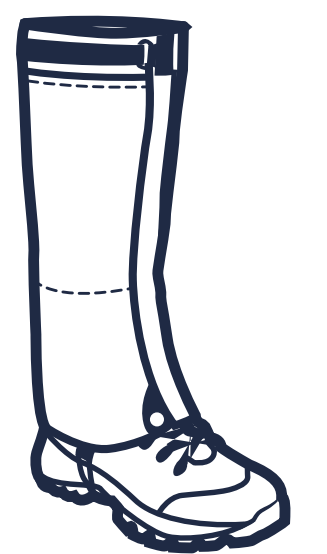

GAITERS

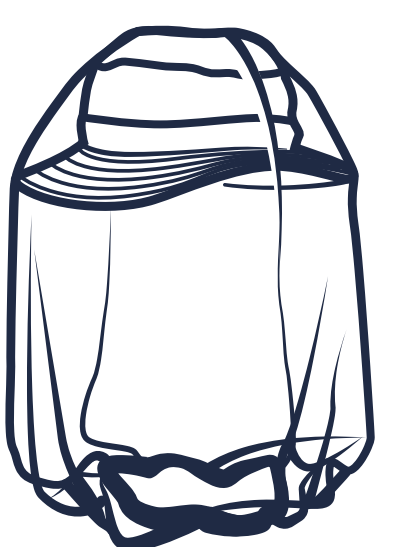

INSECT PROTECTION CLOTHING

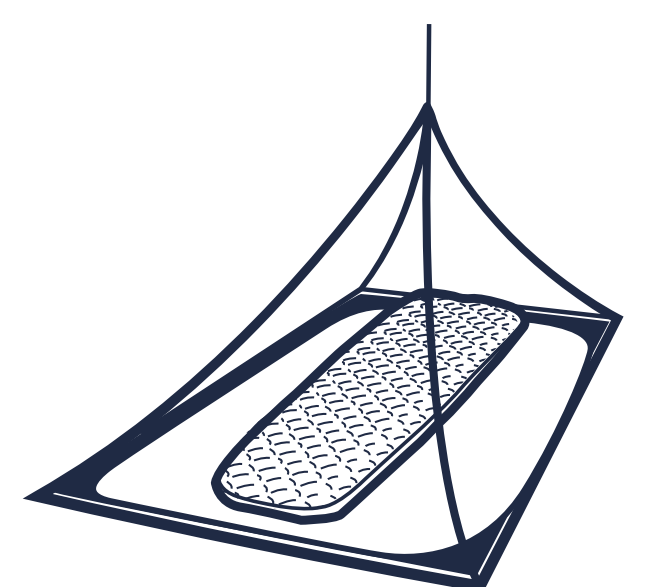

INSECT PROTECTION SHELTERS

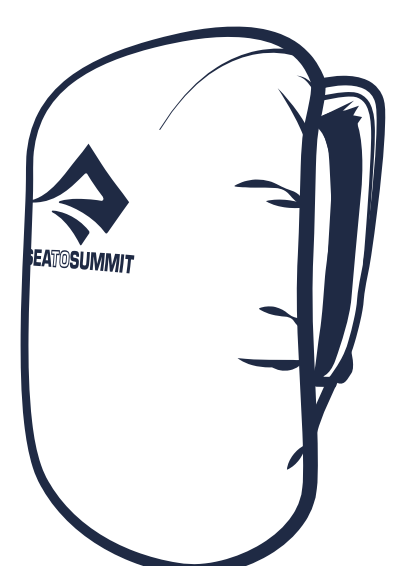

PACK + RAIN PROTECTION

# TOWELS THAT TRAVEL

Our packable towels earn their place in your backpack or carry-on. They're lighter, more compact and will dry faster to keep you on the move.

## DRY+ FABRIC

A fast-drying, recycled fabric that won't hold onto water like traditional cotton towels.

## HANDY STORAGE

All towels come with a handy storage sack or case to make packing easier.

## EXTRA ABSORBANT

Technical fabrics hold up to six times their own weight in water.

## EASY DRYING

Hang Loop with press stud closure for easy drying.

## EASY CARE

All of our towels are machine washable.

## SOFT HAND-FEEL

Lightweight technical materials with soft finishes.

DRY+



# EXPLORE THE RANGE

LIGHTWEIGHT			DELUXE
			
AIRLITE TOWEL	POCKET TOWEL	DRYLITE TOWEL	TEK TOWEL

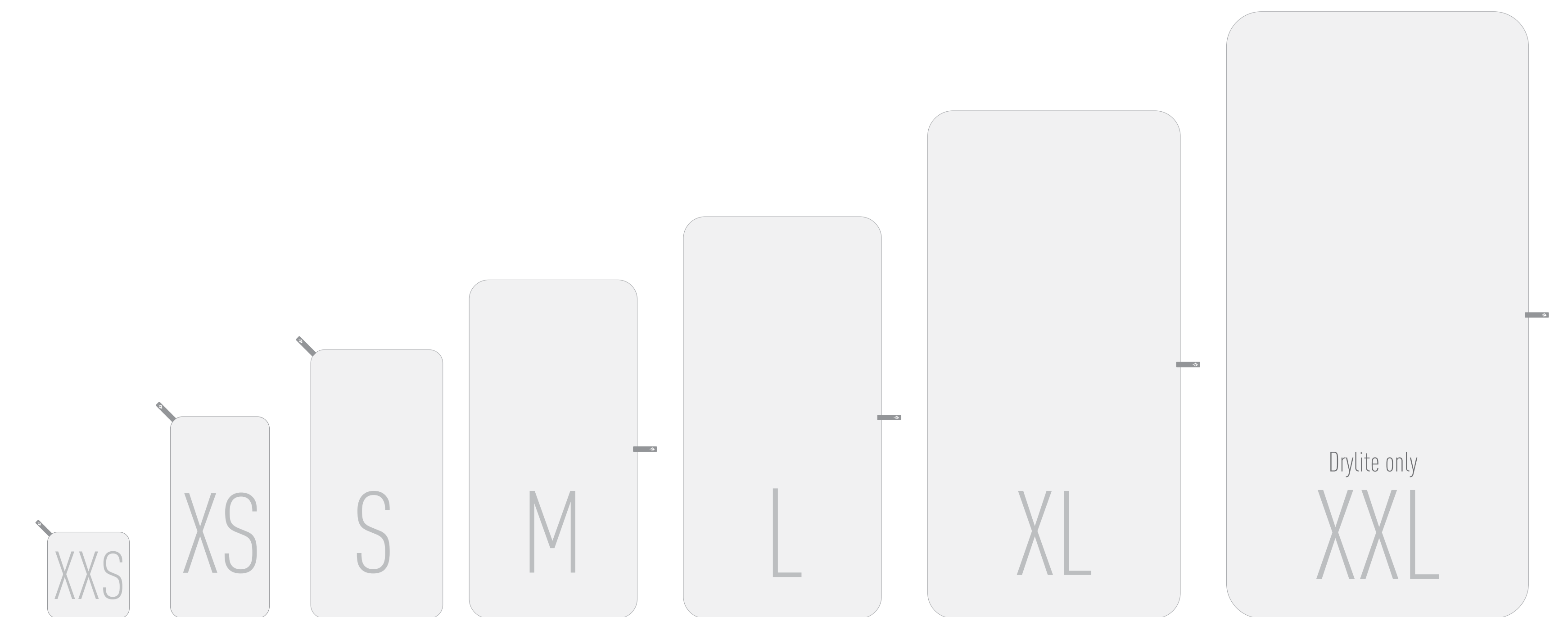



# COLOURS + PATTERNS

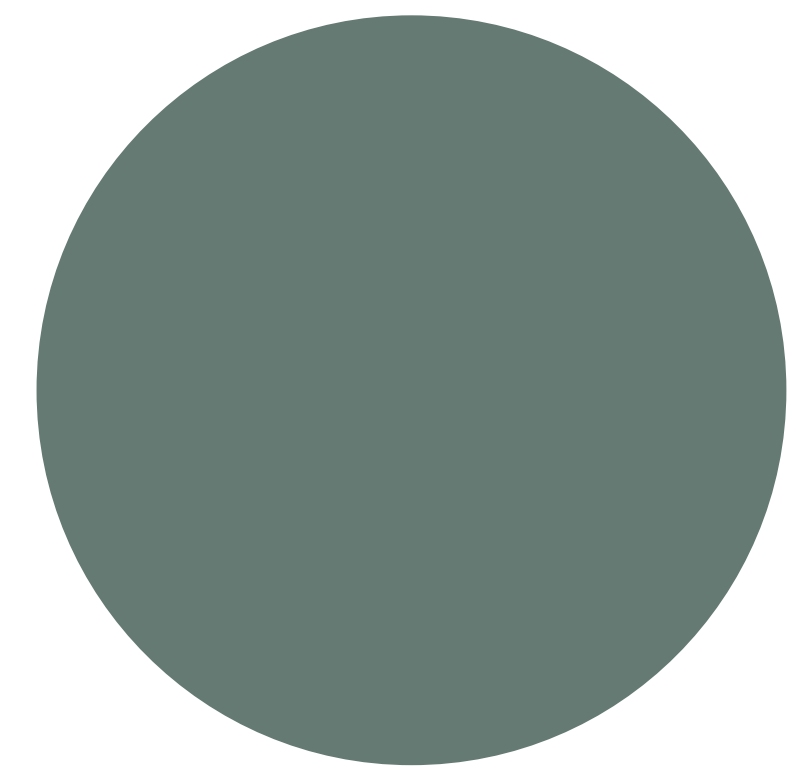

SAGE

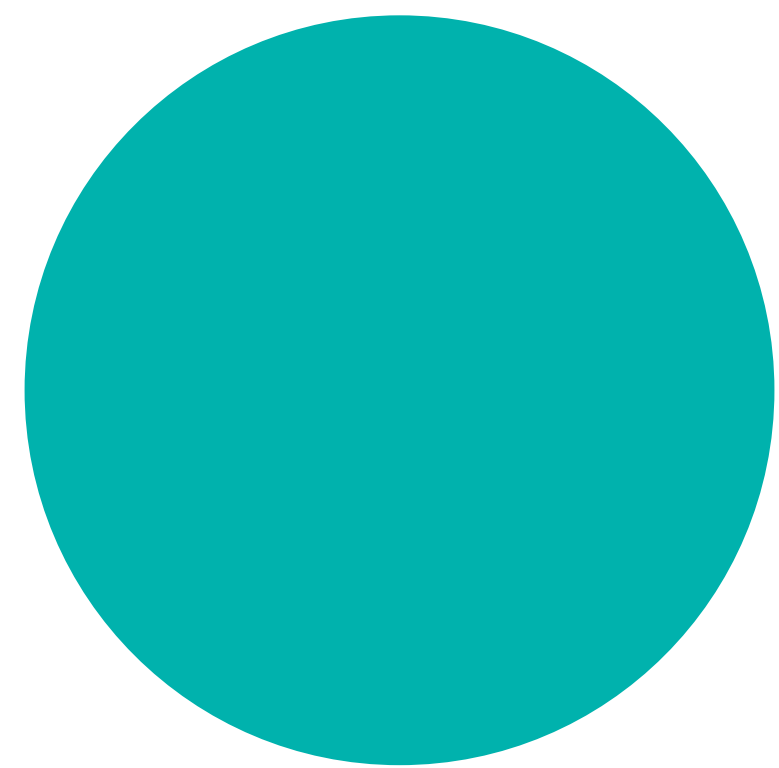

BALTIC

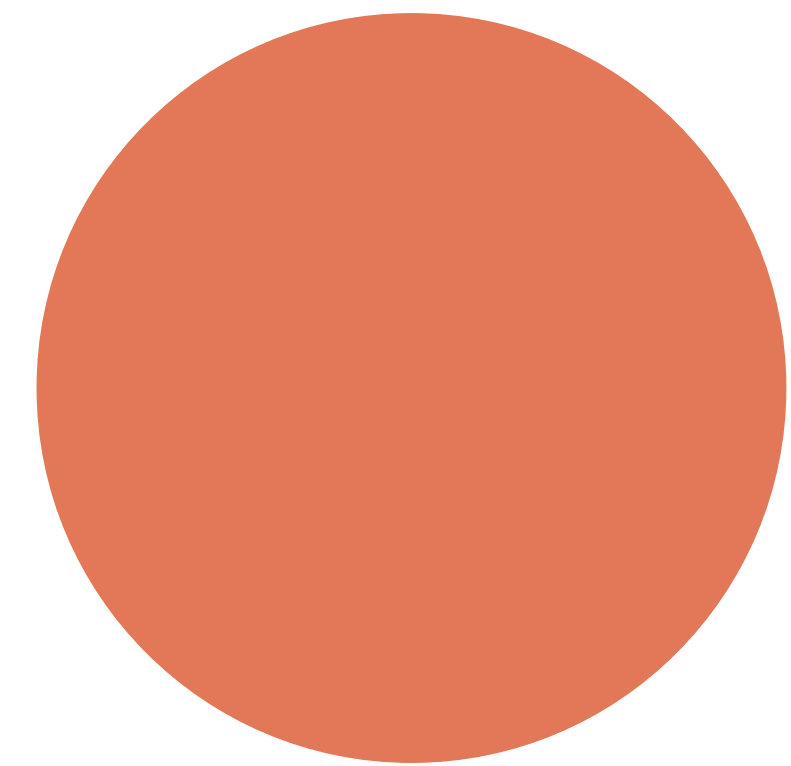

OUTBACK

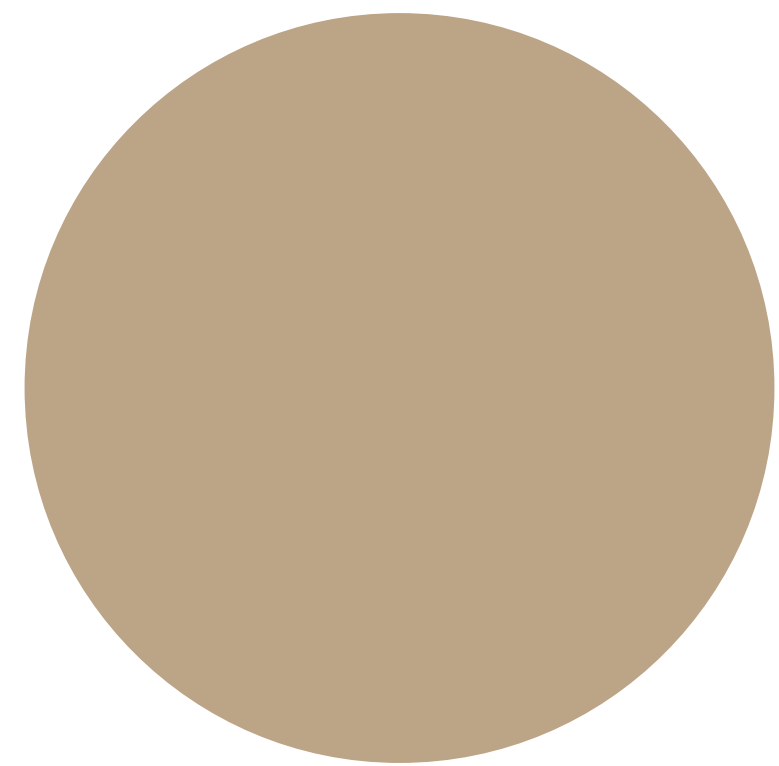

DESERT

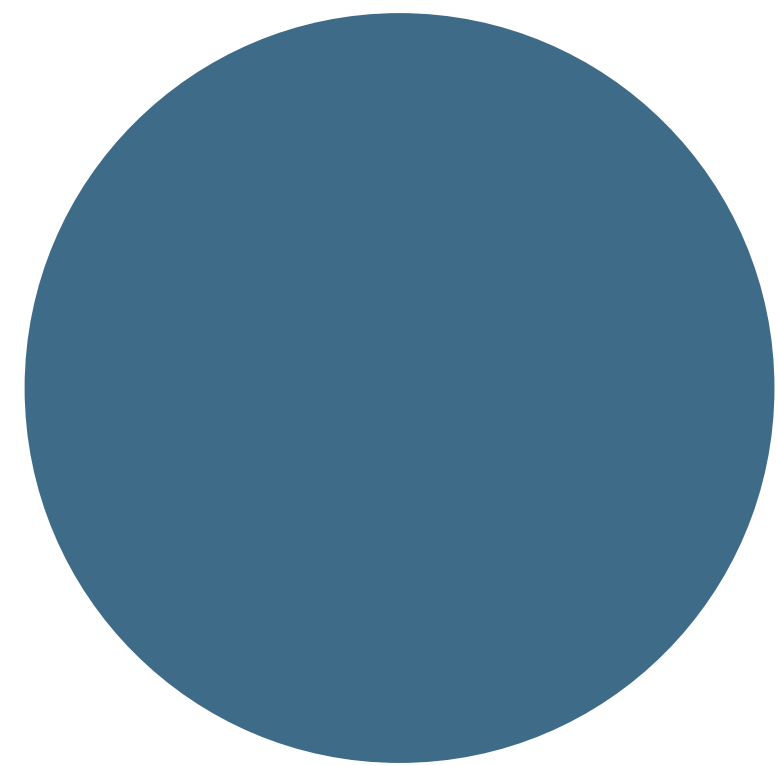

MOONLIGHT

## PATTERNS AVAILABLE IN DRYLITE TOWELS



ATLANTIC WAVE



OUTBACK SUNSET



DESERT WIND



BEACH BLUE



**SUSTAINABLE DESIGN**  
80% Recycled Polyester

## DRYLITE TOWEL

The perfect hostel travel towel—compact, super soft, absorbent and fast-drying.

### FEATURES

- Suede woven fabric reduces weight and speeds up drying time, while still giving a soft hand feel.
- Remarkably absorbent and fast-drying
- Very packable—it's lighter and more compact than our Tek Towel

SIZES XS / S / M / L / XL / XXL

### COLOURS

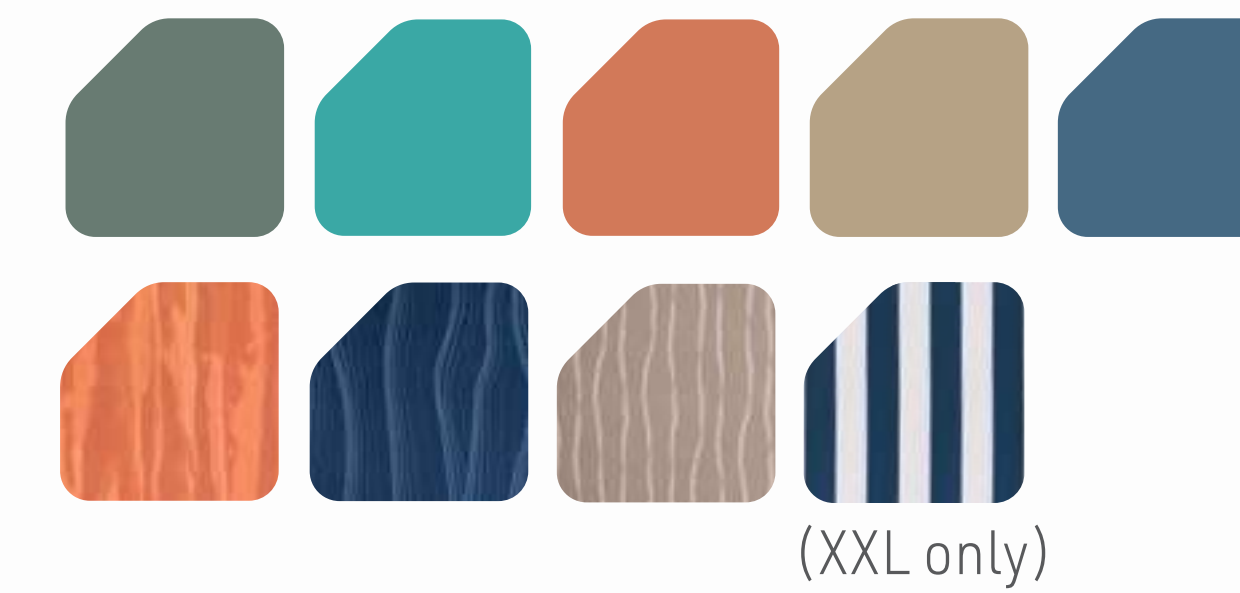





## AIRLITE TOWEL

Lightweight, super compact and exceptionally fast drying, our minimalist Airlite Towel won't slow you down.

### FEATURES

- 50% lighter than our Pocket Towel
- Perfect for sweat management when on the trail or during exercise.



SIZES XXS / S / M / L



**SUSTAINABLE DESIGN**  
85% Recycled Polyester



## POCKET TOWEL

Travel with one and you're home and dry in a jiffy.

### FEATURES

- Absorbs up to three times its own weight in water.



SIZES XS / S / M / L / XL



**SUSTAINABLE DESIGN**  
100% Recycled Polyester



## TEK TOWEL

Super absorbent, quick drying towel with that at-home terrycloth feel.

### FEATURES

- A classic terry towel knit fabric creates a soft, plush towel that can absorb over six times its own weight in water.



SIZES XS / S / M / L / XL



**SUSTAINABLE DESIGN**  
80% Recycled Polyester



### LIGHTWEIGHT TOWELS

PRODUCT NAME	CODE	SIZE	DIMENSIONS	WEIGHT	STORAGE	MATERIALS	COLOUR	RRP
Drylite Towel	ACP071031-03	XS	60 x 30cm	37g	Mesh Faced Storage Pouch with a hook and loop closure	Recycled Polyester - 80% Polyamide-20%		
	ACP071031-04	Small	80 x 40cm	62g				
	ACP071031-05	Medium	100 x 50cm	100g				
	ACP071031-06	Large	120 x 60cm	145g				
	ACP071031-07	XL	150 x 75cm	230g				
	ACP071031-08	XXL	17 x 85cm	495g			(XXL only)	
Airlite Towel	ACP071011-02	XXS	36 x 36cm	12g	Stuff Sack with Drawcord Closure	Recycled Polyester - 85% Polyamide -15%		
	ACP071011-04	Small	80 x 40cm	30g				
	ACP071011-05	Medium	100 x 50cm	47g				
	ACP071011-06	Large	120 x 60cm	67g				
Pocket Towel	ACP071051-04	Small	80 x 40cm	58g	EVA case with zipper closure	Recycled Polyester - 100%		
	ACP071051-05	Medium	100 x 50cm	80g				
	ACP071051-06	Large	120 x 60cm	110g				
	ACP071051-07	XLarge	150 x 75cm	175g				

### DELUXE TOWELS

PRODUCT NAME	CODE	SIZE	DIMENSIONS	WEIGHT	STORAGE	MATERIALS	COLOUR	RRP
Tek Towel	ACP072011-03	XS	60 x 30cm	80g	EVA case with zipper closure	Recycled Polyester - 80% Polyamide-20%		
	ACP072011-04	Small	80 x 40cm	120g				
	ACP072011-05	Medium	100 x 50cm	200g				
	ACP072011-06	Large	120 x 60cm	285g				
	ACP072011-07	XL	150 x 75cm	445g				

# PERSONAL CARE



# EXPLORE THE RANGE

CLEANING WIPES	LIQUID SOAPS	PAPER SOAPS
		



## WILDERNESS WIPES

Wilderness Wipes will clean and refresh you when a shower, or even just water, isn't a possibility. The extra thick viscose non-woven fibre is soft and gentle on your skin, pH balanced and readily compostable after use.

### FEATURES

- Resealable packet

SIZES COMPACT / XL





## WILDERNESS WASH

Our super-concentrated Wilderness Wash goes a long way—it's gentle on fabrics and skin but effective on dishes and laundry stains.

### FEATURES

- Super-concentrated biodegradable formula
- Tough bottle with lid insert and secure cap, so it will not leak in your pack or bag
- Safe for personal use, pots, pans, clothes and outdoor gear

SIZES 50ML / 100ML / 250ML





## TREK AND TRAVEL LIQUID SOAPS

Fitting easily into cabin baggage or an expedition pack, our Trek & Travel Liquid Soaps will spruce up everything from hair and body to clothes. The made-to-travel, leak-proof bottle is TSA carry-on compliant and the biodegradable formula is environmentally friendly.

### FEATURES

- Ideal for travelling and camping
- Concentrated formula

SIZES 100ML





## TREK AND TRAVEL POCKET SOAPS

These palm-sized pocket soaps will spruce up everything from hair, to body, to clothes.

### FEATURES

- Biodegradable and Environmentally friendly

SIZES 50 LEAVES



## WILDERNESS WASH POCKET SOAP

Multi-purpose outdoors dry leaf wash-leak-free convenience anywhere.

### FEATURES

- Fragrance-free and biodegradable

SIZES 50 LEAVES







### CLEANING WIPES

PRODUCT NAME	CODE	SIZE	DIMENSIONS	WEIGHT	MATERIALS	RRP
Wilderness Wipes	AWWC	Compact 12 pack	20 x 16cm	93g	Refer to the ingredients list on packaging	
	AHY4192-00121002	Compact 36 pack		292g		
	AWWXL	XLarge 8 pack	30 x 20cm	122g		

### LIQUID SOAPS

PRODUCT NAME	CODE	SIZE	DIMENSIONS	WEIGHT	MATERIALS	RRP
Wilderness Wash	AHY4029-00121003	50ml	11 x 4.5 x 2.5cm	63g	Refer to the ingredients list on packaging	
	AHY4029-00121004	100ml	11 x 6 x 2.5cm	115g		
	AWW250	250ml	14 x 8 x 4cm	295g		
Wilderness Wash Citronella	AHY4029-00121005	50ml	11 x 4.5 x 2.5cm	63g	Refer to the ingredients list on packaging	
	AHY4029-00121006	100ml	11 x 6 x 2.5cm	115g		
	AWWC250	250ml	14 x 8 x 4cm	295g		



### LIQUID SOAPS

PRODUCT NAME	CODE	SIZE	DIMENSIONS	WEIGHT	MATERIALS	RRP
Trek & Travel Liquid Body Wash	ACP063021-041401					
Trek & Travel Liquid Conditioning Shampoo	ACP063041-041402	100ml	11 x 6 x 2.5cm	115g	Refer to the ingredients list on packaging	
Trek & Travel Liquid Laundry Wash	ACP063051-041403					

### PAPER SOAPS

PRODUCT NAME	CODE	SIZE	DIMENSIONS	WEIGHT	MATERIALS	RRP
Trek & Travel Pocket Body Wash	ATTPBW					
Trek & Travel Pocket Conditioning Shampoo	ATTPCS	50 leaves	6.5 x 4.5 x 1.5cm	14g	Refer to the ingredients list on packaging	
Trek & Travel Pocket Hand Wash	ATTPHW					
Trek & Travel Pocket Laundry Wash	ATTPLW					
Wilderness Wash Pocket Soap	APSOAP	50 leaves	6.5 x 4.5 x 1.5cm	14g	Refer to the ingredients list on packaging	

# UTILITY + CONVENIENCE



# EXPLORE THE RANGE

## WASH UP SOLUTIONS



CLOTHESLINE



POCKET SHOWER

## LEAVE NO WASTE



POCKET TROWEL ALLOY



POCKET TROWEL NYLON 66



ULTRA-SIL OUTHOUSE



## THE CLOTHESLINE

Quick and easy to set-up no stretch, no peg, adjustable length clothesline.

### FEATURES

- Clothesline measures 3.5 metres
- Dual cord with beads holds garments in place, even in the wind



## POCKET SHOWER

Enjoy a well-earned eight minute shower at the end of a long sweaty day in the outdoors.

### FEATURES

- Contoured shower head provides generous and even spray dispersion
- Simple and easy-to-use twist mechanism for turning on/off and for flow adjustment



**70D** WATERPROOF FABRIC





## POCKET TROWEL ALLOY

Our super strong Alloy Pocket Trowel is a durable, lightweight and compact carry-anywhere trekking trowel.

### FEATURES

- Storage space in handle for a lighter or toilet paper



## POCKET TROWEL NYLON 66

Minimise your backcountry impact with this compact and lightweight camping trowel.

### FEATURES

- Storage space in handle for lighter or toilet paper
- Withstands extremely cold temperatures



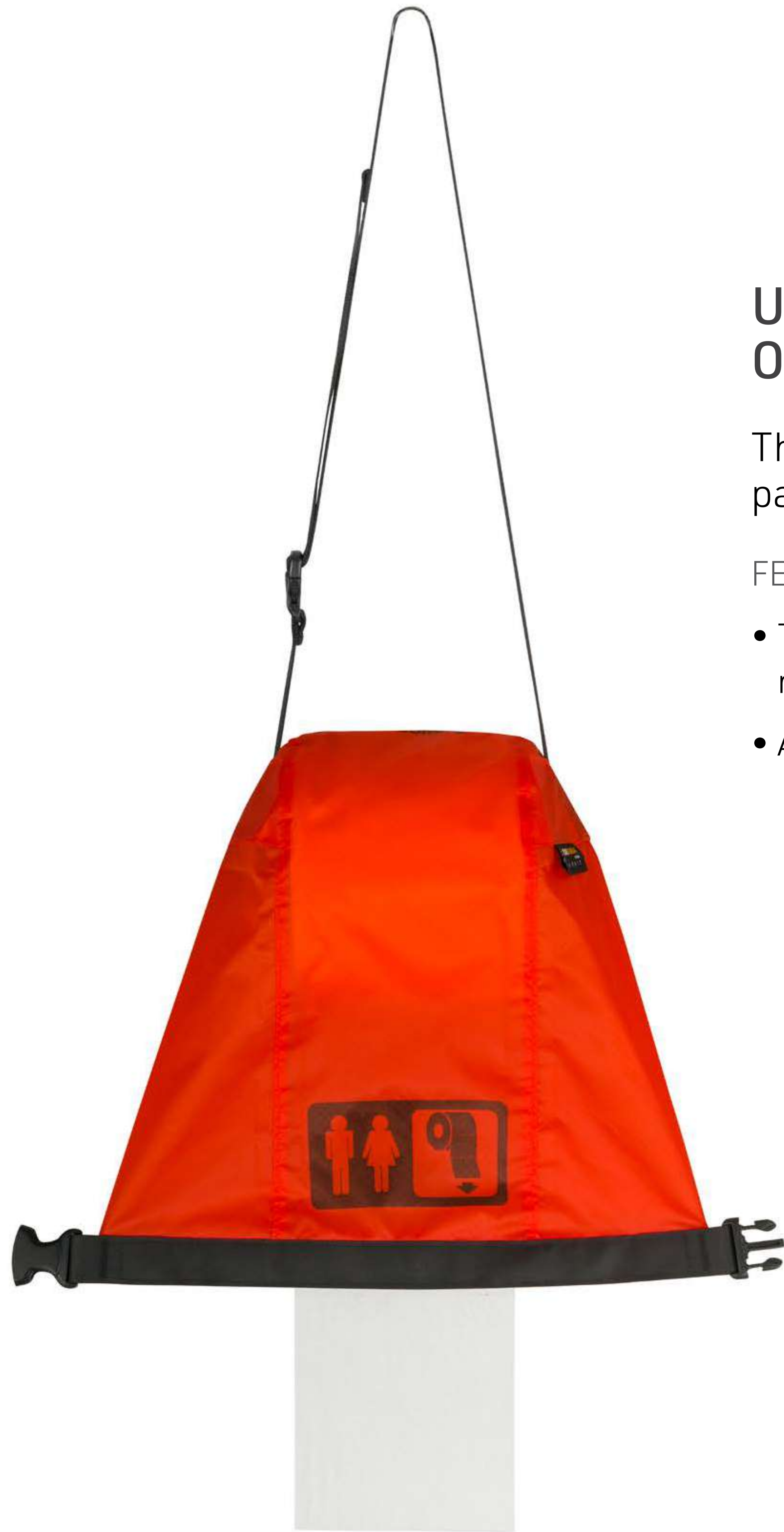

## ULTRA-SIL OUTHOUSE

There's nothing more useless than wet toilet paper—keep yours dry and accessible.

### FEATURES



- Toilet paper is suspended inside by a stiffening rod that allows the paper to dispense smoothly
- Accommodates full size toilet roll

30 D ULTRA-SIL







## WASH UP SOLUTIONS

PRODUCT NAME	CODE	SIZE	WEIGHT	MATERIALS	RRP
 The Clothesline	ACLOTH	350cm	25g	Polyester cord, neoprene pouch	
 Pocket Shower	APSHOWER		120g	70D PU-coated Nylon	

## LEAVE NO WASTE

PRODUCT NAME	CODE	DIMENSIONS	WEIGHT	MATERIALS	RRP
 Pocket Trowel Alloy	APTROWEL	24.5 x 6.5 x 3cm	100g	Hard-anodised alloy blade, anodised alloy shaft	
 Pocket Trowel Nylon 66	ASTOOL	25 x 6.5 x 3cm	87g	Glass-reinforced Nylon 66	
 Ultra-Sil Outhouse	AOH		50g	30D Nylon	



# GAITERS



# EXPLORE THE RANGE

GAITERS					ANKLE GAITERS		ACCESSORIES
ALPINE EVENT	QUAGMIRE EVENT	QUAGMIRE CANVAS	OVERLAND	GRASSHOPPER	SPINIFEX	TUMBLEWEED	REPLACEMENT STRAPS

EUR	37	38	39	40	41	42	43	44	45	46	47						
BOOT SIZE UK	4	4.5	5	5.5	6	6.5	7	7.5	8	8.5	9	9.5	10	10.5	11	11.5	12
US	5	5.5	6	6.5	7	7.5	8	8.5	9	9.5	10	10.5	11	11.5	12	12.5	13
GAITER SIZE	SMALL			MEDIUM				LARGE			X-LARGE						



# GAITERS

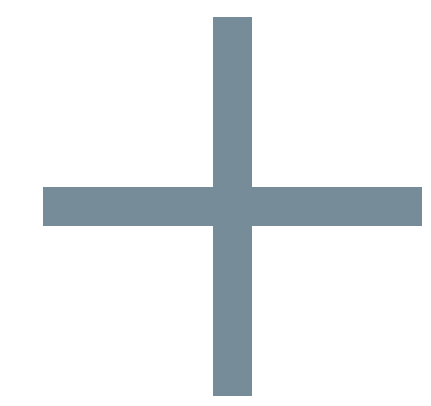

## OUR GAITERS FEATURE:

### FRONT OPENING

Hook-and loop adjustable front opening gives fantastic fit, easy access and shin protection.

### LACE HOOK

Made with 316 grade stainless steel.

### REPLACEABLE STRAP/CORD

Removable and replaceable underfoot strap or cord secures the gaiter around the instep.

### NON-PFC

All fabrics use a CO DWR which is non-PFC.



## ALPINE GAITERS

Trimmed down for speed and lightweight appeal.

SIZES S / M / L / XL



**SUSTAINABLE DESIGN**  
CO Non-PFC Water Repellent Finish



## QUAGMIRE EVENT® GAITERS

Breathable eVent® panels and shin-protecting front opening—the perfect all-season backcountry gaiter.

SIZES S / M / L / XL



**SUSTAINABLE DESIGN**  
CO Non-PFC Water Repellent Finish



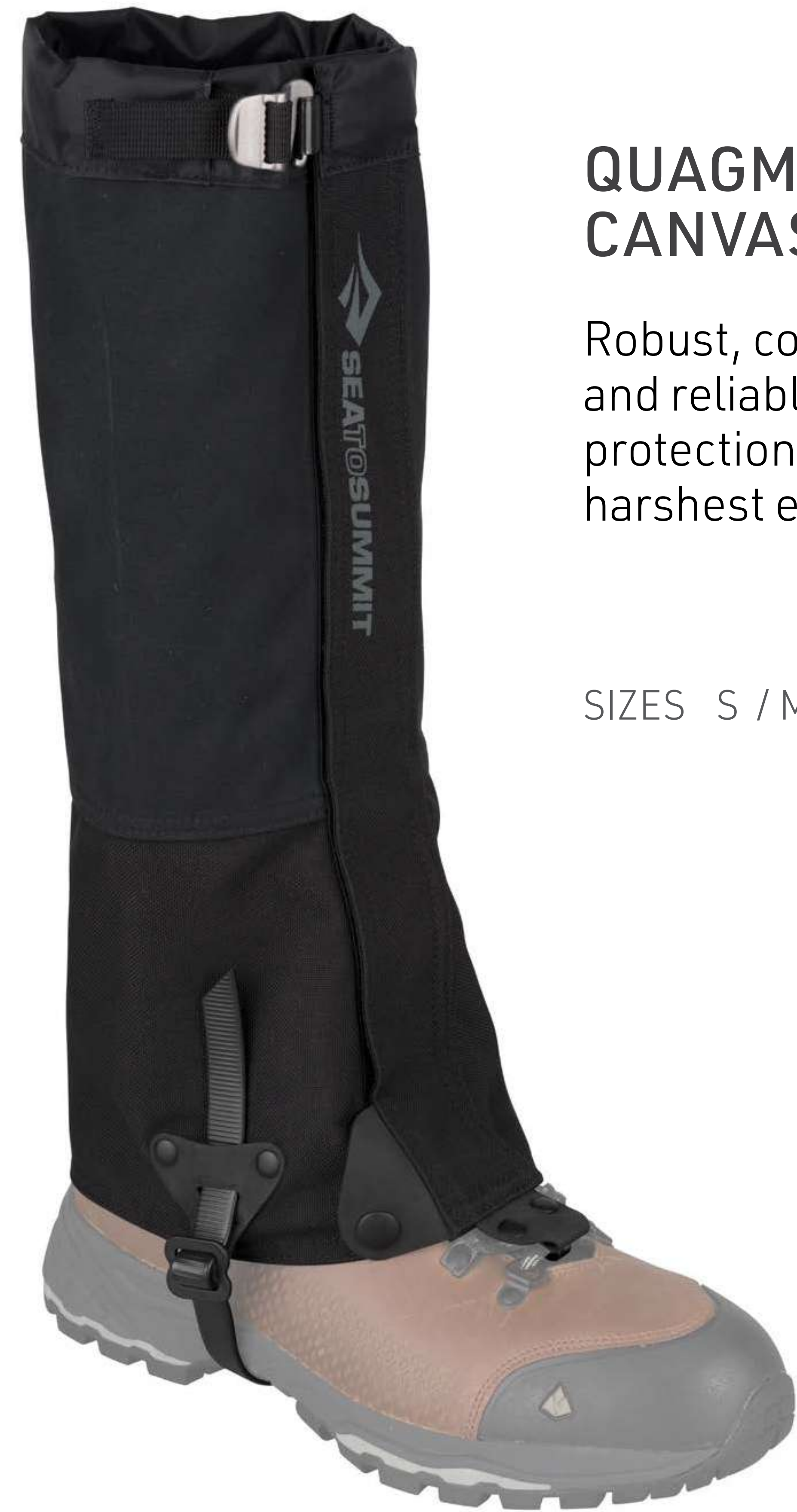

### QUAGMIRE CANVAS GAITERS

Robust, comfortable and reliable lower leg protection in even the harshest environments.

SIZES S / M / L / XL



**SUSTAINABLE DESIGN**  
CO Non-PFC Water Repellent Finish

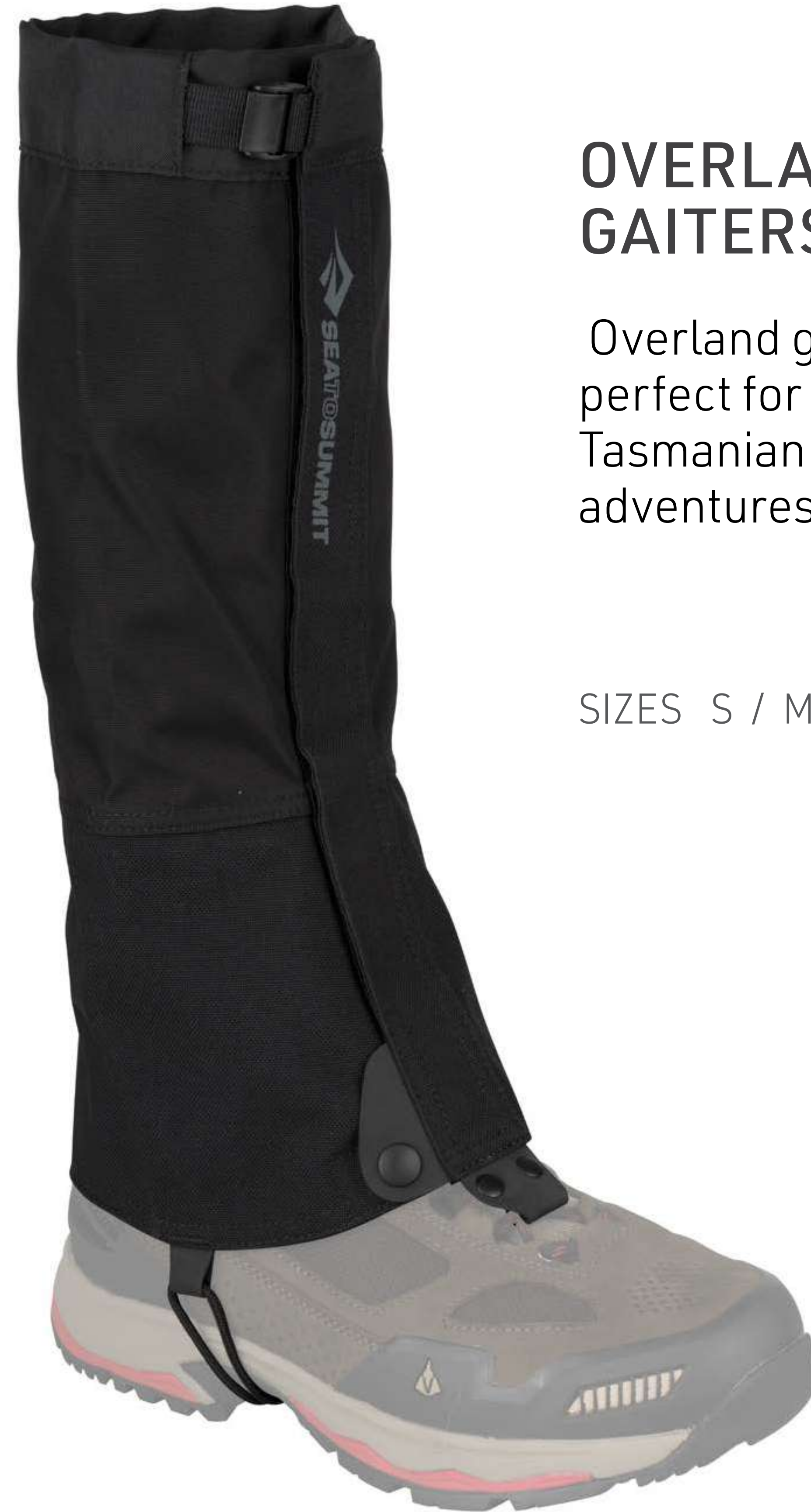

### OVERLAND GAITERS

Overland gaiters are perfect for their namesake Tasmanian track and adventures beyond.

SIZES S / M / L / XL



**SUSTAINABLE DESIGN**  
CO Non-PFC Water Repellent Finish



### GRASSHOPPER GAITERS

Our Grasshopper Gaiter is a straightforward, great value-for-money choice that are robust, easy to put on and easily adjusted.

SIZES S/M L/XL



**SUSTAINABLE DESIGN**  
CO Non-PFC Water Repellent Finish



### SPINIFEX ANKLE GAITERS

This heavy-duty, minimalist gaiter will guard your socks and ankles from stones, sticks, seeds and sand.

#### FEATURES

- Available in 450D Polyester or 8oz Canvas

SIZES ONE SIZE



### TUMBLEWEED ANKLE GAITERS

The Tumbleweed is designed for use with adventure sport shoes to keep mud, sand, stones and seeds out. Regardless of whether you're running Tasmania's Overland Track in a day, mowing the lawn or spreading mulch in the garden, these gaiters are perfect.

SIZES S/M L/XL



### GAITER STRAPS REPLACEMENT PAIR

Our replacement gaiter straps are made of super hard-wearing, pressure injected, high density webbing.







## KNEE GAITERS

PRODUCT NAME	CODE	SIZE	TO FIT BOOT SIZE	WEIGHT	MATERIALS	RRP
Alpine Gaiters	ACP012042-040101	Small	37-40	250g	Upper: eVent® fabric Lower: 1000D Nylon	
	ACP012042-050102	Medium	39-42	265g		
	ACP012042-060103	Large	41-45	280g		
	ACP012042-070104	XL	43-47	295g		
Quagmire eVent® Gaiters	ACP012052-040101	Small	37-40	300g	Upper: eVent® fabric Lower: 1000D Nylon	
	ACP012052-050102	Medium	39-42	325g		
	ACP012052-060103	Large	41-45	345g		
	ACP012052-070104	XL	43-47	360g		
Quagmire Canvas Gaiters	ACP012012-040101	Small	37-40	310g	Upper: 8oz Canvas Lower: 1000D Nylon	
	ACP012012-050102	Medium	39-42	330g		
	ACP012012-060103	Large	41-45	350g		
	ACP012012-070104	XL	43-47	370g		
Overland Gaiters	ACP012022-040101	Small	37-40	210g	Upper: 450D polyester Lower: 1000D Nylon	
	ACP012022-050102	Medium	39-42	225g		
	ACP012022-060103	Large	41-45	240g		
	ACP012022-070104	XL	43-47	260g		
Grasshopper Gaiters	ACP012032-040101	S/M	37-42	185g	450D polyester	
	ACP012032-060102	L/XL	41-47	205g		



## ANKLE GAITERS

PRODUCT NAME	CODE	SIZE	TO FIT BOOT SIZE	WEIGHT	MATERIALS	RRP
 Spinifex Ankle Gaiters	CANVAS	ACP011022-130101	One Size	One Size	170g	8oz canvas
	POLYESTER	ACP011012-130101				
 Tumbleweed Ankle Gaiters	ACP011022-040101	S/M	37-42	110g	228T Taslan Nylon	
	ACP011022-060102	L/XL	41-47	120g		

## GAITER ACCESSORIES

PRODUCT NAME	CODE	DIMENSIONS	WEIGHT	MATERIALS	RRP
 Gaiter Straps Replacement Pair	AGSR	38 x 1.5 x 0.3cm	394g	Pressure-injected Polyester webbing	

# INSECT PROTECTION





# INSECT PROTECTION CLOTHING

## HEAD NETS



MOSQUITO HEADNET



NANO  
MOSQUITO HEADNET



ULTRA-MESH  
MOSQUITO HEADNET



# HEAD NETS



## OUR HEAD NETS FEATURE:

### MAXIMUM VISIBILITY

Black mesh offers better visibility than white mesh.

### COMFORTABLE

Made with soft fibres.

### EASY TO USE

Elasticised neck drawcord closure.

### HANDY STORAGE

Packaged in a handy stuff sack or pouch.



## HEAD NET

When the bugs are thick, wearing a head net is the answer.

### FEATURES

- Fine woven 80 hole/cm<sup>2</sup> hexagonal mesh
- Wide enough to wear with a hat or without



**80 HOLES** per cm



## 15D ULTRA-MESH

## ULTRA-MESH HEAD NET

Keep even the smallest insects at bay—including no-see-ums, sand-flies and midges.

### FEATURES

- Ultra-fine 310 hole/cm<sup>2</sup> (2000 holes/in<sup>2</sup>) hexagonal mesh



**310 HOLES** per cm



## 15D ULTRA-VIS

## NANO HEAD NET

No one wants bugs on their face—this tiny head net is the answer.

### FEATURES

- 15D Ultra-Vis 80 hole/cm<sup>2</sup> hexagonal mesh
- Lightest and smallest insect head net available



**80 HOLES** per cm





## HEAD NETS

PRODUCT NAME	CODE	WEIGHT	MATERIALS	COLOUR	RRP
Head Net	AMOSH	30g	50D Polyester Mesh		
Head Net - Permethrin Treated	AMOSHP				
Nano Head Net	ANMOSH	11g	15D Nylon Mesh		
Nano Head Net - Permethrin Treated	ANMOSHP				
Ultra-Mesh Head Net	AUMOSH	23g	15D Nylon Mesh		

# INSECT PROTECTION SHELTERS



# INSECT PROTECTION SHELTERS

*Permethrin*  
Treated Mosquito Nets



## OUR INSECT PROTECTION SHELTERS FEATURE:

### MAXIMUM VISIBILITY

Black mesh offers better visibility than white mesh.

### MOSQUITO PROTECTION

Minimum 80 holes/cm<sup>2</sup> = far finer than WHO recommendations for mosquito protection.

### EASY SET UP

Colour coded corners for easy setup and elasticised hanging cord minimises snagging and aids in height adjustment.

### PRACTICAL

Asymmetrical hanging point gives practical headroom, while elasticised hem secures net under mat for extra protection.

### HANDY STORAGE

Individual stuff sacks to help keep your gear organised.



## NANO MOSQUITO PYRAMID NET

Ultra-lightweight and compact protection from mosquitoes and other bugs.

SIZES SINGLE / DOUBLE



80 HOLES per cm

15D ULTRA-VIS



## MOSQUITO PYRAMID NET

Protect your sleeping self from pesky bugs—they might see you, but they can't get to you.

SIZES SINGLE / DOUBLE



80 HOLES per cm



## INSECT PROTECTION SHELTERS

PRODUCT NAME	CODE	SIZE	DIMENSIONS	WEIGHT	MATERIALS	RRP
 Nano Mosquito Pyramid Net	ANMOSD	Double	240 x 170 x 130cm	137g	15D mono-filament Nylon	
	ANMOSS	Single	221 x 122 x 107cm	82g		
 Mosquito Pyramid Net	AMOSS	Single	221 x 122 x 107cm	240g	50D multi-filament polyester	
	AMOSD	Double	240 x 170 x 130cm	340g		

# PACK + RAIN PROTECTION





# EXPLORE THE RANGE

PACK COVERS	PONCHOS		
 <p data-bbox="859 1140 1069 1243">ULTRA-SIL PACK COVER</p>	 <p data-bbox="1439 1140 1705 1243">ULTRA-SIL NANO PONCHO</p>	 <p data-bbox="1825 1140 2092 1243">ULTRA-SIL NANO TARP PONCHO</p>	 <p data-bbox="2269 1140 2492 1243">NYLON TARP PONCHO</p>



## ULTRA-SIL PACK COVER

A super-lightweight pack cover you can trust.

### FEATURES

- No-seam construction for water resistance
- Keeper strap (sizes S-L) pulls the pack cover tight across the pack harness

SIZES XS / S / M / L

COLOURS  



**30 D** ULTRA-SIL





**15D ULTRA-SIL**



## ULTRA-SIL NANO PONCHO

Compact and super-lightweight rain protection—for hiking or the football.

### FEATURES

- Press studs offer the alternative of closing sides when in use

COLOURS



**70D WATERPROOF FABRIC**



## NYLON TARP PONCHO

Two-in-one versatility for rain protection on the trail.

### FEATURES

- Accommodates a large backpack
- Easily converts from rainwear to a two-person shelter
- Double stitched, tape sealed, three-panel hood

COLOURS



## ULTRA-SIL NANO TARP PONCHO

Our Ultra-Sil Nano Tarp Poncho is a raincoat, pack cover, groundsheet and tarp all in one. An ideal solution in temperate climates and can be used as an emergency shelter if needed.

### FEATURES

- Siliconised outer surface won't wet out

COLOURS





## PACK COVERS

PRODUCT NAME	CODE	SIZE	FITS PACK SIZE	DIMENSIONS	WEIGHT	MATERIALS	COLOUR	RRP
Ultra-Sil Pack Cover	APCSILXS	Extra Small	15-30L	66 x 26 x 25cm	57g	30D PU-coated, siliconised CORDURA® Nylon		
	APCSILS	Small	30-50L	62 x 40 x 20cm	85g			
	APCSILM	Medium	50-70L	78 x 35 x 30cm	113g			
	APCSILL	Large	70-95L	94 x 43 x 35.5cm	130g			

## PONCHOS

PRODUCT NAME	CODE	DIMENSIONS	WEIGHT	MATERIALS	COLOUR	RRP
Ultra-Sil Nano Poncho	APONSTD15D	140 x 118cm	150g	15D PU-coated, siliconised Nylon		
Ultra-Sil Nano Tarp Poncho	APONCHO15D	265 x 145cm	230g			
Nylon Tarp Poncho	APONCHO	253 x 137cm	408g	70D PU-coated Nylon		

# STRAPS + TRANSPORT ACCESSORIES





# STRAPS + TRANSPORT ACCESSORIES

ROBUST, DURABLE DESIGNS  
THAT STAND THE TEST OF TIME.

## REPAIRABLE BUCKLES

Buckles lead a tough life, and sometimes the unexpected happens. But our Field Repair Buckle can be permanently replaced in seconds using only a screwdriver - no wonder it won a German Design Award.

## FUNCTIONAL, DURABLE, AND INNOVATIVE

Soft Roof Racks and various tie-downs: all engineered to ensure that what you attach to your vehicle, stays on your vehicle.

## STRAPS FOR A VARIETY OF FUNCTIONS

From ski touring to bike tours, bikepacking to backpacking, paddlesports to VanLifers, we have the perfect straps to help you secure a variety of objects to racks and frames. Let our commitment to detail allow you to kick back and enjoy a bit of Aussie fun on your next adventure. We've got you covered

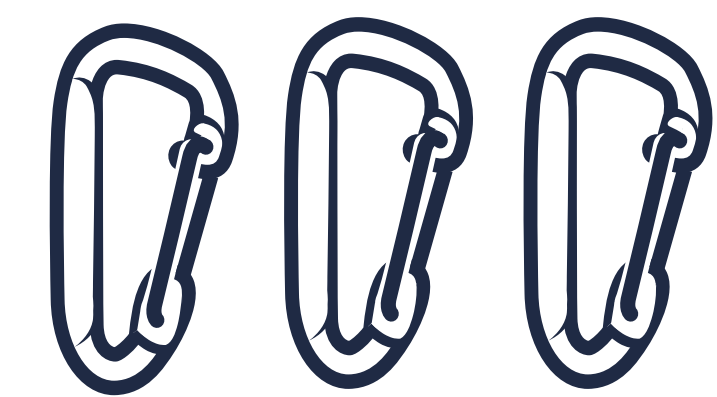

ATTACHMENT  
ACCESSORIES



STRAPS



FIELD REPAIR  
ACCESSORIES

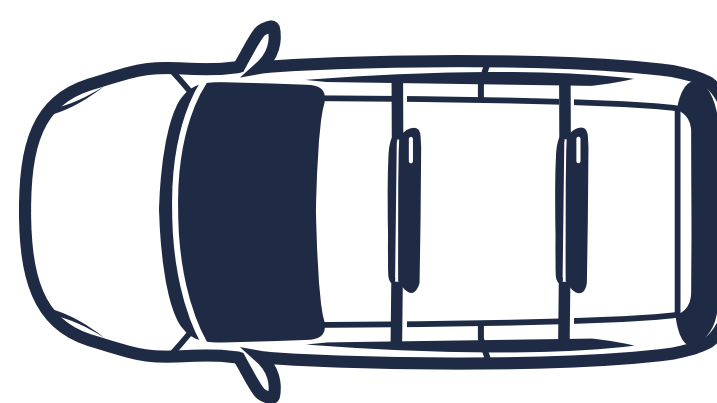

ROOF ACCESSORIES

# ATTACHMENT ACCESSORIES



## LIGHTWEIGHT + STRONG

Anodised aluminium alloy body, steel wiregate.

## QUICKLY SECURE

Easy-to-use spring-steel wiregate design.

## STAY ORGANISED

Keep your keys at-hand and secure items in place.

\*NON-RATED. NOT FOR CLIMBING.



## LARGE ACCESSORY CARABINER

### FEATURES

- Two-piece Titanium Grey pack



## SMALL ACCESSORY CARABINER 3-PIECE

### FEATURES

- Three-piece pack in three different colours (grey, blue, orange)



## CARABINERS





PRODUCT NAME	CODE	SIZE	DIMENSIONS	WEIGHT	MATERIALS	COLOUR	RRP
Accessory Carabiner Large	ATD0140-00122101	Large	7.5 x 4.5 x 0.6cm	13g			
Accessory Carabiner Small	AABINER3	3pce set	4 x 2.3 x 0.3cm	9g	anodised aluminium alloy body, spring-steel wiregate		



# STRAPS



# EXPLORE THE RANGE

TPU STRAPS	ACCESSORY STRAPS	TIE-DOWN STRAPS	
 <p data-bbox="363 1071 583 1118">STRETCH-LOC</p>	 <p data-bbox="1136 1071 1442 1118">ACCESSORY STRAPS</p>	 <p data-bbox="2079 1071 2372 1118">BOMBER TIE-DOWN</p>	 <p data-bbox="2655 1071 2982 1168">TIE-DOWN WITH SILICONE CAM COVER</p>



## STRETCH-LOC TPU STRAPS

Easy-to-use, strong and versatile straps for securing gear—simply stretch, lock and move on.

### FEATURES

- Attach, bundle together or compress most items
- Two or more straps can be joined to increase length
- Keeper Strap provides quick release attachment, extra grip and retains excess strap

WIDTHS 12MM / 20MM

LENGTHS 300MM / 450MM / 375MM / 500MM / 625MM / 750MM

COLOURS

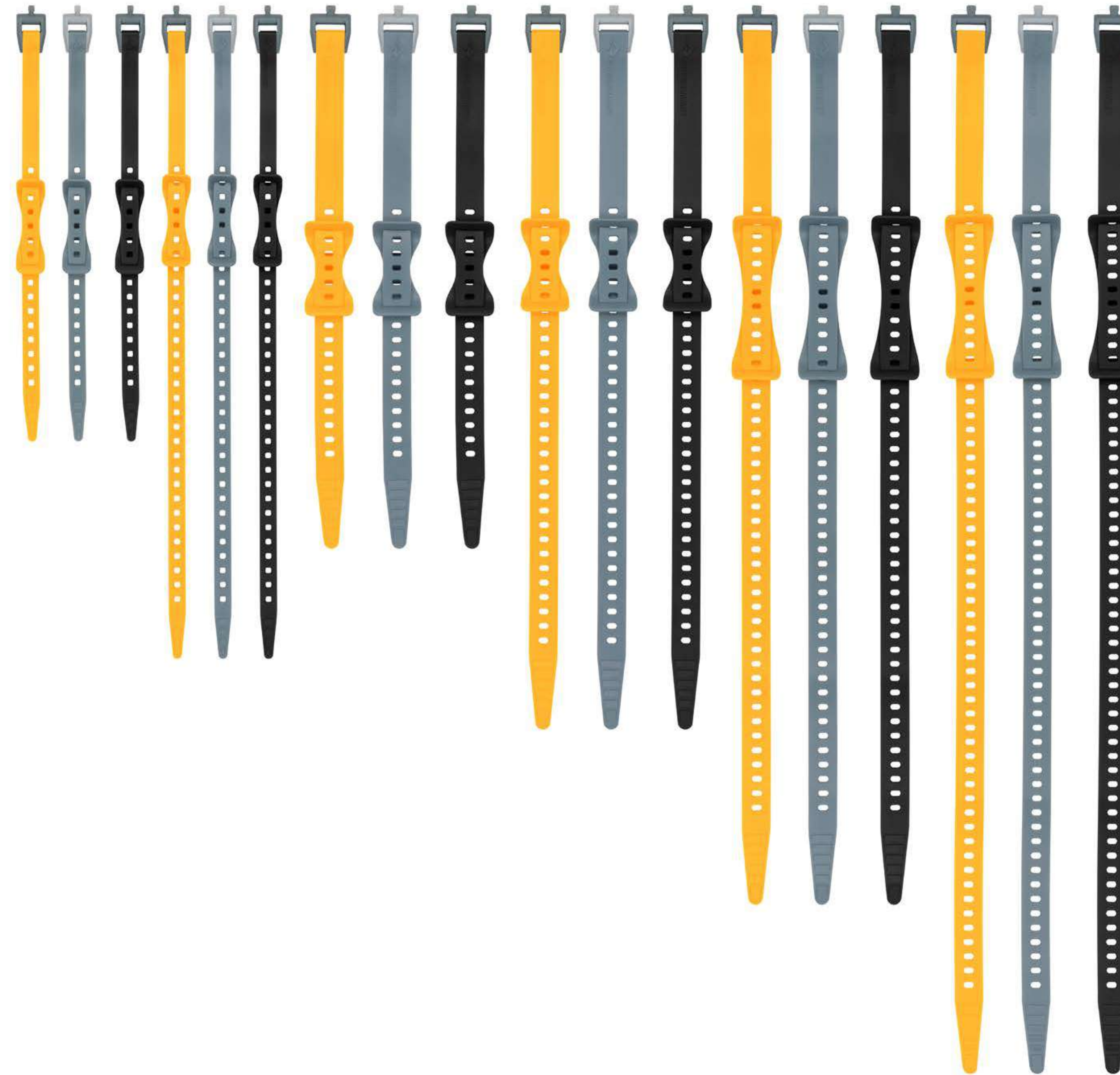

Grippy TPU

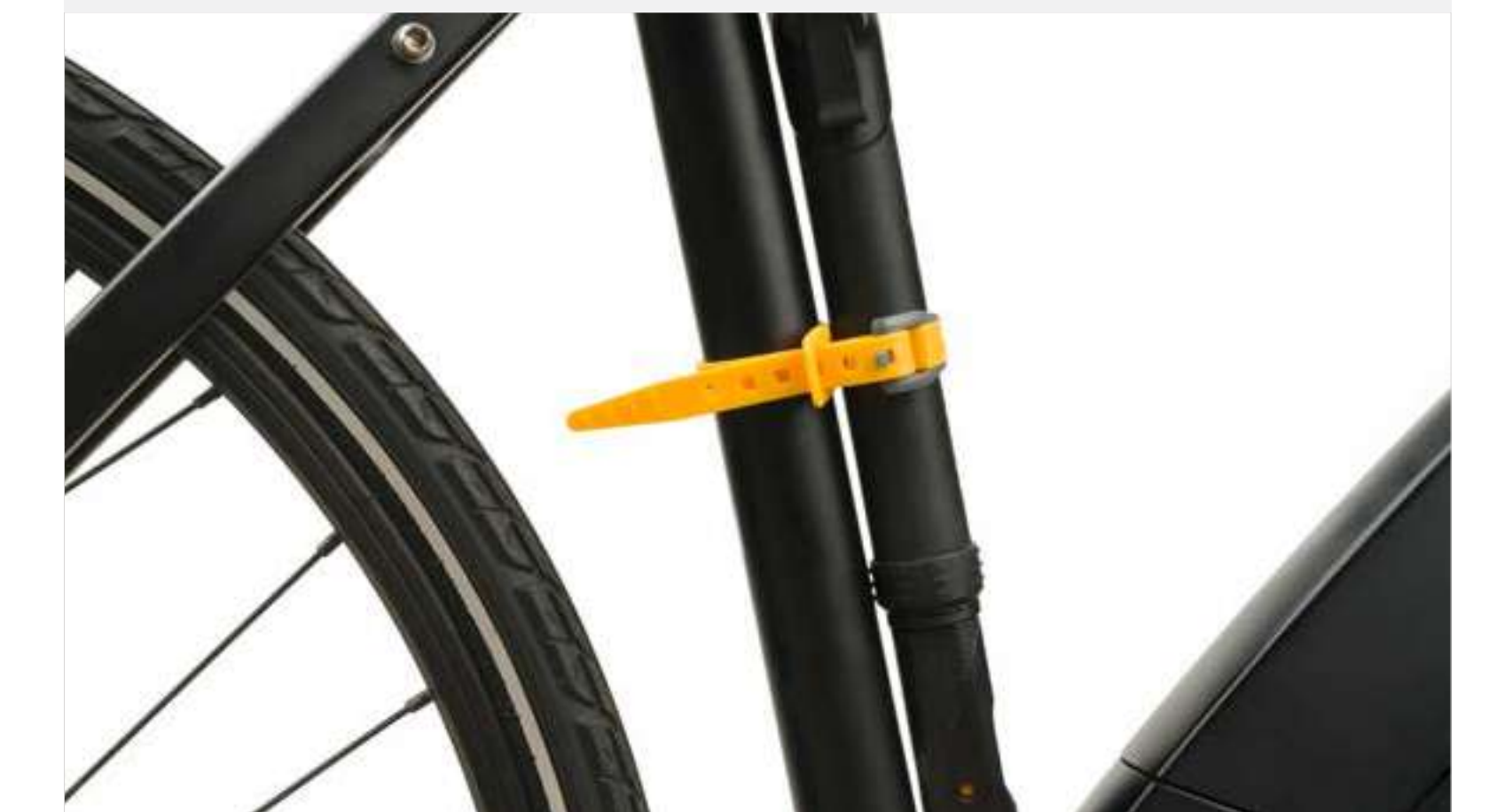

Keeper strap retains excess strap



Strong, secure strap with non-slip buckle



Easy and fast to tension and lockup



## ACCESSORY STRAPS

Lightweight and versatile straps for lashing gear together or attaching to your pack, deck or bag.

### FEATURES

- High load rating
- Comes with either a simple ladder lock, or a quick release hook buckle.

WIDTHS 10MM / 20MM

LENGTHS 1M / 1.5M / 2M

COLOURS  



## BOMBER TIE-DOWN

All-purpose tie-down strap with silicone protector pad.

### FEATURES

- Integrated elastic strap-keeper for neat storage
- Available in three colour-coded lengths: 2m (lime), 3m (orange) and 4m (blue)

SIZES 2M / 3M / 4M

COLOURS  



## TIE-DOWN WITH SILICONE CAM COVER

Hands down the best cam-buckle tie-down you can buy. The silicone cam cover protects your boat or car from the absolutely secure and rugged metal buckle.

### FEATURES

- Colour-coded according to size
- Integrated elastic strap-keeper for neat storage

SIZES 3.5M / 4.5M / 5.5M

COLOURS  



## STRETCH-LOC STRAPS

PRODUCT NAME	CODE	SIZE	DIMENSIONS	WEIGHT	MATERIALS	COLOUR	RRP
Stretch-Loc 12 (2 pack)	ASLSTRP12X300	12mm	300mm	15g (ea)	TPU		
Stretch-Loc 17 (2 pack)	ASLSTRP12X450		450mm	18g (ea)			
Stretch-Loc 15 (2 pack)	ASLSTRP20X375	20mm	375mm	26g (ea)			
Stretch-Loc 20 (2 pack)	ASLSTRP20X500		500mm	32g (ea)			
Stretch-Loc 25 (2 pack)	ASLSTRP20X625		625mm	39g (ea)			
Stretch-Loc 30 (2 pack)	ASLSTRP20X750	750mm	45g (ea)				
Stretch-Loc (4 pack - 20mm, mixed lengths)	ASLSTRP4PCK	20mm	375, 500, 625 & 750mm				

## ACCESSORY STRAPS

PRODUCT NAME	CODE	SIZE	BUCKLE TYPE	DIMENSIONS	MATERIALS	COLOUR	RRP
Hook Release Accessory Strap	ATDASH101.0	10mm	Hook Release	1m	Polypropylene webbing, anodised aluminium alloy buckles		
	ATDASH101.5			1.5m			
	ATDASH102.0			2m			
	ATDASH201.0	20mm		1m			
	ATDASH201.5			1.5m			
	ATDASH202.0			2m			



### TIE-DOWN STRAPS

PRODUCT NAME	CODE	SIZE	WEIGHT	MATERIALS	COLOUR	RRP
Bomber Tie-down (Single)	SOLBTD2	2m	115g	UV-stabilised polyester webbing, die-cast alloy buckle, silicone rubber protector		
	SOLBTD3	3m	126g			
	SOLBTD4	4m	137g			
Tie-down with Silicone Cam Cover (Pair)	SOLDSCDP35	3.5m	500g	UV-stabilised polyester webbing, die-cast alloy buckle, silicone rubber protector		
	SOLDSCDP45	4.5m	550g			
	SOLDSCDP55	5.5m	620g			

# FIELD REPAIR ACCESSORIES





Side Release - 1 Pin



Ladderlock - 1 Pin

## FIELD REPAIR BUCKLE

Our Field Repair Buckles provide an easy repair solution for broken or worn out buckles-no need to sew in a replacement buckle once your adventure's over.

### FEATURES

- Strong, corrosion resistant stainless steel pins

SIZES 15MM / 20MM / 25MM / 38MM / 50MM



Side Release - 2 Pin



Side Release - 2 Ladderlock



## REFLECTIVE ACCESSORY CORD

Perfect to use as guy lines for tarps and tents, laundry line, a hang piece for your drink bottle lid or pocket knife. Made from hydrophobic polyester, the cord won't soak up water and stretch.

### FEATURES

- Super bright reflective tracer
- Tight weave resists tangling

SIZES 10M (Ø1.8MM) / 5M (Ø3MM)





## FIELD REPAIR BUCKLES

PRODUCT NAME	CODE	SIZE	MATERIALS	RRP
 Ladderlock - 1 Pin	AFRB15LLP	15mm	POM, stainless-steel pins	
	AFRB20LLP	20mm		
	AFRB25LLP	25mm		
 Side Release - 1 Pin	AFRB15SRPA	15mm	POM, stainless-steel pins	
	AFRB20SRPA	20mm		
	AFRB25SRPA	25mm		
	AFRB38SRPA	38mm		
	AFRB50SRPA	50mm		
 Side Release - 2 Ladderlock	AFRB15SR	15mm	POM, stainless-steel pins	
	AFRB20SR	20mm		
	AFRB25SR	25mm		
	AFRB38SR	38mm		
	AFRB50SR	50mm		
 Side Release - 2 Pin	AFRB15SRPP	15mm	POM, stainless-steel pins	
	AFRB20SRPP	20mm		
	AFRB25SRPP	25mm		
	AFRB38SRPP	38mm		
	AFRB50SRPP	50mm		

## CORD

PRODUCT NAME	CODE	SIZE	DIMENSIONS	WEIGHT	MATERIALS	RRP
 Reflective Accessory Cord	ARC10M	1.8mm	10m	19g	Polyester	
	ARC5M	3mm	5m	26g		

# ROOF ACCESSORIES





## TRAVELLER SOFT RACKS

An quick and easy system for transporting different sized watercraft or even a lumber purchase from the hardware store. The unique daisy chain design lets you change the position of your tie down to be as close as possible to the sides of whatever object you are carrying. This makes for a more secure load, with less chance of slipping.

### FEATURES

- Wide footprint to disperse load on the roof
- Carries canoes, kayaks, sit-on-tops, surfboards, SUPs, skis, snowboards and other equipment

SIZES R / L





Grippy base reduces risk of movement



Super strong, removable daisy chain



## FOAM ROOF RACKS

PRODUCT NAME	CODE	SIZE	DIMENSIONS	WEIGHT	MATERIALS	COLOUR	RRP
 Traveller Soft Racks	ATSR	Regular	86 x 19 x 8cm	1800g	Nylon face fabric, closed-cell foam, UV-stabilised polyester webbing, die-cast alloy buckle, silicone rubber protector		
	SOLTSRL	Large	110 x 19 x 8cm	2460g			

# WATERSPORTS





# WATERSPORTS

## WATERSPORTS HAVE NEVER BEEN MORE ENJOYABLE.

### STORAGE TO WATERLINE

Continuously tested in the Australian outback and other demanding environments worldwide, Sea to Summit has all the essentials for paddling adventures, whatever the situation or season.

### TRANSPORT SOLUTIONS FROM CAR PARK TO LAUNCH

Our Carts and Sit-on-Top Carts make moving your canoe or kayak simple, whether it is a couple of hundred meters from your parking place, or a kilometer or two on a portage.

### WATERPROOF DECK ORGANISATION

Our products provide easy access to on-the-water essentials and waterproof storage solutions for the deck of a SUP or similar craft.

### SAFETY AND ACCESSORIES

From paddles that remain attached to your craft if you lose your grip, to pumps that quickly remove water, to paddle floats with built-in whistles to seek help and storage bags that keep your gear dry.

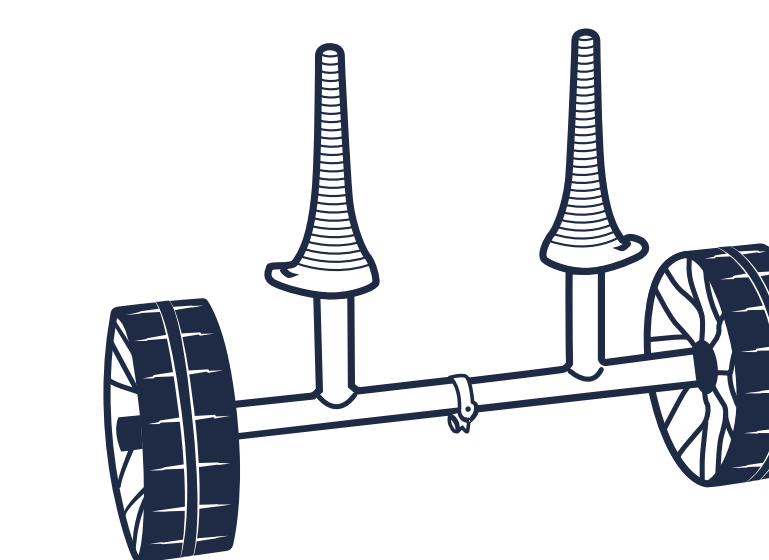

**STORAGE +  
TRANSPORT**

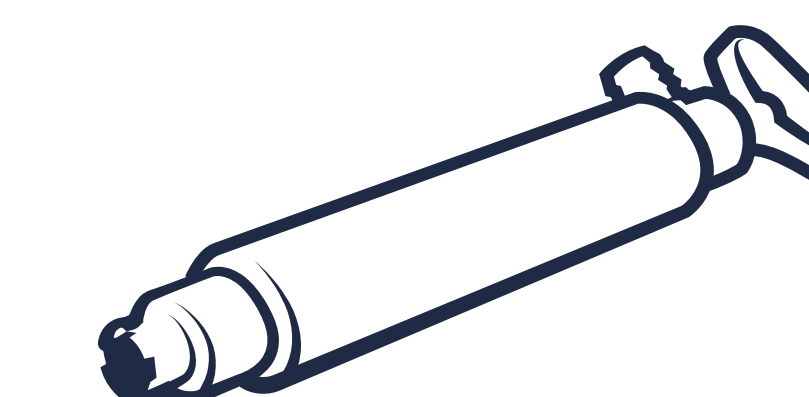

**PADDLE  
ACCESSORIES**

# STORAGE + TRANSPORT



# EXPLORE THE RANGE

## BOAT + BOARD TRANSPORT



CART FOR WATERCRAFT



SIT-ON-TOP CART



AQUASLING



AQUARACKS





## CART FOR WATERCRAFT - SOLID WHEELS

Our Solid Wheel Cart is the ideal choice for portages or transporting your kayak or canoe from the car to the water.

### FEATURES

- Durable, lightweight and compact construction
- Built in tie-down with easy feed webbing

SIZES    S / M

COLOURS     



Stainless steel pins



Oversized anodised 6063-t6 alloy tubing



Hypalon retainers for increased strength



## SIT-ON-TOP CART - SOLID WHEELS

Our Solid Wheel Sit-on-Top Cart is a unique kayak cart that is universal in application and robust enough to cater to a large range of sit-on-top kayaks.

### FEATURES

- Lightweight, innovative design

### COLOURS



Adjustable axle width from 180-400mm



Tapered rubber cones to fit scuppers from 24-48mm



Puncture-proof solid wheels offer great soft terrain performance



## AQUASLING

Sling your watercraft onto your wall with ease.

### FEATURES

- Simple design allows a single person to easily access and store their craft
- Ideal for SUPs and surfboards
- Great for indoor and outdoor applications
- Easy to install—complete mounting hardware and instructions included



## AQUARACKS

Aquaracks can accommodate virtually any paddle craft on the market and allow for storage at almost any angle without causing damage. They are a great way to store your boats in the garage, gear shed or favourite room at home.

### FEATURES

- Specially designed padded arms prevent damage or depressions to the hull and finish
- Suitable for indoor or outdoor applications

SIZES REG

COLOURS





### BOAT + BOARD TRANSPORT

PRODUCT NAME	CODE	SIZE	DIMENSIONS	WEIGHT	MATERIALS	COLOUR	RRP
Cart - Solid Wheels	SOLCARTM	Medium	79 x 36 x 15cm	2.9 kg	Anodised aluminium tubing, glass-reinforced polypropylene wheels, thermoplastic rubber wheel surfaces		
	SOLCARTS	Small	66 x 31 x 15cm	3.3 kg			
Sit-on-Top Cart - Solid Wheels	SOLSOTG				Anodised aluminium tubing, glass-reinforced polypropylene wheels, thermoplastic rubber wheel surfaces		







### BOAT + BOARD STORAGE

PRODUCT NAME	CODE	SIZE	CAPACITY	DIMENSIONS	WEIGHT	MATERIALS	COLOUR	RRP
Aquasling	SQSLINGBL			220 x 5.5 x 2cm	430g	Reinforced Nylon straps, EVA foam, Nylon hook and 'D' Ring		
Aquaracks (Pair)	SQRACKYW	Regular	80kg	84 x 45 x 4cm	2520g			

# PADDLE ACCESSORIES



# EXPLORE THE RANGE

SAFETY GEAR		WATERPROOF DECK BAGS	PERSONAL
			
PADDLE KEEPER	BILGE PUMP	ACCESS DECK BAG	ECLIPSE GLOVES
			
PADDLE LEASH	PADDLE FLOAT	SUP DECK BAG	



## PADDLE KEEPER

Our Paddle Keeper is the perfect solution for keeping your paddle attached to your kayak or canoe when resting, fishing or during the occasional swim. Can also be used as a fishing rod lanyard.

### FEATURES

- Suits standard shaft diameter range of 28-32mm
- Double hook-and-loop paddle shaft attachment that doubles back for enhanced security



## PADDLE LEASH

Lightweight paddle leash for both sea and kayak fishing.

### FEATURES

- Stretchy inner cord for more flexibility
- Hook-and-loop closure on durable, non-slip strap for security



## BILGE PUMP

A must have for any open water paddler, our Bilge Pump is a quick and effective way to empty water from your kayak or canoe.

### FEATURES

- High-volume, double action pump extracts 400ml per pump
- Full-length high visibility foam with reflective logo aids recovery



## INFLATABLE PADDLE FLOAT

This single chamber inflatable paddle float can be used in conjunction with a paddle to stabilise a kayak in the event of a capsize, making re-entry easier.

### FEATURES

- Easy access from deck during emergency - just pull the red tab





## ACCESS DECK BAG

Our Access Deck Bag offers easy access to essentials like a camera, sunscreen, and snacks without exiting your kayak. With two different systems, it's also super simple to attach without needing to add any cord or extra attachment points.

### FEATURES

- Curved, water-resistant zip
- A 70D drybag is also secured internally to provide complete waterproofness for the internal contents.
- Two methods of securing to your kayak: hook-and-loop strips on the base, or side release buckles on the sides



## SUP DECK BAG

While it was designed for Stand Up Paddleboards, there's also no reason to limit yourself to SUPs—this bag is equally useful on all manner of kayaks, boats, and rafts.

### FEATURES

- Non-wicking roll-top closure
- Lash points can be secured to your craft with 3M brand self-adhesive.
- Strong durable loops for attaching gear externally



## ECLIPSE GLOVES

Grab your fingerless Eclipse Gloves for excellent UV protection when paddling.

### FEATURES

- UPF50+ for protection against the sun
- 2mm neoprene cuff with hook-and-loop closure helps maintain flexibility in the wrist

SIZES SM / MED / LGE / XL







## SAFETY GEAR

PRODUCT NAME	CODE	SIZE	DIMENSIONS	WEIGHT	MATERIALS	COLOUR	RRP
Paddle Leash	SOLPLEASH	110-190cm		34g	Nylon sheath, rubber bungee cord		
Paddle Keeper	SOLPKEEPER	110-240cm			Nylon webbing		
Bilge Pump	SOLBILGE			340g	ABS plastic cylinder, anodised aluminium alloy shaft		
Inflatable Paddle Float	SOLIPF		40 x 28 x 18cm	215g	420D PU-coated Nylon		

## DECK BAGS

PRODUCT NAME	CODE	SIZE	DIMENSIONS	WEIGHT	MATERIALS	COLOUR	RRP
Access Deck Bag	ARDKBBL		37 x 18 x 10cm	520g	420D TPU-laminated Nylon, 70D PU-coated Nylon internal dry bag		
SUP Deck Bag 12L	AWS015021-05	12L	36 x 28 x 15cm	340g	420D TPU-laminated Nylon, aircraft-aluminium alloy buckles		

## GLOVES

PRODUCT NAME	CODE	SIZE	WEIGHT	RRP
Eclipse Gloves	SOLEGS	Small	34g	
	SOLEGM	Medium	37g	
	SOLEGL	Large	39g	
	SOLEGXL	XL	42g	

 **SEAT@SUMMIT**

